

RoHS Compliant Product

## Description

The SQ2163 series of positive, linear regulators feature low quiescent current (30µA typ.) with low dropout voltage, making them ideal for battery applications. These rugged devices have both Thermal Shutdown, and Current Fold-back to prevent device failure under the "Worst" of operating conditions. In applications requiring a low noise, regulated supply, place a 1000pF capacitor between Bypass and Ground. The SQ2163 is stable with an output capacitance of 2.2µF or greater.

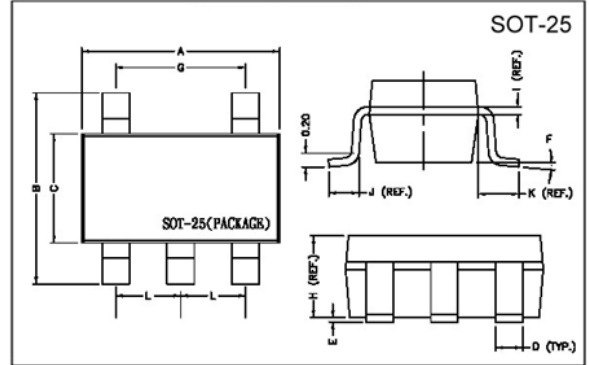

REF.	Millimeter		REF.	Dimensions
	Min.	Max.		Millimeter
A	2.70	3.10	G	1.90 REF.
B	2.60	3.00	H	1.20 REF.
C	1.40	1.80	I	0.12 REF.
D	0.30	0.55	J	0.37 REF.
E	0	0.10	K	0.60 REF.
F	0°	10°	L	0.95 REF.

## Features

- \* High Accurate  $\pm 1.5\%$
- \* Over-Temperature Shutdown
- \* Factory Pre-set Output Voltage
- \* Very Low Dropout Voltage
- \* Noise Reduction Bypass Capacitor
- \* Short Circuit Current Fold-back
- \* Guaranteed 300mA output
- \* Current Limiting
- \* Power-Saving Shutdown Mode

## Applications

- \* PC Peripherals
- \* Wireless Devices
- \* Portable Electronics
- \* Battery Powered Widgets
- \* Electronic Scales
- \* Instrumentation
- \* Cordless Phones

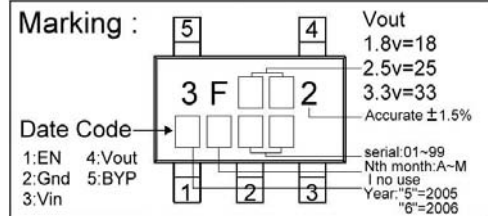

## Typical Application Circuit

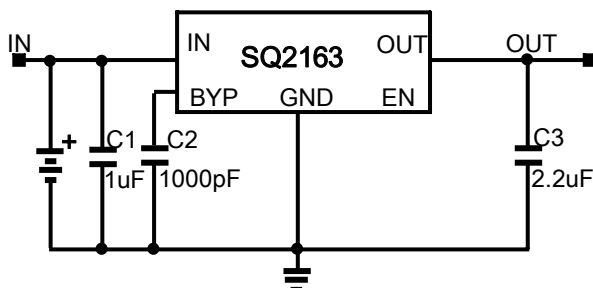

## Functional Block Diagram

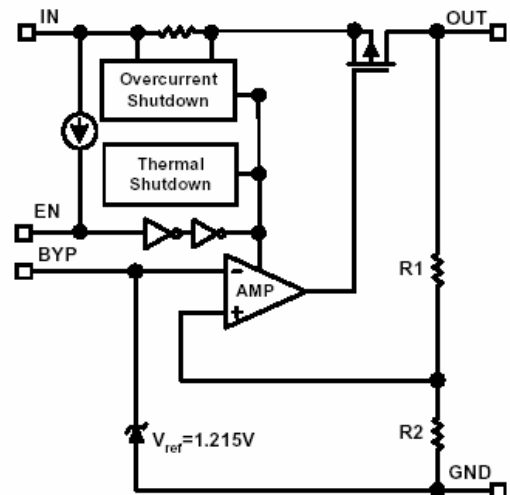

## Absolute Maximum Ratings

Parameter	Symbol	Ratings	Unit
Input Voltage	V <sub>IN</sub>	8	V
Output Current	I <sub>OUT</sub>	P <sub>D</sub> /(V <sub>IN</sub> -V <sub>O</sub> )	mA
Output Voltage	V <sub>OUT</sub>	1.5~5.0	V
Operating Ambient Temperature	T <sub>opr</sub>	-40~+85	°C
Junction Temperature	T <sub>j</sub>	-40~+125	°C
Max. Junction Temperature	T <sub>j</sub> Max.	150	°C
Power Dissipation (Δ T=100°C)	P <sub>D</sub>	380	mW
EDS Classification		B	

## Electrical Characteristics Ta=25°C unless otherwise noted

Parameter	Symbol	Min.	Typ.	Max.	Unit	Condition
Output Voltage	V <sub>OUT(E)</sub> <sup>1</sup>	-1.5%	V <sub>OUT(E)</sub> <sup>2</sup>	1.5%	V	V <sub>IN</sub> =V <sub>OUT(T)</sub> +2V, I <sub>o</sub> =1mA
		-2.5%		2.5%		V <sub>IN</sub> =V <sub>OUT(T)</sub> +2V, I <sub>o</sub> =300mA
Output Current	I <sub>o</sub>	300	-	-	mA	V <sub>IN</sub> =V <sub>OUT(T)</sub> +2V, V <sub>OUT</sub> ≥ V <sub>OUT(E)</sub> *0.96
Current Limit	I <sub>LIM</sub>	300	450	-	mA	V <sub>IN</sub> =V <sub>OUT(T)</sub> +2V, V <sub>O</sub> >1.2V
Load Regulation	REG <sub>LOAD</sub>	-1	0.2	1	%	V <sub>IN</sub> =V <sub>OUT(T)</sub> +2V, I <sub>o</sub> =1mA to 300mA
Dropout Voltage	V <sub>DROPOUT</sub>	-	-	1300	mV	1.2V ≤ V <sub>OUT(T)</sub> ≤ 2.0V
		-	-	400		2.0V < V <sub>OUT(T)</sub> ≤ 2.8V
		-	-	300		2.8V < V <sub>OUT(T)</sub>
						I <sub>o</sub> =300mA V <sub>O</sub> =V <sub>OUT(E)</sub> -2%
Quiescent Current	I <sub>q</sub>	-	30	50	μA	V <sub>IN</sub> =V <sub>OUT(T)</sub> +1V, I <sub>o</sub> =0mA
Line Regulation	REG <sub>LINE</sub>	-0.2	-	0.2	%	1.2V ≤ V <sub>OUT(T)</sub> ≤ 1.4V
		-0.15	-	0.15		1.4V < V <sub>OUT(T)</sub> ≤ 2.0V
		-0.1	0.02	0.1		2.0V < V <sub>OUT(T)</sub> < 4.0V
		-0.4	0.2	0.4		4.0V < V <sub>OUT(T)</sub>
						I <sub>o</sub> =1mA V <sub>IN</sub> =V <sub>OUT(T)</sub> +1 to V <sub>OUT(T)</sub> +2
Input Voltage	V <sub>IN</sub>	Note <sup>3</sup>	-	7	V	
Over Temperature Shutdown	O <sub>TS</sub>	-	150	-	°C	
Over Temperature Hysteresis	O <sub>TH</sub>	-	30	-	°C	
Output Voltage Temperature Coefficient	T <sub>c</sub>	-	30	-	ppm/°C	
Short Circuit Current <sup>4</sup>	I <sub>SC</sub>	-	150	300	mA	V <sub>IN</sub> =V <sub>OUT(T)</sub> +1V, V <sub>OUT</sub> <0.8V
Power Supply Rejection	PSRR	-	60	-	dB	f=100Hz
		-	50	-		f=1kHz
		-	20	-		f=10kHz
						I <sub>o</sub> =100mA C <sub>O</sub> =2.2μF
Output Voltage Noise	e <sub>N</sub>	-	30	-	μV <sub>rms</sub>	C <sub>O</sub> =2.2μF f=10Hz~100kHz I <sub>o</sub> =10mA
Ground Pin Current	I <sub>GND</sub>	-	35	-	μA	V <sub>IN</sub> =V <sub>OUT(T)</sub> +2V, I <sub>o</sub> =1mA~300mA
EN Input Threshold	V <sub>EH</sub>	2	-	V <sub>IN</sub>	V	V <sub>IN</sub> =2.7V to 7V
	V <sub>EL</sub>	0	-	0.4		
EN Input Bias Current	I <sub>EH</sub>	-	-	0.1	μA	V <sub>EN</sub> =V <sub>IN</sub> , V <sub>IN</sub> =2.7V to 7V
	I <sub>EL</sub>	-	-	0.5		V <sub>EN</sub> =0V, V <sub>IN</sub> =2.7V to 7V
Shutdown Supply Current	I <sub>SD</sub>	-	0.5	1	μA	V <sub>IN</sub> =5V, V <sub>O</sub> =0V, V <sub>EN</sub> <V <sub>EL</sub>
Shutdown Output Voltage	V <sub>O,SD</sub>	0	-	0.4	V	I <sub>o</sub> =0.4mA, V <sub>EN</sub> <V <sub>EL</sub>

- Note 1:  $V_{OUT}(E)$  =Effective Output Voltage (i.e. the output voltage when " $V_{OUT}(T) + 2.0V$ " is provided at the VIN pin while maintaining a certain  $I_{OUT}$  value).  
 2:  $V_{OUT}(T)$  =Specified Output Voltage  
 3:  $V_{IN(MIN)} = V_{OUT} + V_{DROPOUT}$   
 4: To prevent the Short Circuit protection feature from being prematurely activated, the input voltage must be applied before a current source load is applied.

### Ordering Information(contd.)

Part Number	Marking	Output Voltage	Part Number	Marking	Output Voltage
SQ2163-15	3F152 XXXX	1.5V	SQ2163-18	3F182 XXXX	1.8V
SQ2163-20	3F202 XXXX	2.0V	SQ2163-25	3F252 XXXX	2.5V
SQ2163-27	3F272 XXXX	2.7V	SQ2163-2H	3F2H2 XXXX	2.85V
SQ2163-28	3F282 XXXX	2.8V	SQ2163-29	3F292 XXXX	2.9V
SQ2163-30	3F302 XXXX	3.0V	SQ2163-31	3F312 XXXX	3.1V
SQ2163-33	3F332 XXXX	3.3V	SQ2163-34	3F342 XXXX	3.4V
SQ2163-35	3F352 XXXX	3.5V	SQ2163-36	3F362 XXXX	3.6V
SQ2163-37	3F372 XXXX	3.7V	SQ2163-38	3F382 XXXX	3.8V
SQ2163-50	3F502 XXXX	5.0V			

### Characteristics Curve

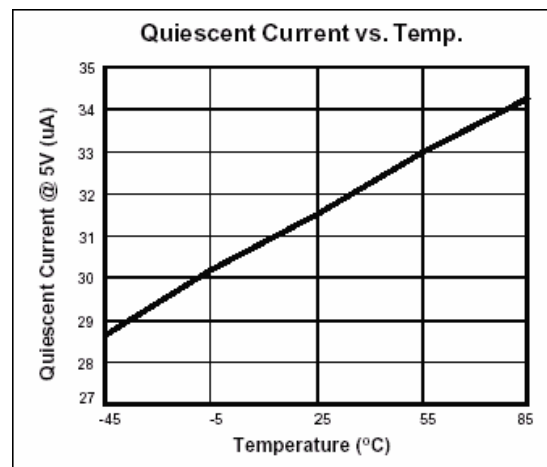
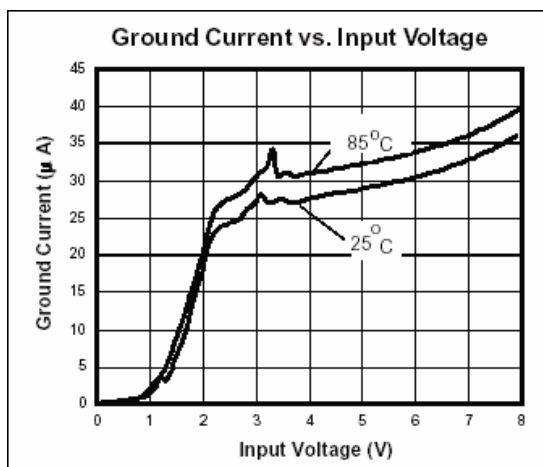

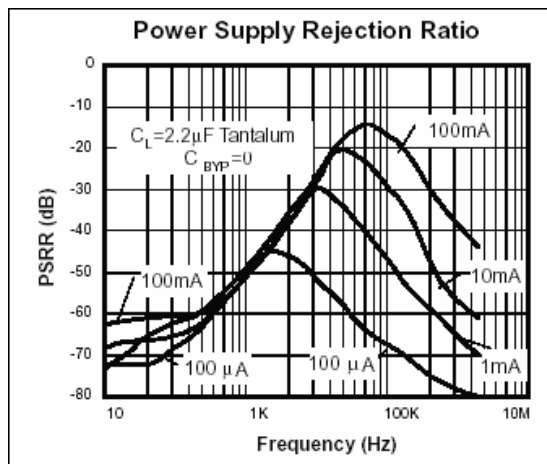
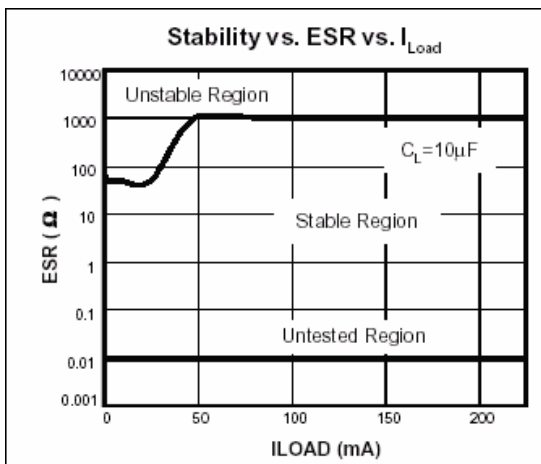
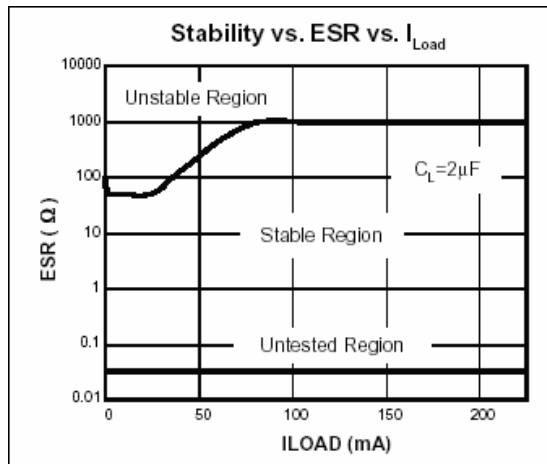
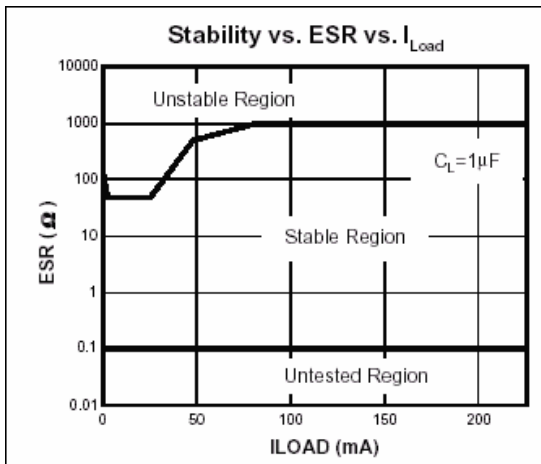
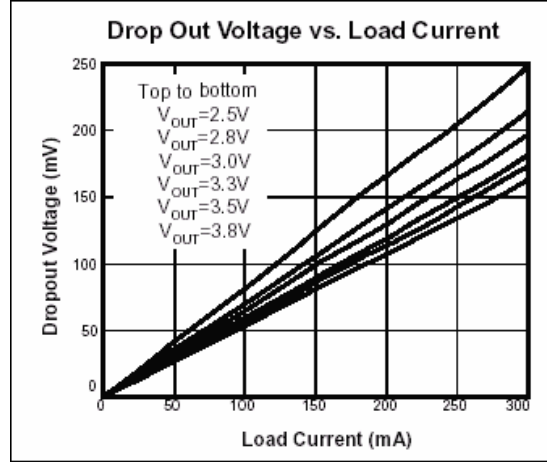
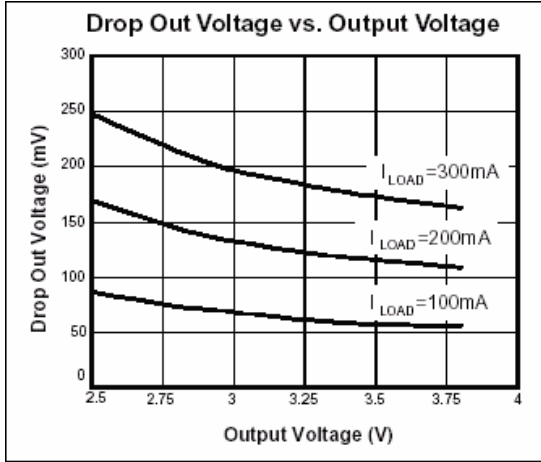

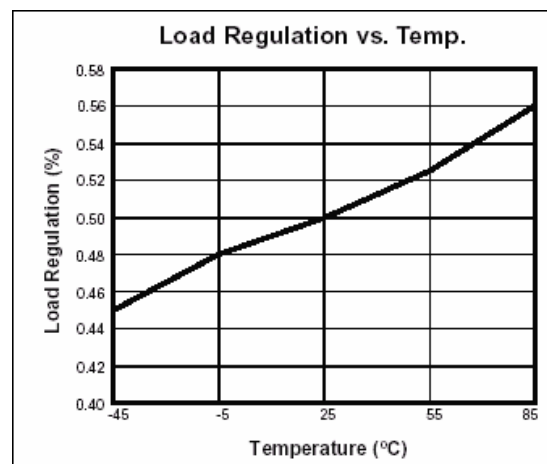
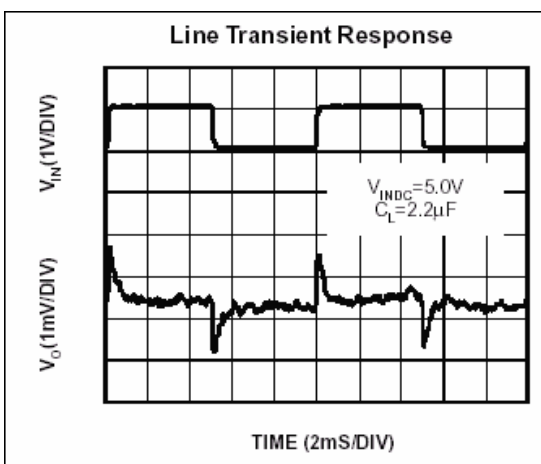
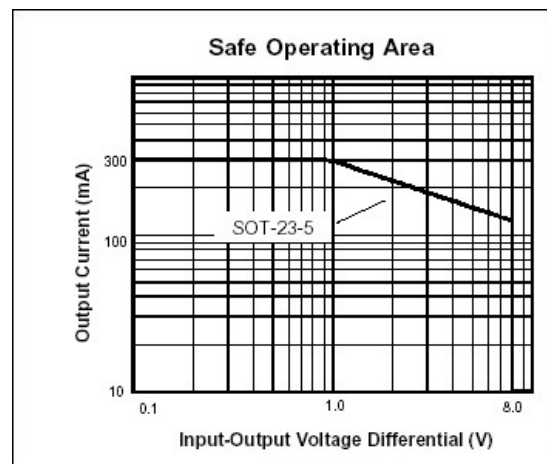
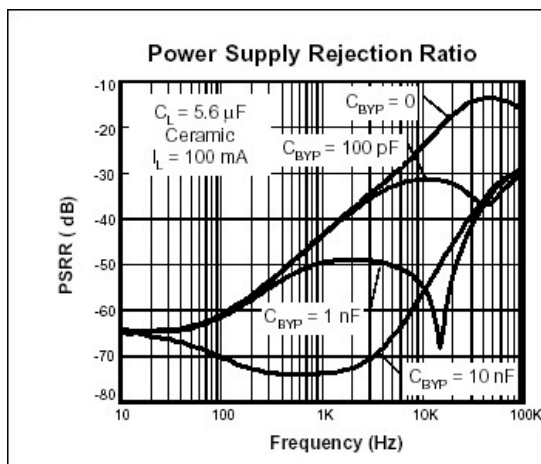
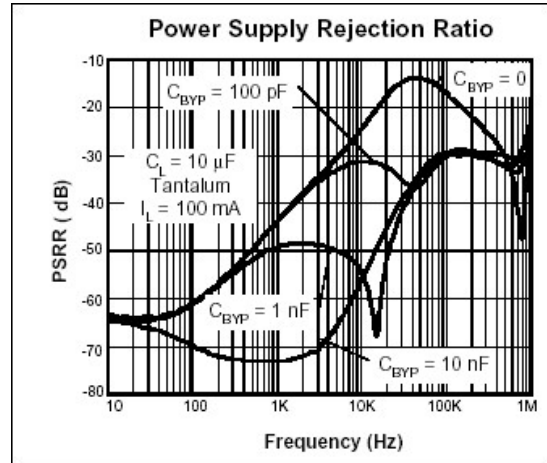
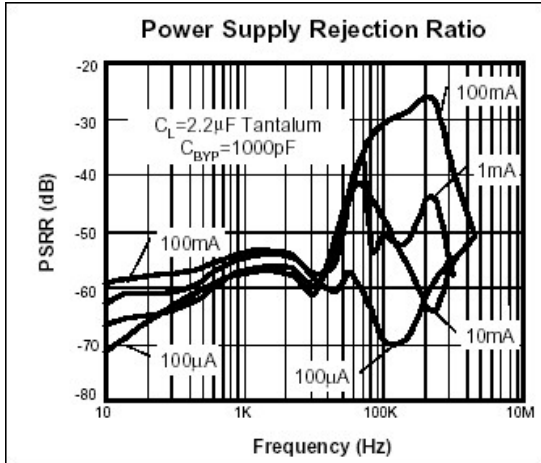

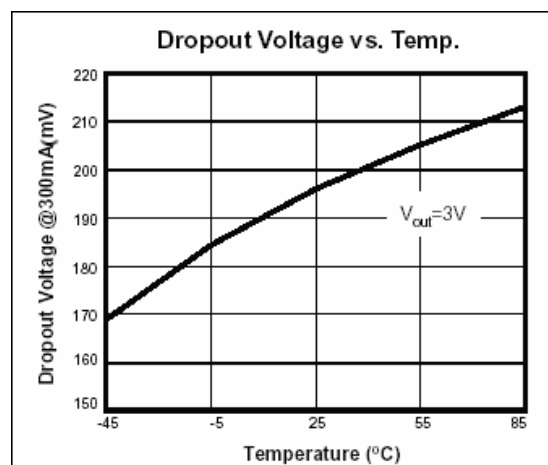
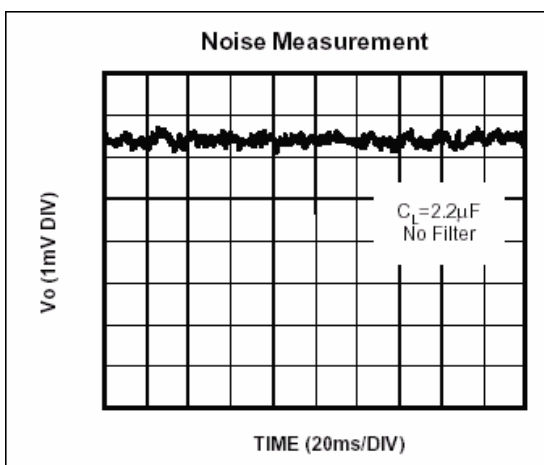
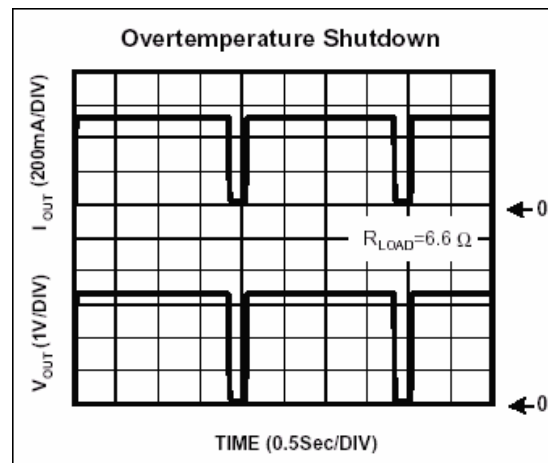
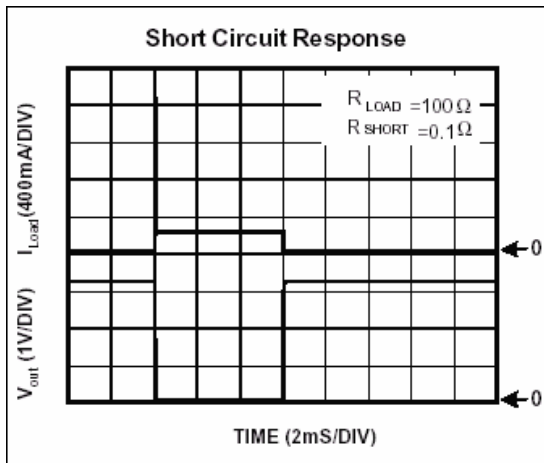
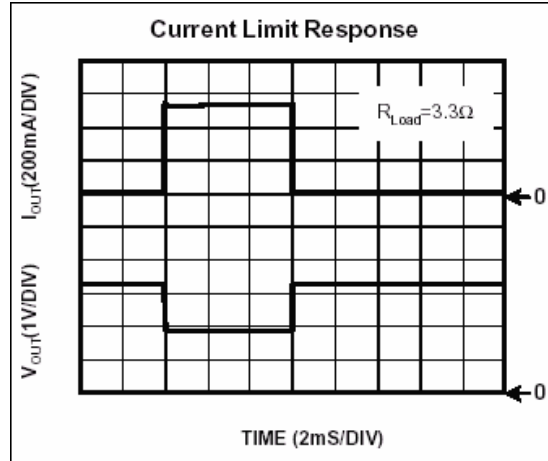
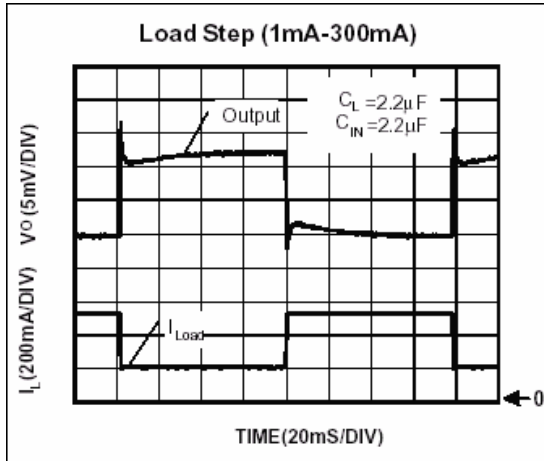

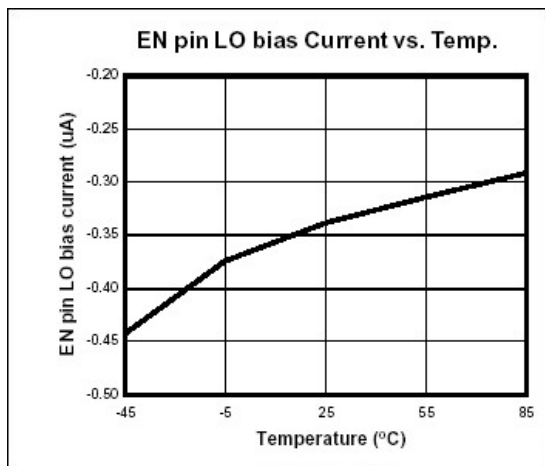
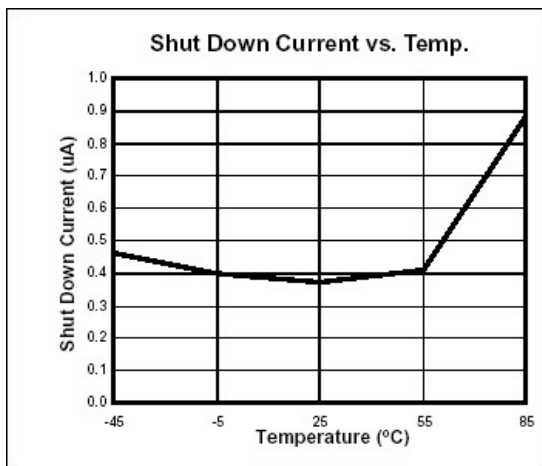
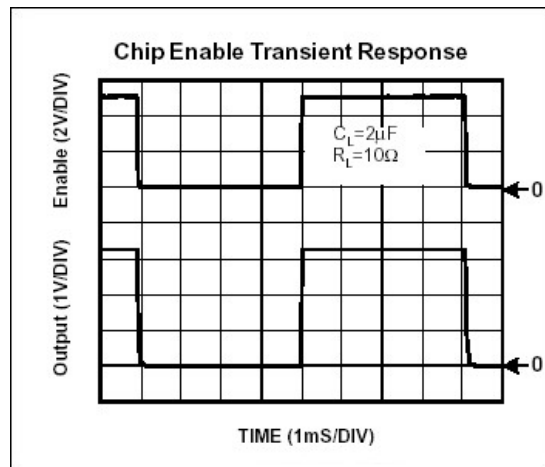
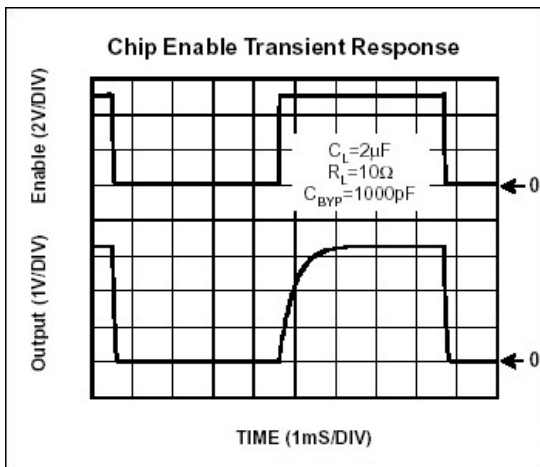

## Detailed Description

The SQ2163 series of CMOS regulators contain a PMOS pass transistor, voltage reference, error amplifier, over-current protection and thermal shutdown. The P-channel pass transistor receives data from the error amplifier, over-current shutdown, and thermal protection circuits. During normal operation, the error amplifier compares the output voltage to a precision reference. Over-current and Thermal shutdown circuits become active when the junction temperature exceeds 150°C, or the current exceeds 300mA. During thermal shutdown, the output voltage remains low. Normal operation is restored when the junction temperature drops below 120°C. The SQ2163 switches from voltage mode to current mode when the load exceeds the rated output current. This prevents over-stress. The SQ2163 also incorporates current fold-back to reduce power dissipation when the output is short circuited. This feature becomes active when the output drops below 0.8 volts, and reduces the current flow by 65%. Full current is restored when the voltage exceeds 0.8 volts.

## External Capacitors

The SQ2163 is stable with an output capacitance to ground of 2.2µF or greater. Ceramic capacitors have the lowest ESR, and will offer the best AC performance. Conversely, Aluminum Electrolytic capacitors exhibit the highest ESR, resulting in the poorest AC response. Unfortunately, large value ceramic capacitors are comparatively expensive. One option is to parallel a 0.1 µF ceramic capacitor with a 10 µF Aluminum Electrolytic. The benefit is low ESR, high capacitance, and low overall cost. A second capacitor is recommended between the input and ground to stabilize  $V_{in}$ . The input capacitor should be at least 0.1µF to have a beneficial effect. A third capacitor can be connected between the BY-PASS pin and GND. this capacitor can be a low cost Polyester Film variety between the value of 0.001 ~0.01 µF. A large capacitor improves the AC ripple rejection, but also makes the output come up slowly. This "Soft" turn-on is desirable in some applications to limit turn-on surges. All capacitors should be placed in close proximity to the pins. A "Quiet" ground termination is desirable. This can be achieved with a "Star" connection.

## Enable

The Enable pin normally floats high. When actively, pulled low, the PMOS pass transistor shuts off, and all internal circuits are powered down. In this state, the quiescent current is less than 1µA. This pin behaves much like an electronic switch.