

300W FLIP CHIP TVS ARRAY

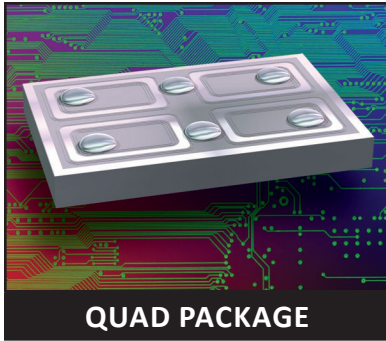

QUAD PACKAGE

DESCRIPTION

The SFC05-4 is a 5 Volt, flip chip transient voltage suppressor (TVS) array designed to provide protection for power bus, data, control or I/O lines. Rated at 300 Watts peak pulse power for an 8/20 μ s waveshape, this device protects 4 unidirectional lines.

This device is a type of chip scale package (CSP) that can be mounted onto a printed circuit board or in a connector requiring a limited amount of space and is compatible with "pick and place" equipment for automatic assembly. The SFC05-4 is compatible with IEC 61000-4-2 (ESD), 61000-4-4(EFT) and 61000-4-5(Surge) requirements.

FEATURES

- Compatible with IEC 61000-4-2 (ESD): Air 15kV, Contact 8kV
- Compatible with IEC 61000-4-4 (EFT): 40A, 5/50ns
- Compatible with IEC 61000-4-5 (Surge): 24A, 8/20 μ s - Level 2(Line - Gnd) & Level 3 (Line - Line)
- ESD Protection > 25 kilovolts
- 300 Watts Peak Pulse Power per Line ($t_p = 8/20\mu$ s)
- Protects up to 4 Unidirectional Lines
- RoHS Compliant
- REACH Compliant

APPLICATIONS

- Cellular Phones
- SMART Phones
- PCMCIA Cards
- Ground Positioning System (GPS)

MECHANICAL CHARACTERISTICS

- Quad Flip Chip Package
- Approximate Weight: 0.73 milligrams
- Lead-Free Plating
- Solder Reflow Temperature:
 - Lead-Free - Sn/Ag/Cu, 96/3.5/0.5: 260-270°C
- Flammability Rating UL 94V-0
- 8mm Tape per EIA Standard 481
- Top Contacts: Solder Bump 0.004" in Height (Nominal)

PIN CONFIGURATION

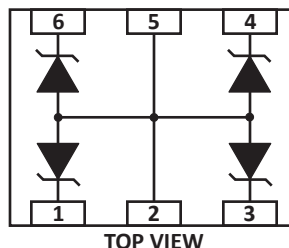

TYPICAL DEVICE CHARACTERISTICS
MAXIMUM RATINGS @ 25°C Unless Otherwise Specified

PARAMETER	SYMBOL	VALUE	UNITS
Peak Pulse Power (tp = 8/20μs) - See Figure 1	P_{PP}	300	Watts
Operating Temperature	T_A	-55 to 150	°C
Storage Temperature	T_{STG}	-55 to 150	°C

ELECTRICAL CHARACTERISTICS PER LINE @ 25°C Unless Otherwise Specified

PART NUMBER	RATED STAND-OFF VOLTAGE V_{WM} VOLTS	MINIMUM BREAKDOWN VOLTAGE @ 1mA $V_{(BR)}$ VOLTS	MAXIMUM CLAMPING VOLTAGE (Fig. 2) @ $I_p = 5A$ V_c VOLTS	MAXIMUM CLAMPING VOLTAGE (Fig. 2) @ 8/20μS $V_c @ I_{PP}$	MAXIMUM LEAKAGE CURRENT @ V_{WM} I_D μA	TYPICAL CAPACITANCE @ 0V, 1MHz C_j pF
SFC05-4	5.0	6.0	9.5	11.0V @ 24.0A	10	150

TYPICAL DEVICE CHARACTERISTICS

FIGURE 1
PEAK PULSE POWER VS PULSE TIME

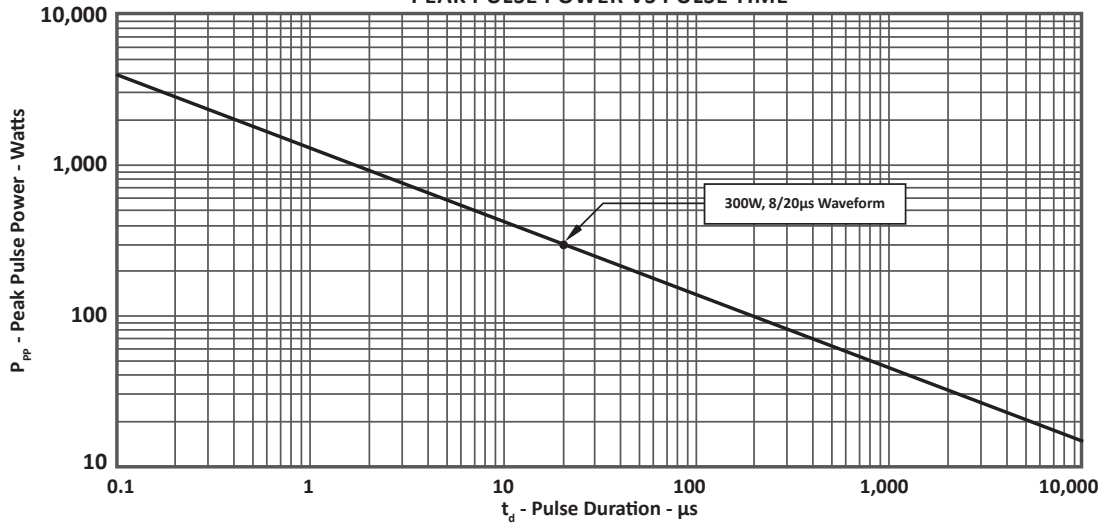

FIGURE 2
PULSE WAVE FORM

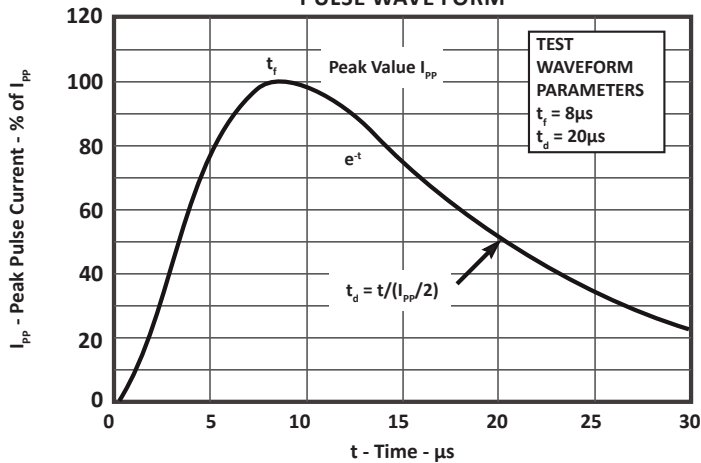
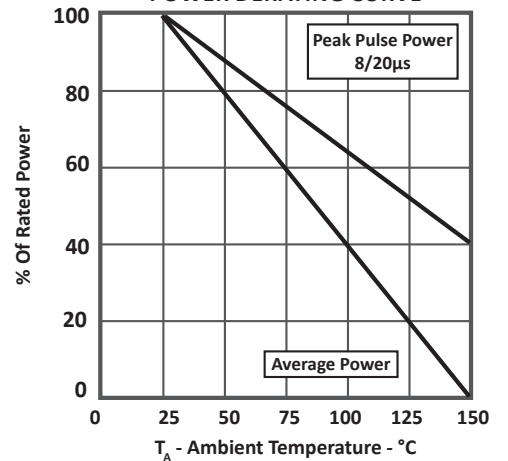

FIGURE 3
POWER DERATING CURVE



TYPICAL DEVICE CHARACTERISTICS

FIGURE 4
OVERSHOOT & CLAMPING VOLTAGE

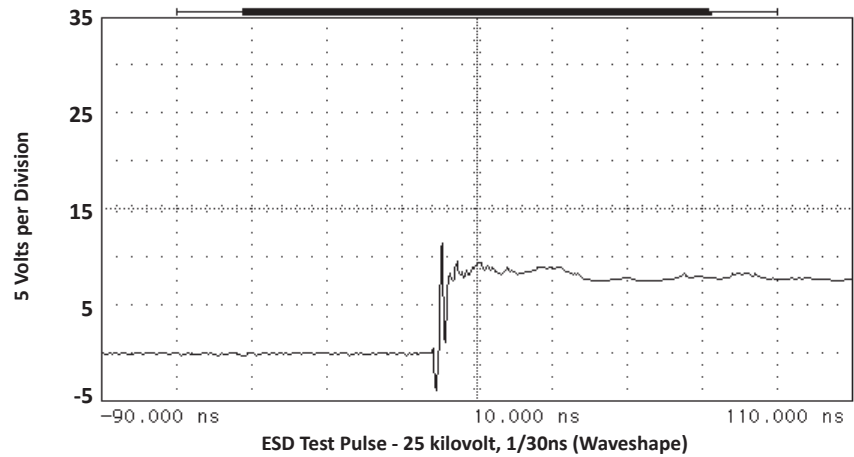
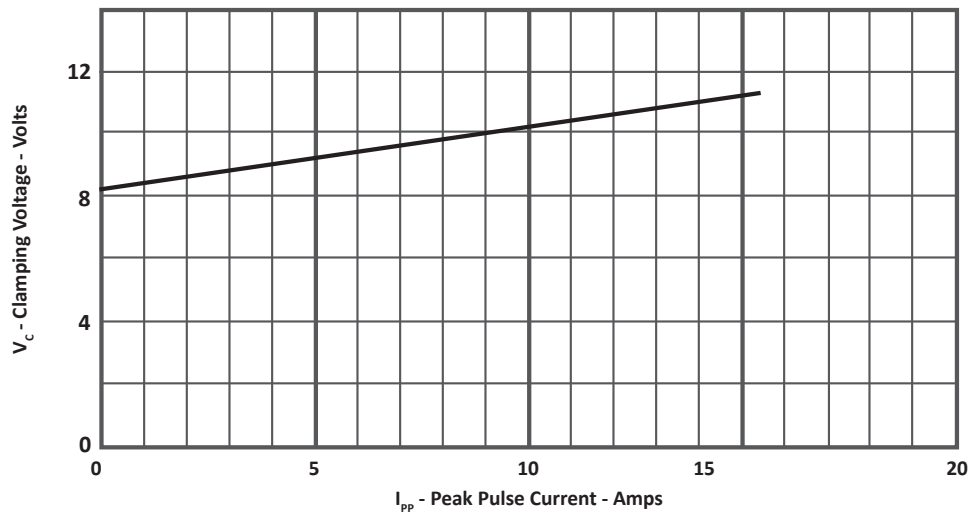

FIGURE 5
TYPICAL CLAMPING VOLTAGE VS PEAK PULSE CURRENT



SPICE MODEL

FIGURE 1
SPICE MODEL FOR



ABD - Avalanche Breakdown Diode (TVS)

TABLE 1 - SPICE PARAMETERS		
PARAMETER	UNIT	ABD(TVS)
BV	V	6
IBV	μA	1
C_{jo}	pF	20
I_s	A	1E-12
Vj	V	-
M	-	0.33
N	-	1
R_s	Ohms	0.28
TT	s	1E-8
EG	eV	1.11

SOLDER REFLOW INFORMATION

PRINTED CIRCUIT BOARD RECOMMENDATIONS	
PARAMETER	VALUE
Pad Size on PCB	0.275mm
Pad Shape	Round
Pad Definition	Non-Solder Mask Defined Pads
Solder Mask Opening	0.325mm Round
Solder Stencil Thickness	0.150mm
Solder Stencil Aperture Opening (Laser cut, 5% tapered walls)	0.330mm Round
Solder Paste Type	No Clean
Pad Protective Finish	OSP (Entek Cu Plus 106A)
Tolerance - Edge To Corner Ball	±50µm
Solder Ball Side Coplanarity	±20µm
Maximum Dwell Time Above Liquidous (183°C)	60 seconds
Soldering Maximum Temperature	270°C

REQUIREMENTS

Temperature:

T_p for Lead-Free (Sn/Ag/Cu): 260-270°C

T_p for Tin-Lead: 240-245°C

Preheat time and temperature depends on solder paste and flux activation temperature, component size, weight, surface area and plating.

RECOMMENDED NON-SOLDER MASK DEFINED PAD ILLUSTRATION

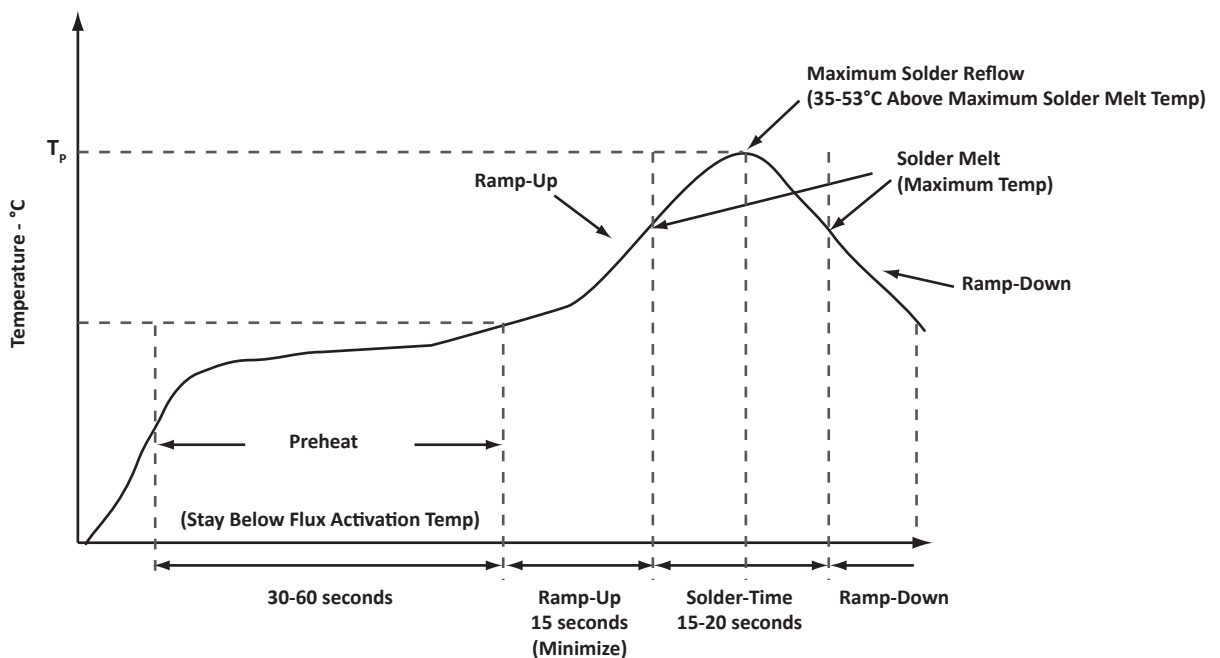
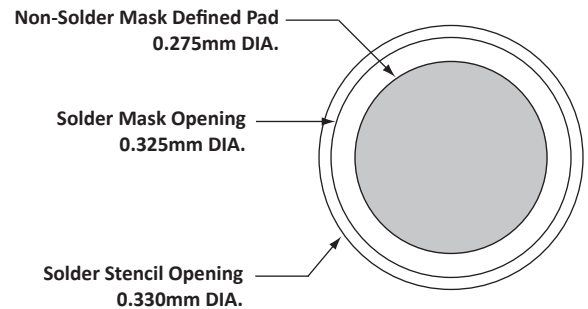

QUAD PACKAGE INFORMATION

OUTLINE DIMENSIONS				
DIM	MILLIMETERS		INCHES	
	MIN	MAX	MIN	MAX
A	0.510		0.020	
B	0.510		0.020	
C	0.98	1.02	0.038	0.040
E	0.15 SQ		0.006 SQ	
F	1.47	1.53	0.058	0.060
G	0.15		0.006	
H	0.076	0.10	0.003	0.004
I	0.419		0.0165	

NOTES

- Controlling dimensions in inches.
- Decimal tolerance: .xxx ± 0.05mm (0.002").

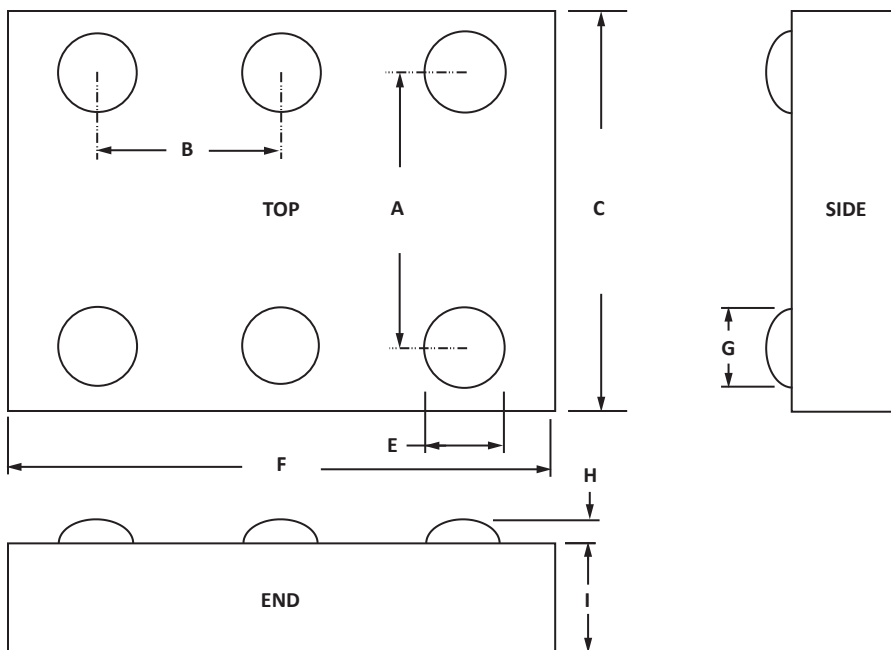

QUAD PACKAGE INFORMATION
OPTION 1 - LAYOUT DIMENSIONS

DIM	MILLIMETERS		INCHES	
	MIN	MAX	MIN	MAX
A	0.305		0.012	
B	0.457		0.018	
C	0.203		0.008	
D	0.254		0.010	
E	0.510		0.020	
F	0.990		0.039	
G	0.510		0.020	

NOTES

1. Controlling dimensions in inches.
2. Decimal tolerance: .xxx ± 0.05mm (0.002").
3. Preferred: Using 0.1mm (0.004") stencil.

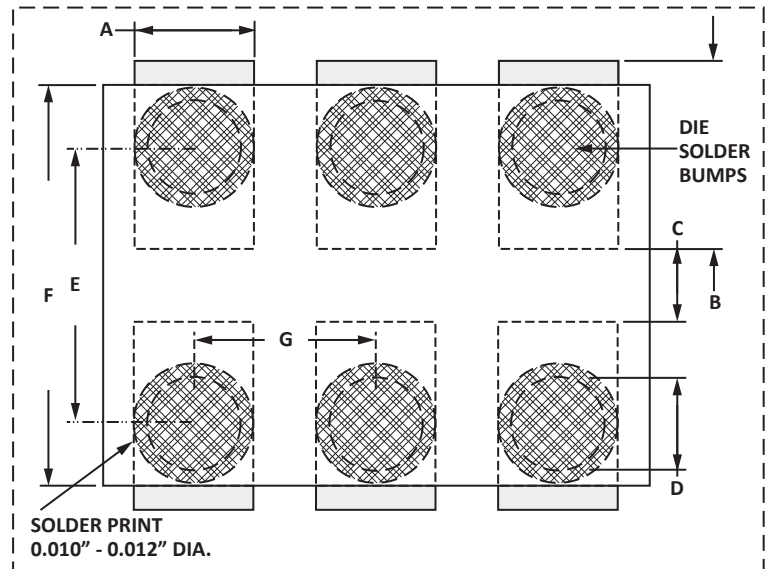

OPTION 2 - LAYOUT DIMENSIONS

DIM	MILLIMETERS		INCHES	
	MIN	MAX	MIN	MAX
A	0.51		0.020	
F	0.15 SQ		0.006 SQ	
G	0.71		0.028	
H	0.99		0.039	
I	0.51		0.020	

NOTES

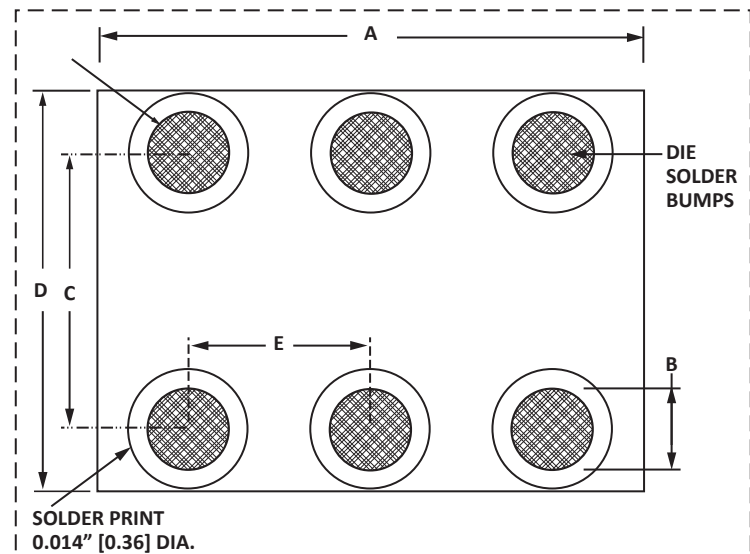
1. Controlling dimensions in inches.
2. Decimal tolerance: .xxx ± 0.05mm (0.002").
3. Preferred: Using 0.1mm (0.004") stencil.

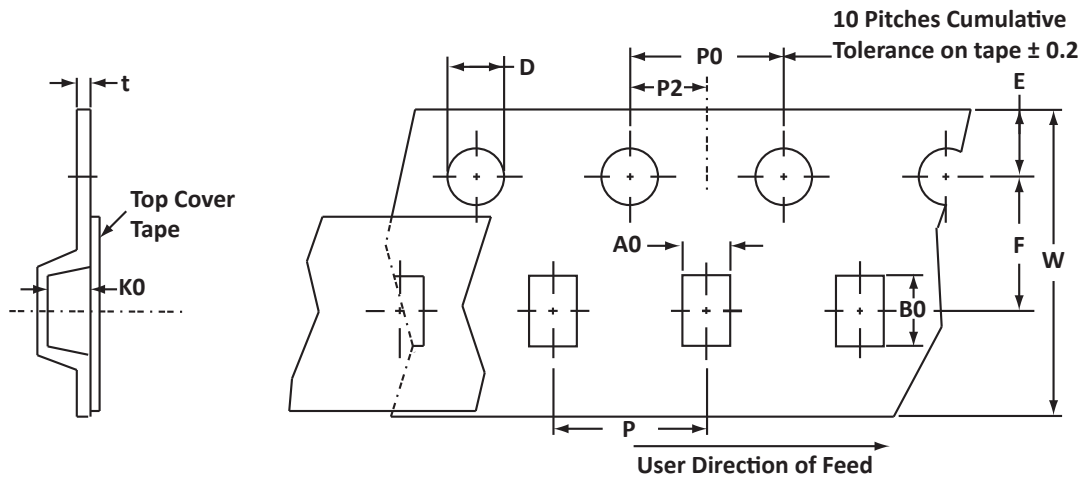

TAPE AND REEL INFORMATION

SPECIFICATIONS

REEL DIA.	TAPE WIDTH	A0	B0	K0	D	E	F	W	P0	P2	P	tmax
178(7")	8	0.80 ± 0.10	1.20 ± 0.10	0.70 ± 0.10	1.50 ± 0.10	1.75 ± 0.10	3.50 ± 0.05	8.00 ± 0.30	4.00 ± 0.12	2.00 ± 0.10	2.00 ± 0.10	0.25

NOTES

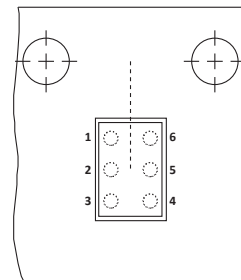
1. Dimensions in millimeters.
2. Top view of tape. Solder bumps are face down in tape package.
3. Orientation: preferred stencil - 0.1mm (0.004").
4. Surface mount product is taped and reeled in accordance with EIA 481.
5. 8mm plastic tape: 7" Reels - 5,000 pieces per reel.
6. Marking on Reel - part number, date code and lot number.

TAPE & REEL ORIENTATION

Package outline, pad layout and tape specifications per document number 06039.R2 9/09.

ORDERING INFORMATION

BASE PART NUMBER	LEADFREE SUFFIX	TAPE SUFFIX	QTY/REEL	REEL SIZE	TUBE QTY
SFC05-4	-LF	-T75-1	5,000	7"	n/a

This device is only available in a Lead-Free configuration.

COMPANY INFORMATION

COMPANY PROFILE

In business more than 20 years, ProTek Devices™ is a privately-held company located in Tempe, Arizona, that offers a product line of transient voltage suppressors (TVS); avalanche breakdown diodes; steering diode TVS arrays and other surge suppressor component products. These TVS devices protect electronic systems from the effects of lightning, electrostatic discharge (ESD), nuclear electromagnetic pulses (NEMP), inductive switching and EMI / RFI. ProTek Devices also offers high performance interface and linear products that include analog switches; multiplexers; LED drivers; audio control ICs; RF and related high frequency products. The analog devices work in a host of consumer; industrial; automotive and other applications.

CONTACT US

Corporate Headquarters

2929 South Fair Lane
Tempe, Arizona 85282
USA

By Telephone

General: 602-431-8101
Sales: & Marketing: 602-414-5109
Customer Service: 602-414-5114
Product Technical Support: 602-414-5107

By Fax

General: 602-431-2288

By E-mail:

Sales: sales@protekdevices.com
Customer Service: service@protekdevices.com
Technical Support: support@protekdevices.com

ProTek Devices (Asia Pacific) Pte. Ltd.

8 Ubi Road 2, #06-19
Zervex
Singapore - 408538
Tel: +65-67488312
Fax: +65-67488313

Web

www.protekdevices.com

COPYRIGHT © ProTek Devices 2007 - This literature is subject to all applicable copyright laws and is not for resale in any manner.

SPECIFICATIONS: ProTek reserves the right to change the electrical and or mechanical characteristics described herein without notice.

DESIGN CHANGES: ProTek reserves the right to discontinue product lines without notice and that the final judgement concerning selection and specifications is the buyer's and that in furnishing engineering and technical assistance. ProTek assumes no responsibility with respect to the selection or specifications of such products. ProTek makes no warranty, representation or guarantee regarding the suitability of its products for any particular purpose, nor does ProTek assume any liability arising out of the application or use of any product or circuit and specifically disclaims any and all liability without limitation special, consequential or incidental damages.

LIFE SUPPORT POLICY: ProTek Devices products are not authorized for use in life support systems without written consent from the factory.

PATENT INFORMATION: This device is patented under U.S. Patent No. Des. "D456,367S".