

# SPECIFICATION FOR LCD MODULE

Model No. TM13265ECBWUG

<b>Prepared by:</b>	<b>Date:</b>
<b>Checked by :</b>	<b>Date:</b>
<b>Verified by :</b>	<b>Date:</b>
<b>Approved by:</b>	<b>Date:</b>

**TIANMA MICROELECTRONICS CO., LTD**

**REVISION RECORD**

<b>Date</b>	<b>Ref. Page</b>	<b>Revision No.</b>	<b>Revision Items</b>	<b>Check &amp; Approval</b>

## 1 General Specifications:

1.1 Display type: FSTN

1.2 Display color\*<sup>1</sup>:

Display color: Blue-Black

Background\*<sup>2</sup>: White

1.3 Polarizer mode: Transflective/Positive

1.4 Viewing Angle: 12:00

1.5 Driving Method: 1/65 Duty 1/9 Bias

1.6 Logic Voltage: 3.0V

LCD Operating Voltage: 9.0V

1.7 Backlight: EL

1.8 Controller: NT7502H-BDT

1.9 Data Transfer: Serial

1.10 Operating Temperature: -20----+70°C

Storage Temperature: -30----+80°C

1.11 Outline Dimensions: Refer to outline drawing on next page

1.12 Weight: Approx. 15g

\*<sup>1</sup> Color tone is slightly changed by temperature and driving voltage.

\*<sup>2</sup> Color tone will be changed by backlight.

# 2 Outline Drawing

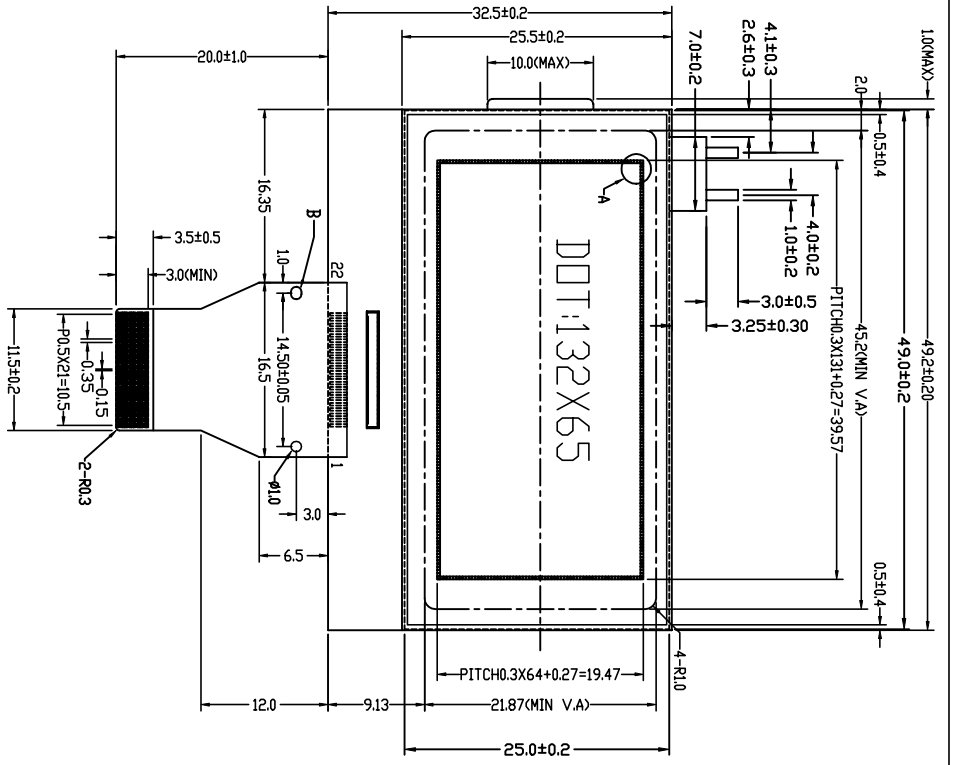

- NOTES:
1. DISPLAY TYPE: FSTN
  2. VIEWING DIRECTION: 12:00
  3. POLARIZER MODE: TRANSPARENT/POSITIVE
  4. DRIVE METHOD: 1/65 DUTY 1/9 BIAS
  5. LCD OPERATING VOLTAGE: 9.0V
  6. OPERATING TEMP: -20°C-+70°C
  7. STORAGE TEMP: -30°C-+80°C
  8. CONTROLLER: NT7502H-BDT
  9. VDD=3.0V
  10. CONNECTOR: FPC
  11. BACKLIGHT: EL
  12. UNMARKED TOLERANCES: ±0.3mm

NO.	PIN	NO.	PIN	NO.	PIN
1	NC	11	CAP3+	21	NC
2	NC	12	CAP1-	22	NC
3	CSI	13	CAP1+		
4	RES	14	CAP2+		
5	A0	15	CAP2-		
6	DR(SCL)	16	V1		
7	DR(SD)	17	V2		
8	VDD	18	V3		
9	VSS	19	V4		
10	VDDT	20	V0		

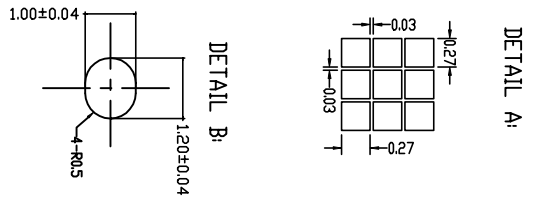
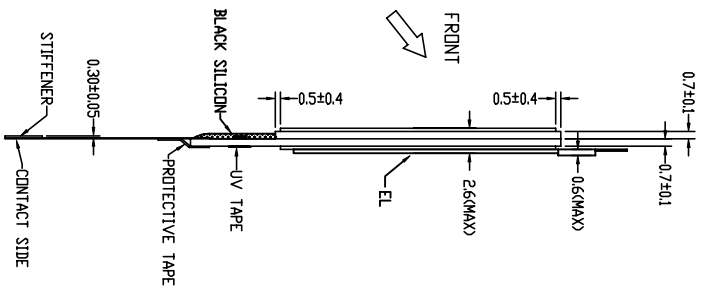



**TIAN-MA MICROELECTRONICS CO.**

6/F., CASTIC Building, Shennan Road, Central, Shenzhen, China

DRAWN BY:	TTITLE: TM13265ECBWUG	SCALE:	1:1
CHECKED BY:	DWG NO: G-4	DATE:	mm
APPROVED BY:	DWG NAME: TM13265ECBWUG-4	SHEET NO:	OF
CONFIRMED BY:			

### 3 LCD Module Part Numbering System

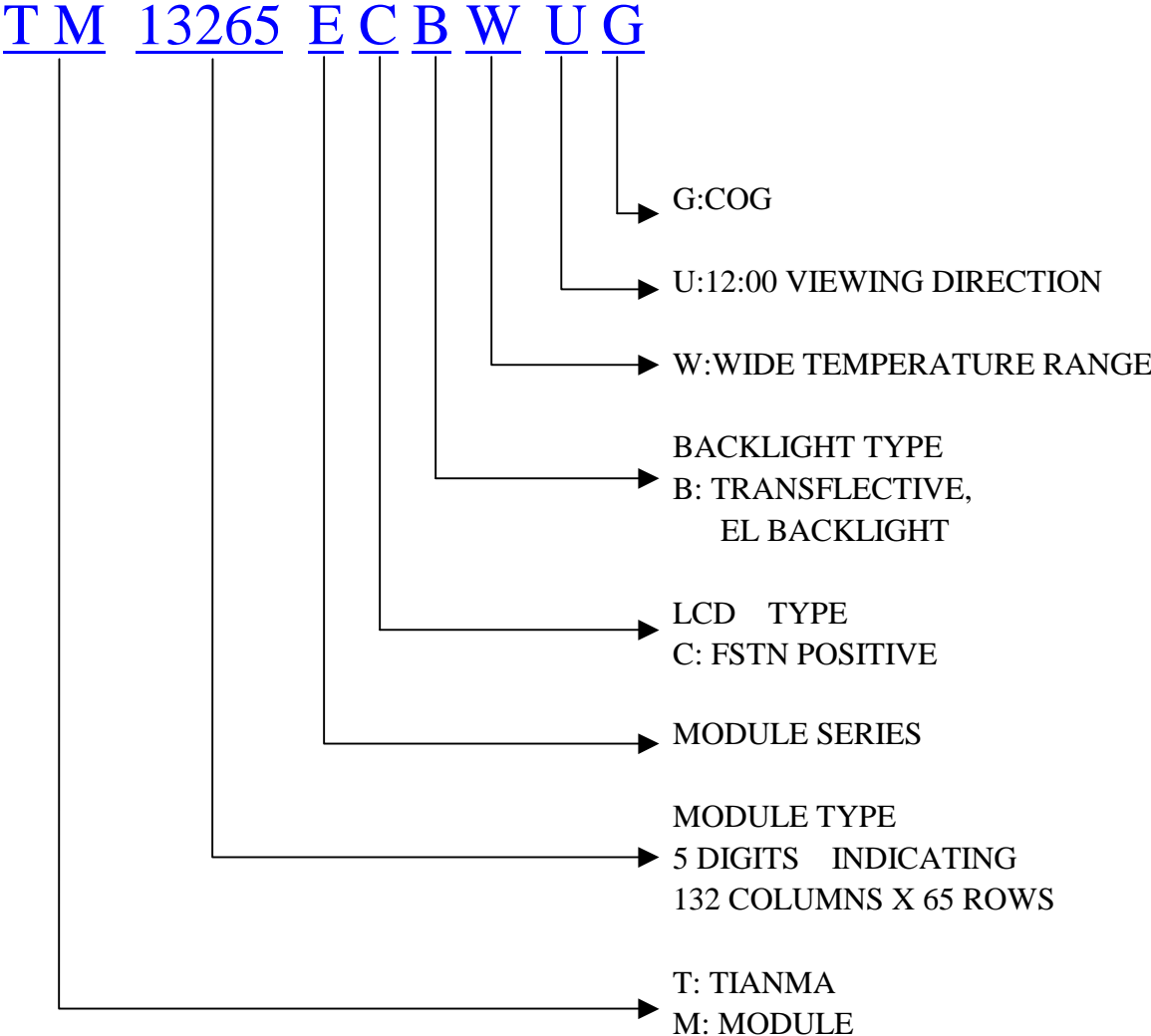

# 4 Circuit Block Diagram

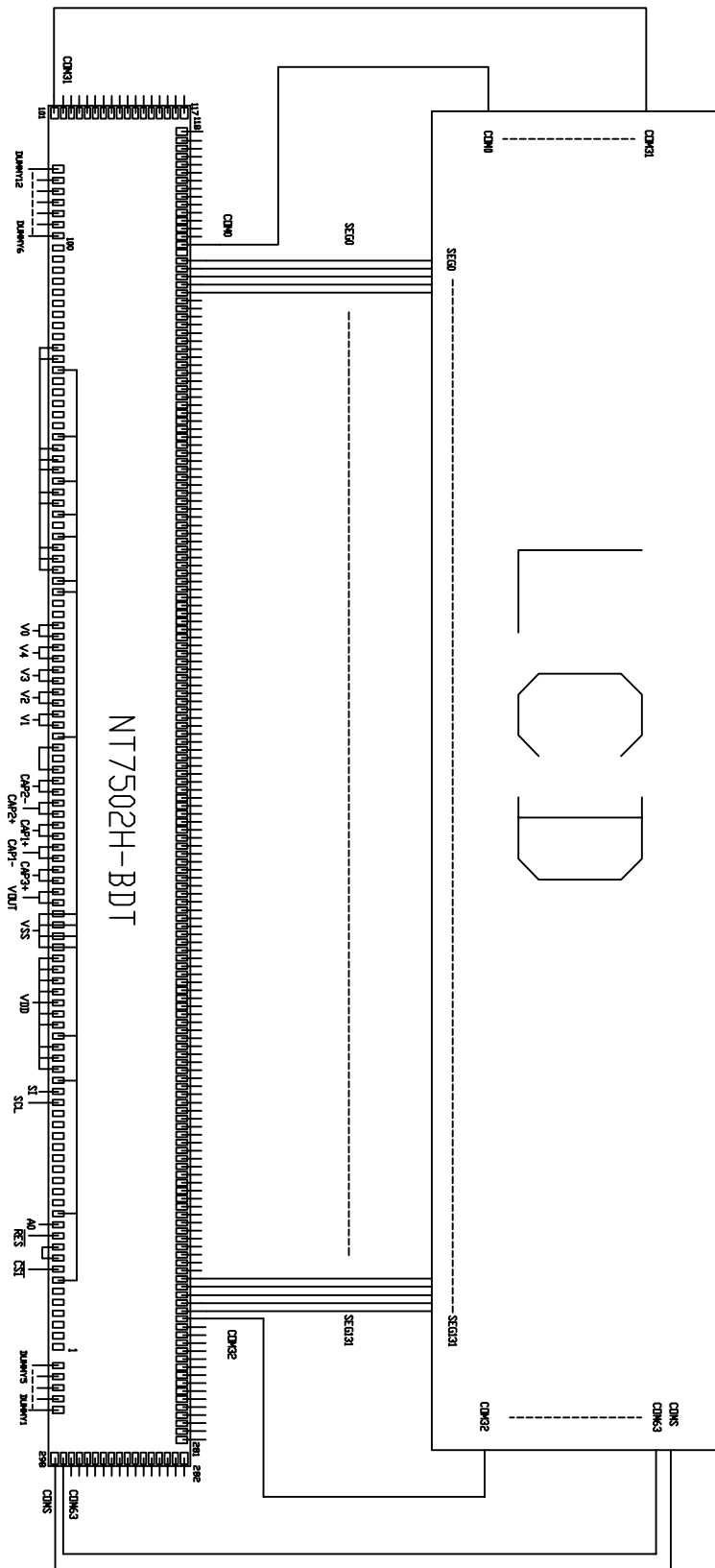

## 5 Absolute Maximum Ratings

Item	Symbol	Min.	Max.	Unit	Remark
Power Supply Voltage	$V_{DD}-V_{SS}$	-0.3	3.5	V	
LCD Driving Voltage	$V_{LCD}$	-	25.0		
Operating Temperature Range	$T_{OP}$	-20	+70	°C	No Condensation
Storage Temperature Range	$T_{ST}$	-30	+80		

## 6 Electrical Specifications and Instruction Code

### 6.1 Electrical characteristics

Item	Symbol	Min.	Typ.	Max.	Unit	
Supply Voltage (Logic)	$V_{DD}-V_{SS}$	2.4	3.0	3.5	V	
Supply Voltage (LCD Drive)	$V_{LCD}$	-	9.0	-	V	
Input Signal Voltage	High	$V_{IH}$ ( $V_{DD}=3.0V$ )	$0.8V_{DD}$	-	$V_{DD}+0.3$	V
	Low	$V_{IL}$ ( $V_{DD}=3.0V$ )	0	-	$0.2 V_{DD}$	V
Supply current (Logic)	$I_{DD}$ ( $V_{DD}-V_{SS}=3.0V$ )	-	-	500.0	uA	



## 6.2 Interface Signals

Pin No.	Symbol	Level	Description
1	NC	-	Not Connect
2	NC	-	Not Connect
3	$\overline{CS1}$	H/L	Chip selects signal. L:Active
4	$\overline{RES}$	H/L	Reset Signal
5	A0	H/L	H:D0-D7 are display data L:D0-D7 are control data
6	D6(SCL)	H/L	Data bit 6 serves as the serial clock input terminal
7	D7(SI)	H/L	Data bit 7 serves as the serial data input terminal
8	VDD	3.0V	Power supply voltage for logic and step-up voltage
9	VSS	0V	Ground
10	VOUT	-	DC/DC voltage converter output
11	CAP3+	-	Capacitor pin for voltage converter
12	CAP1-	-	Capacitor pin for voltage converter
13	CAP1+	-	Capacitor pin for voltage converter
14	CAP2+	-	Capacitor pin for voltage converter
15	CAP2-	-	Capacitor pin for voltage converter
16	V1	-	Power supply voltage for LCD
17	V2	-	Power supply voltage for LCD
18	V3	-	Power supply voltage for LCD
19	V4	-	Power supply voltage for LCD
20	V0	-	Power supply voltage for LCD
21	NC	-	Not Connect
22	NC	-	Not Connect

## 6.3 Interface Timing Chart

### Serial interface

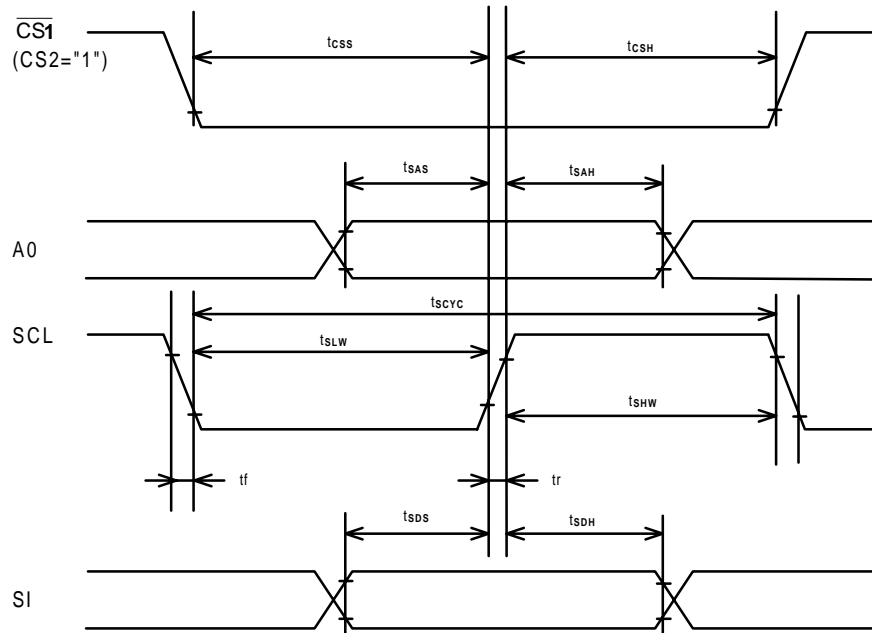

( $V_{DD}=2.7 - 3.3V$ ,  $T_A = -40 - 85^\circ C$ )

Symbol	Parameter	Min.	Typ.	Max.	Unit	Condition
TSCYC	Serial clock cycle	250			nS	
TSHW	Serial clock H pulse width	100			nS	
TSLW	Serial clock L pulse width	100			nS	
TSAS	Address setup time	150			nS	
TAH	Address hold time	150			nS	
TSDS	Data setup time	100			nS	
TDH	Data hold time	100			nS	
TCSS	$\overline{CS}$ serial clock time	150			nS	
TCSH	$\overline{CS}$ serial clock time	150			nS	

## 6.4 Instruction Code:

Command	Code											Function
	A0	$\overline{RD}$	$\overline{WR}$	D7	D6	D5	D4	D3	D2	D1	D0	
(1) Display ON/OFF	0	1	0	1	0	1	0	1	1	1	D	Turns on LCD panel when goes high, and turns off when goes low
(2) Set Display Start Line	0	1	0	0	1	Display start address					Specifies RAM display line for COM0	
(3) Set Page Address	0	1	0	1	0	1	1	Page address				Sets the display RAM page in Page Address register
(4) Set Column Address 4 higher bits	0	1	0	0	0	0	1	Higher column address				Sets 4 higher bits of column address of display RAM in register
(4) Set column Address 4 lower bits	0	1	0	0	0	0	0	Lower column address				Sets 4 lower bits of column address of display RAM in register
(5) Read Status	0	0	1	Status				0	0	0	0	Reads the status information
(6) Write Display Data	1	1	0	Write data							Writes data in display RAM	
(7) Read Display Data	1	0	1	Read data							Reads data from display RAM	
(8) ADC select	0	1	0	1	0	1	0	0	0	0	D	Sets the display RAM address SEG output correspondence
(9) Normal/Reverse Display	0	1	0	1	0	1	0	0	1	1	D	Normal indication when low, but full indication when high
(10) Entire Display ON/OFF	0	1	0	1	0	1	0	0	1	0	0 1	Selects normal display (0) or Entire Display ON (1)
(11) Set LCD Bias	0	1	0	1	0	1	0	0	0	1	D	Sets LCD drive voltage bias ratio
(12) Read-Modify-Write	0	1	0	1	1	1	0	0	0	0	0	Increments Column Address counter during each write
(13) End	0	1	0	1	1	1	0	1	1	1	0	Releases the Read-Modify-Write
(14) Reset	0	1	0	1	1	1	0	0	0	1	0	Resets internal functions
(15) Common output mode select	0	1	0	1	1	0	0	D	*	*	*	Selects COM output scan direction. * Invalid data
(16) Set Power Control	0	1	0	0	0	1	0	1	Operation status		Selects the power circuit operation mode	
(17) V0 voltage regulator internal resistor ratio set	0	1	0	0	0	1	0	0	Resistor ratio		Select internal resistor ratio (Rb / Ra) mode	
(18) Electronic volume mode set	0	1	0	1	0	0	0	0	0	0	1	Set the V0 output voltage electronic volume register
Electronic Volume Register set	0	1	0	*	*	Electronic control value						
(19) Set static indicator On/Off	0	1	0	1	0	1	0	1	1	0	D	Set static indicator On/Off 0: OFF 1: ON
Set Static indicator register	0	1	0	*	*	*	*	*	*	Mode		Set the flashing mode
(20) Power Save	-	-	-	-	-	-	-	-	-	-	-	Compound command of display OFF and entire display ON
(21) NOP	0	1	0	1	1	1	0	0	0	1	1	Command for non-operation
(22) Test Command	0	1	0	1	1	1	1	*	*	*	*	IC Test command. Do not use!
(23) Test Mode Reset	0	1	0	1	1	1	1	0	0	0	0	Command of test mode reset

Note: Do not use any other command, or the system malfunction may result.

## 7 Optical Characteristics

### 7.1 Optical Characteristics

Ta=25°C

Item	Symbol	Condition	Min.	Typ.	Max.	Unit	
Viewing Angle	$\theta_x$	$C_r \geq 2$	$\theta_y = 0^\circ$	-20	--	30	Deg
	$\theta_y$						
Contrast Ratio	$C_r$	$\theta_x = 0^\circ$ $\theta_y = 0^\circ$	3.0	-	-		
Response Time	Turn on	$T_{on}$	$\theta_x = 0^\circ$ $\theta_y = 0^\circ$	-	-	300	ms
	Turn off	$T_{off}$				-	

## 7.2 Definition of Optical Characteristics

### 7.2.1 Definition of Viewing Angle

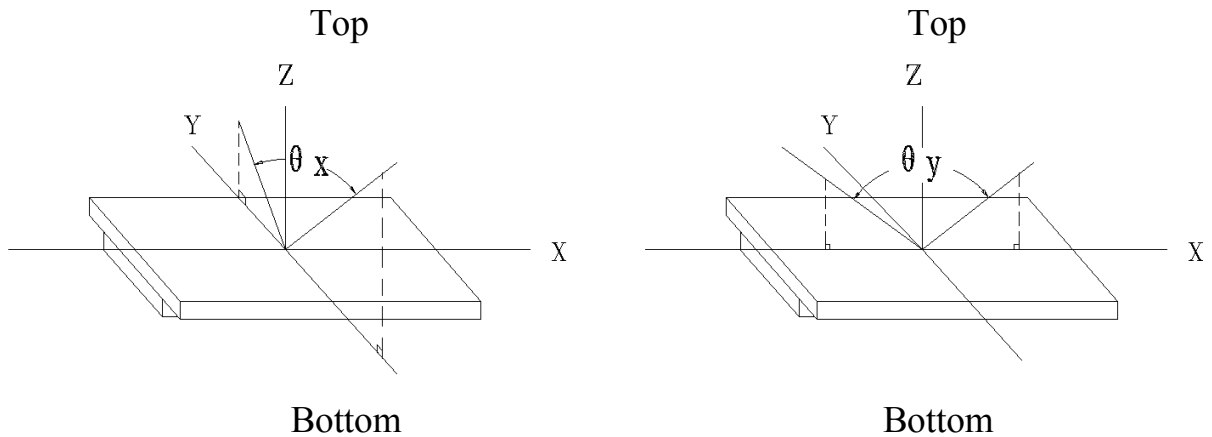

### 7.2.2 Definition of Contrast Ratio

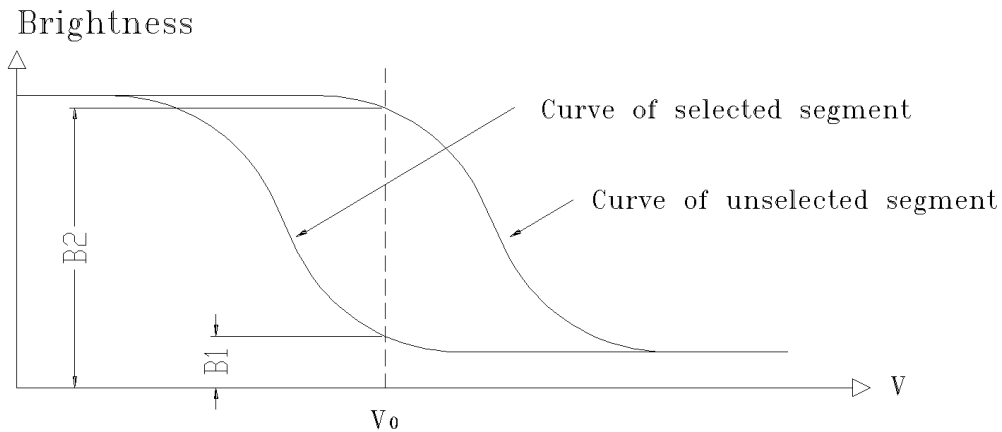

$$\text{Contrast Ratio} = B2/B1 = \frac{\text{unselected state brightness}}{\text{selected state brightness}}$$

Measuring Conditions:

- 1) Ambient Temperature: 25°C ;
- 2) Frame frequency: 42Hz

### 7.2.3 Definition of Response time

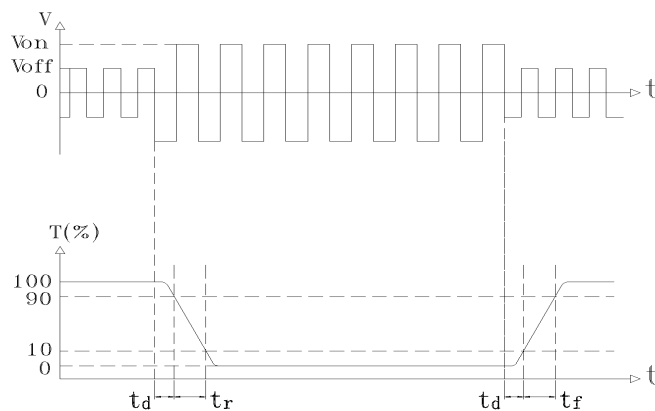

Turn on time:  $t_{on} = t_d + t_r$       Turn off time:  $t_{off} = t_d + t_f$

Measuring Condition:

- 1) Operating Voltage: 9.0V
- 2) Frame frequency: 42Hz

## 8 Reliability

### 8.1 Content of Reliability Test

Ta=25°C

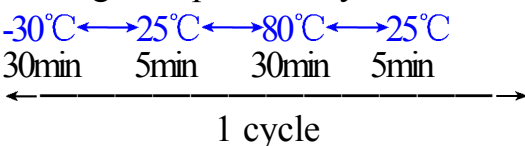
No.	Test Item	Content of Test	Test condition
1	High Temperature Storage	Endurance test applying the high storage temperature for a long time	80°C 240H
2	Low Temperature Storage	Endurance test applying the low storage temperature for a long time	-30°C 240H
3	High Temperature Operation	Endurance test applying the electric stress (voltage & current) and the thermal stress to the element for a long time	70°C 240H
4	Low Temperature Operation	Endurance test applying the electric stress under low temperature for a long time	-20°C 240H
5	High Temperature /Humidity Storage	Endurance test applying the high temperature and high humidity storage for a long time	60°C 95%RH 240H
6	Temperature Cycle	Endurance test applying the low and high temperature cycle 	-30°C/80°C 10 cycles
7	Vibration Test (package state)	Endurance test applying the vibration during transportation	10Hz~500Hz, 100m/s <sup>2</sup> , 120min
8	Shock Test (package state)	Endurance test applying the shock during transportation	Half- sine wave, 300m/s <sup>2</sup> , 18ms
9	Atmospheric Pressure Test	Endurance test applying the atmospheric pressure during transportation by air	25kPa 16H

## 8.2 Failure Judgment Criterion

Criterion Item	Test Item No.									Failure Judgement Criterion
	1	2	3	4	5	6	7	8	9	
Basic Specification	√	√	√	√	√	√	√	√	√	Out of the basic Specification
Electrical specification	√	√	√	√	√					Out of the electrical specification
Mechanical Specification							√	√		Out of the mechanical specification
Optical Characteristic	√	√	√	√	√	√			√	Out of the optical specification
Note	For test item refer to 8.1									
Remark	Basic specification = Optical specification + Mechanical specification									

## 9 QUALITY LEVEL

Examination or Test	At $T_a=25^\circ\text{C}$ (unless otherwise stated)	Inspection				
		Min.	Max.	Unit	IL	AQL
External Visual Inspection	Under normal illumination and eyesight condition, the distance between eyes and LCD is 25cm.	See Appendix A			II	Major 1.0 Minor 2.5
Display Defects	Under normal illumination and eyesight condition, display on inspection.	See Appendix B			II	Major 1.0 Minor 2.5
Note: Major defects: Open segment or common, Short, Serious damages, Leakage Miner defects: Others Sampling standard conforms to GB2828						



## **10 Precautions for Use of LCD Modules**

### 10.1 Handling Precautions

10.1.1 The display panel is made of glass. Do not subject it to a mechanical shock by dropping it from a high place, etc.

10.1.2 If the display panel is damaged and the liquid crystal substance inside it leaks out, be sure not to get any in your mouth, if the substance comes into contact with your skin or clothes, promptly wash it off using soap and water.

10.1.3 Do not apply excessive force to the display surface or the adjoining areas since this may cause the color tone to vary.

10.1.4 The polarizer covering the display surface of the LCD module is soft and easily scratched. Handle this polarizer carefully.

10.1.5 If the display surface is contaminated, breathe on the surface and gently wipe it with a soft dry cloth. If still not completely clear, moisten cloth with one of the following solvents:

- Isopropyl alcohol
- Ethyl alcohol

Solvents other than those mentioned above may damage the polarizer. Especially, do not use the following:

- Water
- Ketone
- Aromatic solvents

10.1.6 Do not attempt to disassemble the LCD Module.

10.1.7 If the logic circuit power is off, do not apply the input signals.

10.1.8 To prevent destruction of the elements by static electricity, be careful to maintain an optimum work environment.

- a. Be sure to ground the body when handling the LCD Modules.
- b. Tools required for assembly, such as soldering irons, must be properly ground.
- c. To reduce the amount of static electricity generated, do not conduct assembly and other work under dry conditions.
- d. The LCD Module is coated with a film to protect the display surface. Be care when peeling off this protective film since static electricity may be generated.

## 10.2 Storage precautions

10.2.1 When storing the LCD modules, avoid exposure to direct sunlight or to the light of fluorescent lamps.

10.2.2 The LCD modules should be stored under the storage temperature range.

If the LCD modules will be stored for a long time, the recommend condition is:

Temperature :  $0^{\circ}\text{C} \sim 40^{\circ}\text{C}$

Relatively humidity:  $\leq 80\%$

10.2.3 The LCD modules should be stored in the room without acid, alkali and harmful gas.

10.3 The LCD modules should be no falling and violent shocking during transportation, and also should avoid excessive press, water, damp and sunshine.

## Appendix A

### Inspection items and criteria for appearance defects

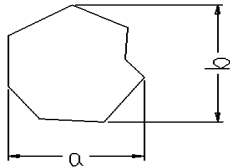
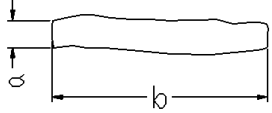
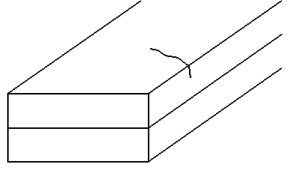
Items	Contents	Criteria		
Leakage		Not permitted		
Rainbow		According to the limit specimen		
Polarizer	Wrong polarizer attachment	Not permitted		
	Bubble between polarizer and glass	Not counted	Max. 3 defects allowed	
		$\phi < 0.3\text{mm}$	$0.3\text{mm} \leq \phi \leq 0.5\text{mm}$	
	Scratches of polarizer	According to the limit specimen		
Black spot (in viewing area)		Not counted	Max. 3 spots allowed	Max. 3 spots (lines) allowed
		$X < 0.2\text{mm}$	$0.2\text{mm} \leq X \leq 0.5\text{mm}$	
		$X = (a+b)/2$		
Black line (in viewing area)		Not counted	Max. 3 lines allowed	Max. 3 spots (lines) allowed
		$a < 0.02\text{mm}$	$0.02\text{mm} \leq a \leq 0.05\text{mm}$ $b \leq 2.0\text{mm}$	
Progressive cracks		Not permitted		

## Appendix A

### Inspection item and criteria for appearance defects (continued)

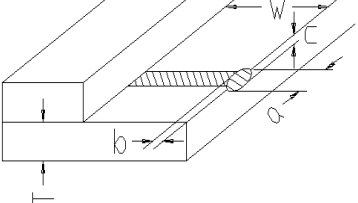
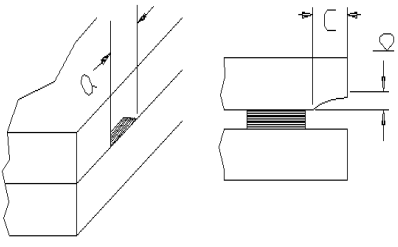
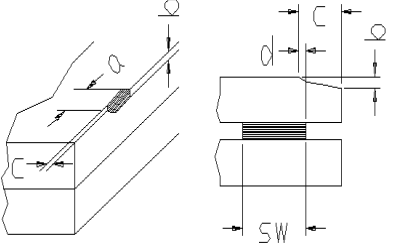
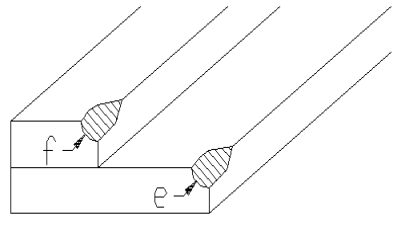
Items	Contents	Criteria				
Glass Cracks	<p>Cracks on pads</p> 	a	b	c	Max. 2 cracks allowed	Max. 5 cracks allowed
		$\leq 3\text{mm}$	$\leq W/5$	$\leq T/2$		
		$\leq 2\text{mm}$	$\leq W/5$	$T/2 < C < T$		
	<p>Cracks on contact side</p> 	a	b		Max. 2 cracks allowed	
		$\leq 3\text{mm}$	$\leq T/2$			
		$\leq 2\text{mm}$	$T/2 < b < T$			
		C shall be not reach the seal area				
	<p>Cracks on non-contact side</p> 	a	b		Max. 2 cracks allowed	
		$\leq 3\text{mm}$	$\leq T/2$			
		$\leq 2\text{mm}$	$T/2 < b < T$			
	$C \leq 0.5\text{mm}$					
<p>Corner cracks</p> 	$e < 2.0\text{mm}^2$ $f < 2.0\text{mm}^2$			Max. 3 cracks allowed		

## Appendix B

### Inspection items and criteria for display defects

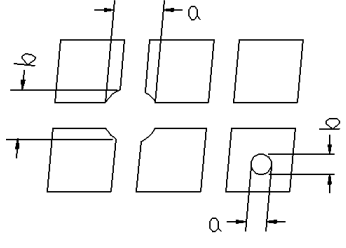
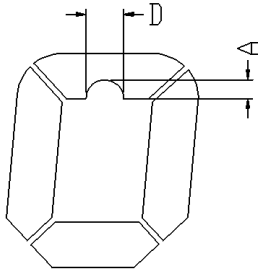
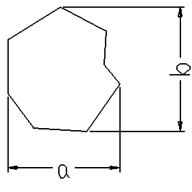
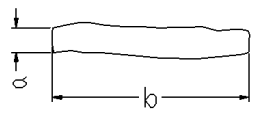
Items	Contents	Criteria			
Open segment or open common		Not permitted			
Short		Not permitted			
Wrong viewing angle		Not permitted			
Contrast ratio uneven		According to the limit specimen			
Crosstalk		According to the limit specimen			
Pin holes and cracks in segment (DOT)		Not counted	Max.3 dots allowed		Max.3 dots allowed
		$X < 0.1\text{mm}$	$0.1\text{mm} \leq X \leq 0.2\text{mm}$		
		$X = (a+b)/2$			
		Not counted	Max.2 dots allowed		
$A < 0.1\text{mm}$		$0.1\text{mm} \leq A \leq 0.2\text{mm}$ $D < 0.25\text{mm}$			
Black spot (in viewing area)		Not counted	Max.3 spots allowed		Max.3 spots (lines) allowed
		$X < 0.1\text{mm}$	$0.1\text{mm} \leq X \leq 0.2\text{mm}$		
		$X = (a+b)/2$			
Black line (in viewing area)		Not counted	Max.3 lines allowed		Max.3 spots (lines) allowed
		$a < 0.02\text{mm}$	$0.02\text{mm} \leq a \leq 0.05\text{mm}$ $b \leq 0.5\text{mm}$		

## Appendix B

### Inspection items and criteria for display defects (continued)

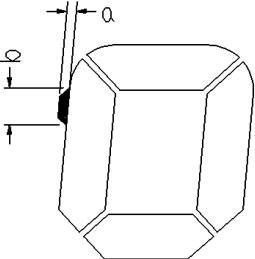
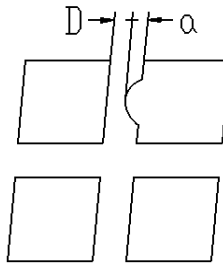
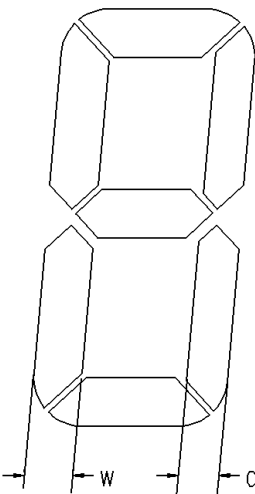
Items	Content	Criteria				
Transformation of segment		Not counted	Max. 2 defects allowed	Max.3 defects allowed		
		$x < 0.1\text{mm}$	$0.1\text{mm} \leq x \leq 0.2\text{mm}$			
		$x = (a+b)/2$				
		Not counted	Max. 1 defects allowed			
		$a < 0.1\text{mm}$	$0.1\text{mm} \leq a \leq 0.2\text{mm}$ $D > 0$			
		Max.2 defects allowed $0.8W \leq a \leq 1.2W$  $a = \text{measured value of width}$ $W = \text{nominal value of width}$				