

### Features and Benefits

- Wide operating voltage range from 2.5V to 24V
- High magnetic sensitivity – Multi-purpose
- CMOS technology
- Chopper-stabilized amplifier stage
  - Superior temperature stability
  - Extremely low switchpoint drift
  - Insensitive to physical stress
- Low current consumption
- Output driver with internal pull-up resistor
- Tiny SOT23 3L or flat SIP 3L both RoHS Compliant packages

### Application Examples

- Automotive, Consumer and Industrial
- Solid-state switch
- Brushless DC motor commutation
- Speed detection
- Linear position detection
- Angular position detection
- Proximity detection



### Functional Block Diagram

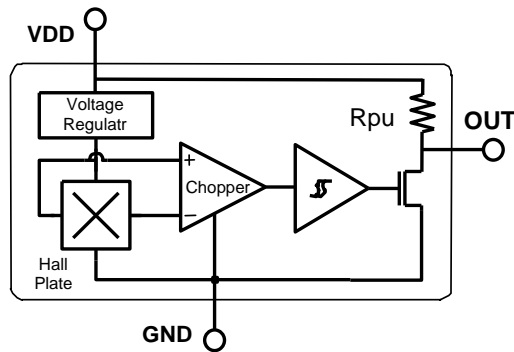

UA Package	SO Package
Pin 1 – V <sub>DD</sub>	Pin 1 – V <sub>DD</sub>
Pin 2 – GND	Pin 2 – OUT
Pin 3 – OUT	Pin 3 – GND

## General Description

The S732 is a bipolar Hall effect sensor IC fabricated from mixed signal CMOS technology. The device integrates a voltage regulator, Hall sensor with dynamic offset cancellation system, Schmitt trigger and an output driver with internal pull-up resistor, all in a single package. It incorporates advanced chopper stabilization techniques to provide accurate and stable magnetic switch points. There are many applications for this HED – Hall Electronic Device - in addition to those listed above. The design,

specifications and performance have been optimized for commutation applications in 5V and 12V brushless DC motors.

Thanks to its wide operating voltage range and extended choice of temperature range, it is quite suitable for use in automotive, industrial and consumer applications. The device is delivered in a Small Outline Transistor (SOT) for surface mount process or in a Plastic Single In Line (SIP 3L flat) for through-hole mount. Both 3-lead packages are RoHS compliant.

## Glossary of Terms

MilliTesla (mT),                      Units of magnetic flux density: 1mT = 10 Gauss

RoHS                                      Restriction of Hazardous Substances

SOT                                        Small Outline Transistor (SOT package) – also referred with the package code “SO”

ESD                                        Electro-Static Discharge

BLDC                                      Brush-Less Direct-Current

Operating Point ( $B_{OP}$ ) Magnetic flux density applied on the branded side of the package which turns the output driver ON

$$(V_{OUT} = V_{DSon})$$

Release Point ( $B_{RP}$ ) Magnetic flux density applied on the branded side of the package which turns the output driver OFF

$$(V_{OUT} = \text{high})$$

### Pin Definitions and Description

SOT Pin №	SIP Pin №	Name	Type	Function
1	1	VDD	Supply	Supply Voltage pin
2	3	OUT	Output	Open Drain Output pin
3	2	GND	Ground	Ground pin

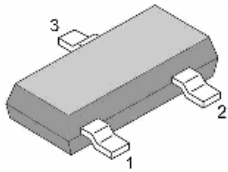

SOT-23

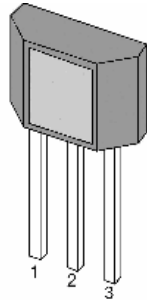

TO-92

### Detailed General Description

The S732 exhibits latch magnetic switching characteristics. Therefore, it requires both south and north poles to operate properly.

The OUT pin of these devices switches low (turns on) when a magnetic field perpendicular to the Hall sensor exceeds the operate point threshold,  $B_{OP}$ . After turn-on, the output voltage is  $V_{DSon}$ . Note that the device latches, that is, a south pole of sufficient strength towards the branded surface of the device turns the device on. The device remains on if the south pole is removed ( $B \rightarrow 0$ ). This latching property defines the device as a magnetic memory.

When the magnetic field is reduced below the release point,  $B_{RP}$ , the OUT pin turns off (goes high). The difference in the magnetic operate and release points is the hysteresis,  $B_{HYS}$ , of the device. This built-in hysteresis prevents output oscillation near the switching point, and allows clean switching of the output even in the presence of external mechanical vibration and electrical noise.

The device behaves as a latch with symmetric operating and release switching points ( $B_{OP} = |B_{RP}|$ ). This means magnetic fields with equivalent strength and opposite direction drive the output high and low.

Powering-on the device in the hysteresis region (less than  $B_{OP}$  and higher than  $B_{RP}$ ) allows an indeterminate output state. The correct state is attained after the first excursion beyond  $B_{OP}$  or  $B_{RP}$ .

The SOT-23 device is reversed from the UA package. The SOT-23 output transistor will be latched on in the presence of a sufficiently strong North pole magnetic field applied to the marked face.

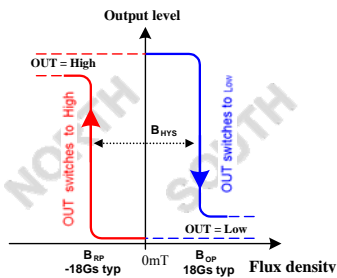

UA package - Latch characteristic

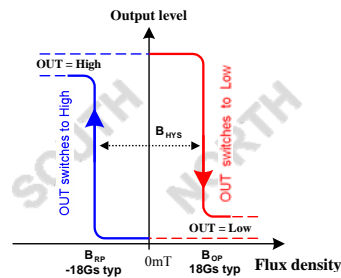

SO package - Latch characteristic

## Unique Features

Based on mixed signal CMOS technology, S732 is a Hall-effect device with high magnetic sensitivity. This multi-purpose latch meets most of the application requirements.

The chopper-stabilized amplifier uses switched capacitor technique to suppress the offset generally observed with Hall sensors and amplifiers. The CMOS technology makes this advanced technique possible and contributes to smaller chip size and lower current consumption than bipolar technology. The small chip size is also an important factor to minimize the effect of physical stress. This combination results in more stable magnetic characteristics and enables faster and more precise design.

The wide operating voltage from 2.5V to 24V, low current consumption and large choice of operating temperature range according to “L”, “K” and “E” specification make this device suitable for automotive, industrial and consumer applications.

## Absolute Maximum Ratings

Parameter	Symbol	Value	Units
Supply Voltage	VDD	28	V
Supply Current	IDD	50	mA
Output Voltage	VOUT	28	V
Output Current	IOUT	50	mA
Storage Temperature Range	TS	-50 to 150	°C
Maximum Junction Temperature	TJ	165	°C

### Absolute maximum ratings

Operating Temperature Range	Symbol	Value	Units
Temperature Suffix “E”	TA	-40 to 85	°C
Temperature Suffix “K”	TA	-40 to 125	°C
Temperature Suffix “L”	TA	-40 to 150	°C

Exceeding the absolute maximum ratings may cause permanent damage. Exposure to absolute-maximum- rated conditions for extended periods may affect device reliability.

### General Electrical Specifications

DC Operating Parameters  $T_A = 25^\circ\text{C}$ ,  $V_{DD} = 2.5\text{V}$  to  $24\text{V}$  (unless otherwise specified)

Parameter	Symbol	Test Conditions	Min	Typ	Max	Units
Supply Voltage	VDD	Operating	2.2		24	V
Supply Current	IDD	$B < B_{RP}$			5	mA
Output Saturation Voltage	VDSon	$I_{OUT} = 20\text{mA}$ , $B > B_{OP}$			0.5	V
Output Leakage Current	I <sub>OFF</sub>	$B < B_{RP}$ $V_{OUT} = 24\text{V}$		1	10	$\mu\text{A}$
Output Rise Time	T <sub>r</sub>	$R_L = 1\text{k}\Omega$ , $C_L = 20\text{pF}$		0.25		$\mu\text{s}$
Output Fall Time	T <sub>f</sub>	$R_L = 1\text{k}\Omega$ , $C_L = 20\text{pF}$		0.25		$\mu\text{s}$
Internal pull-up resistor	R <sub>pu</sub>	---	9	12	15	k $\Omega$
Maximum Switching Frequency	FSW	---		10		KHz
Package Thermal Resistance	RTH	Single layer (1S) Jedec board		301		$^\circ\text{C}/\text{W}$

Electrical specifications

**Note:** The output of S732 will be switched after the supply voltage is over 2.2V, but the magnetic characteristics won't be normal until the supply is over 2.5V.

### Magnetic Specifications

DC Operating Parameters  $V_{DD} = 2.5\text{V}$  to  $24\text{V}$  (unless otherwise specified)

Parameter	Symbol	Test Conditions	Min	Typ	Max	Units
Operating Point	$B_{OP}$	E spec., $T_A = 85^\circ\text{C}$	10	18	30	G
Release Point	$B_{RP}$		-30	-18	-10	G
Hysteresis	$B_{HYS}$			36		G
Parameter	Symbol	Test Conditions	Min	Typ	Max	Units
Operating Point	$B_{OP}$	K spec., $T_A = 85^\circ\text{C}$	7	18	35	G
Release Point	$B_{RP}$		-35	-18	-7	G
Hysteresis	$B_{HYS}$			36		G
Operating Point	$B_{OP}$	L spec., $T_A = 150^\circ\text{C}$	5	18	40	G
Release Point	$B_{RP}$		-40	-18	-5	G
Hysteresis	$B_{HYS}$			36		G

**批注 [PKU1]:** 这个不对, 从图上看滞后工作区应位于操作点和释放点之间, 建议删了这项, 因为它取决于那两个点, 同时还要加 K 系列的值, 只能估算了

**批注 [PKU2]:** 这个不对, 从图上看滞后工作区应位于操作点和释放点之间, 建议删了这项, 因为它取决于那两个点, 同时还要加 K 系列的值, 只能估算了

Magnetic specifications

### Output Behaviour versus Magnetic Pole

DC Operating Parameters  $T_A = -40\text{ C to }150\text{ C}$ ,  $V_{DD} = 2.5\text{V to }24\text{V}$  (unless otherwise specified)

Parameter	Test Conditions(SO)	OUT(SO)	Test Conditions(UA)	OUT(UA)
South pole	$B < B_{RP}$	High	$B > B_{OP}$	Low
North pole	$B > B_{OP}$	Low	$B < B_{RP}$	High

Output behaviour versus magnetic pole

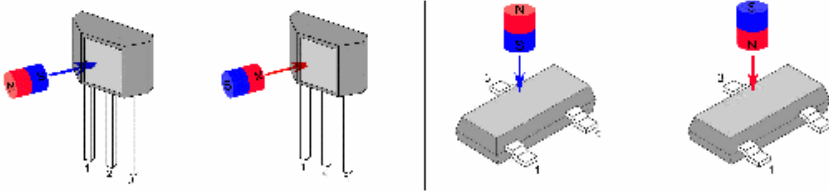

### Application Information

It is strongly recommended that an external bypass capacitor be connected (in close proximity to the Hall sensor) between the supply(VDD Pin) and ground(GND Pin) of the device to reduce both external noise and noise generated by the chopper stabilization technique. As is shown in the two figures in next page, a 0.1 $\mu\text{F}$  capacitor is typical.

For reverse voltage protection, it is recommended to connect a resistor or a diode in series with the VDD pin. When using a resistor, three points are important:

- the resistor has to limit the reverse current to 50mA maximum ( $V_{CC} / R1 \leq 50\text{mA}$ )
- the resulting device supply voltage VDD has to be higher than VDD min ( $V_{DD} = V_{CC} - R1 \cdot I_{DD}$ )
- the resistor has to withstand the power dissipated in reverse voltage condition ( $P_D = V_{CC}^2 / R1$ )

Using a diode, a reverse current cannot flow and the voltage drop is almost constant ( $\approx 0.7\text{V}$ ).

Therefore, a 100 $\Omega$ /0.25W resistor for 5V application and a diode for higher supply voltage are recommended. Both solutions provide the required reverse voltage protection.

When a weak power supply is used or when the device is intended to be used in noisy environment, it is recommended that figure 13.3 from the Application Information section is used.

The low-pass filter formed by R1 and C1 and the Zener diode Z1 bypass the disturbances or voltage spikes occurring on the device supply voltage VDD. The diode D1 provides additional reverse voltage protection.

**Typical Three-Wire Application Circuit**

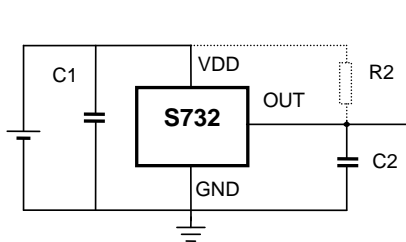

**Automotive and Severe Environment Protection Circuit**

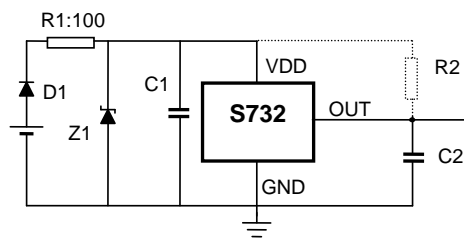

The S732 have been optimized for commutation applications in 5V and 12V brushless DC motors. The follow figure is the typical application circuit for 3 phase brushless DC motors.

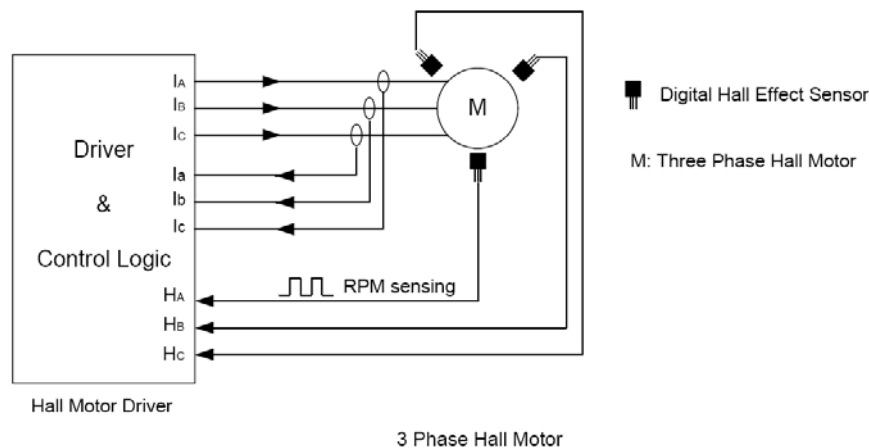

### Standard information regarding manufacturability of Hall IC with different soldering processes

Our products are classified and qualified regarding soldering technology, solderability and moisture sensitivity level according to following test methods:

#### Reflow Soldering SMD's (Surface Mount Devices)

- IPC/JEDEC J-STD-020  
Moisture/Reflow Sensitivity Classification for Nonhermetic Solid State Surface Mount Devices  
(classification reflow profiles according to table 5-2)
- EIA/JEDEC JESD22-A113  
Preconditioning of Nonhermetic Surface Mount Devices Prior to Reliability Testing  
(reflow profiles according to table 2)

#### Wave Soldering SMD's (Surface Mount Devices) and THD's (Through Hole Devices)

- EN60749-20  
Resistance of plastic- encapsulated SMD's to combined effect of moisture and soldering heat
- EIA/JEDEC JESD22-B106 and EN60749-15  
Resistance to soldering temperature for through-hole mounted devices

#### Iron Soldering THD's (Through Hole Devices)

- EN60749-15  
Resistance to soldering temperature for through-hole mounted devices

#### Solderability SMD's (Surface Mount Devices) and THD's (Through Hole Devices)

- EIA/JEDEC JESD22-B102 and EN60749-21  
Solderability

### ESD Precautions

Electronic semiconductor products are sensitive to Electro Static Discharge (ESD).

Always observe Electro Static Discharge control procedures whenever handling semiconductor products.

### Package Information

Package UA, 3-Pin SIP:

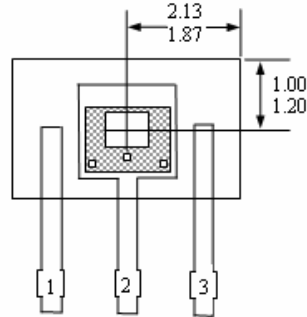
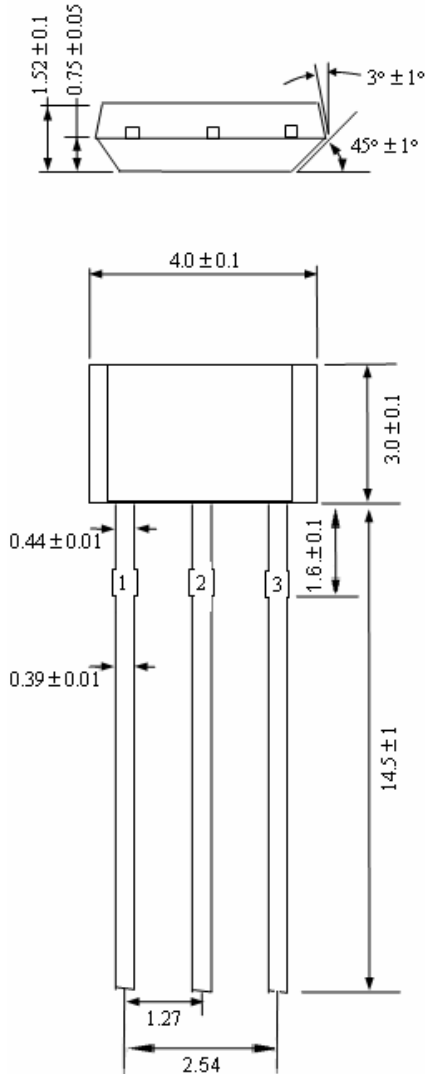

Sensor Location

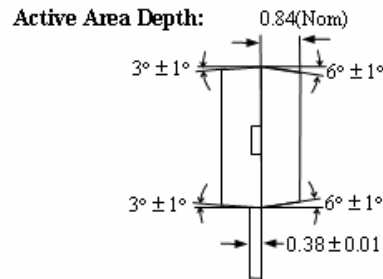

#### Notes:

- 1). Controlling dimension : mm ;
- 2). Leads must be free of flash and plating voids ;
- 3). Do not bend leads within 1 mm of lead to package interface ;
- 4). PINOUT: Pin 1 VDD  
Pin 2 GND  
Pin 3 Output



**Package SO, 3-Pin SOT-23:**

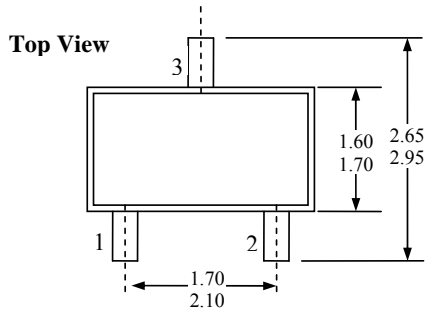

Notes:

- 1). PINOUT: Pin 1 VDD  
Pin 2 Output  
Pin 3 GND
- 2). All dimensions are in millimeters ;

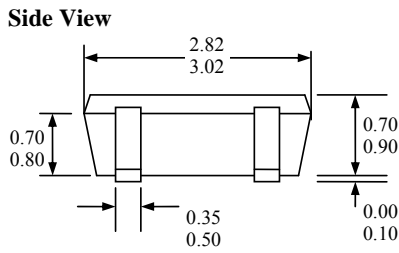

**End View**

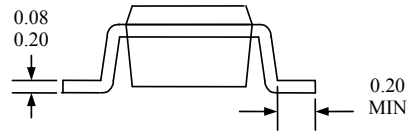

**Hall plate location**

Bottom View of TSOT-23

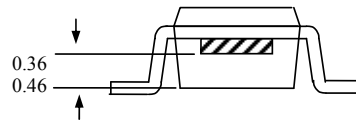
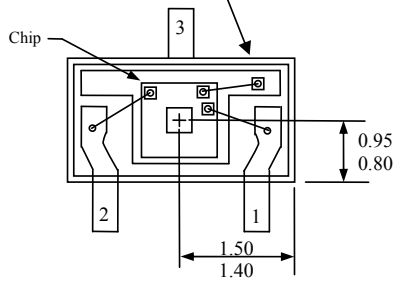

**Ordering Information**

Part No.	Pb-free	Temperature Code	Package Code	Packing
SS732ESOT/ SS632ESOT	YES	-40°C to 85°C	SOT-23	7-in. reel, 3000 pieces/ reel
SS732EUA/ SS632EUA	YES	-40°C to 85°C	TO-92	Bulk, 1000 pieces/ bag
SS732KSOT/ SS632KSOT	YES	-40°C to 125°C	SOT-23	7-in. reel, 3000 pieces/ reel
SS732KUA/ SS632KUA	YES	-40°C to 125°C	TO-92	Bulk, 1000 pieces/ bag
SS732LSOT/ SS632LSOT	YES	-40°C to 150°C	SOT-23	7-in. reel, 3000 pieces/ reel
SS732LUA/ SS632LUA	YES	-40°C to 150°C	TO-92	Bulk, 1000 pieces/ bag