

# 200mA, Automotive, Ultra-Low Quiescent Current, Linear Regulator

## General Description

The MAX16910 ultra-low quiescent current, high-voltage linear regulator is ideal for use in automotive and battery-operated systems. The device operates from a +3.5V to +30V input voltage, delivers up to 200mA of load current, and consumes only 20 $\mu$ A of quiescent current at no load. The device consumes only 1.6 $\mu$ A current when in shutdown. The input is +45V transient tolerant and is designed to operate under load-dump conditions. The MAX16910 can be configured as either fixed output voltage (+3.3V or +5V) or adjustable output voltage using an external resistive divider.

The MAX16910 features an open-drain, active-low  $\overline{\text{RESET}}$  output with fixed thresholds offered at 92.5% and 87.5% of the output voltage. The  $\overline{\text{RESET}}$  output remains low for a fixed period of 60 $\mu$ s after the output voltage exceeds its threshold. The  $\overline{\text{RESET}}$  delay can be extended with an external capacitor.

The MAX16910 includes an enable input, short-circuit protection, and thermal shutdown. The MAX16910 operates over the -40 $^{\circ}$ C to +125 $^{\circ}$ C automotive temperature range. The device is available in a space-saving, thermally enhanced, 3mm x 3mm, 8-pin TDFN package and 5mm x 4mm, 8-pin SO package.

## Applications

Automotive  
Industrial  
Telecom

## Features

- ◆ Low 20 $\mu$ A Quiescent Current
- ◆ +3.5V to +30V Wide Input Voltage Range, +45V Tolerant
- ◆ Operates Through Cold-Crank Conditions
- ◆ Low-Dropout Voltage of 280mV at 200mA
- ◆ Up to 200mA Output Current Capability
- ◆ Stable Operation with Tiny 4.7 $\mu$ F Output Capacitor
- ◆ User-Selectable Output Voltage
  - +3.3V or +5V Fixed
  - +1.5V to +11V Adjustable with External Resistive Divider
- ◆ Open-Drain RESET Output with Adjustable Delay
- ◆ Fixed-Reset Threshold Options: 87.5% or 92.5%
- ◆ High-Voltage Enable Input (+45V)
- ◆ Thermal and Short-Circuit Protection
- ◆ Operating -40 $^{\circ}$ C to +125 $^{\circ}$ C Temperature Range
- ◆ Operating -40 $^{\circ}$ C to +150 $^{\circ}$ C (T<sub>J</sub>) Temperature Range
- ◆ Automotive Qualified

## Typical Operating Circuits

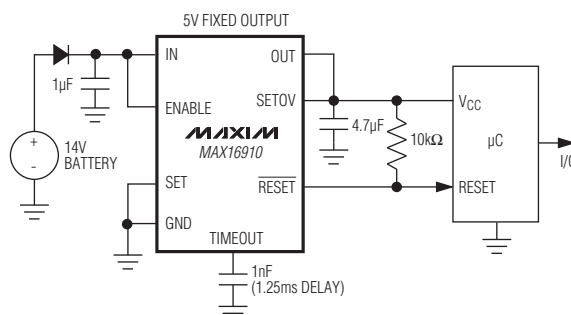

Typical Operating Circuits continued on next page.

[Ordering Information/Selector Guide](#) appears at end of data sheet.

# 200mA, Automotive, Ultra-Low Quiescent Current, Linear Regulator

## Typical Operating Circuits (continued)

MAX16910

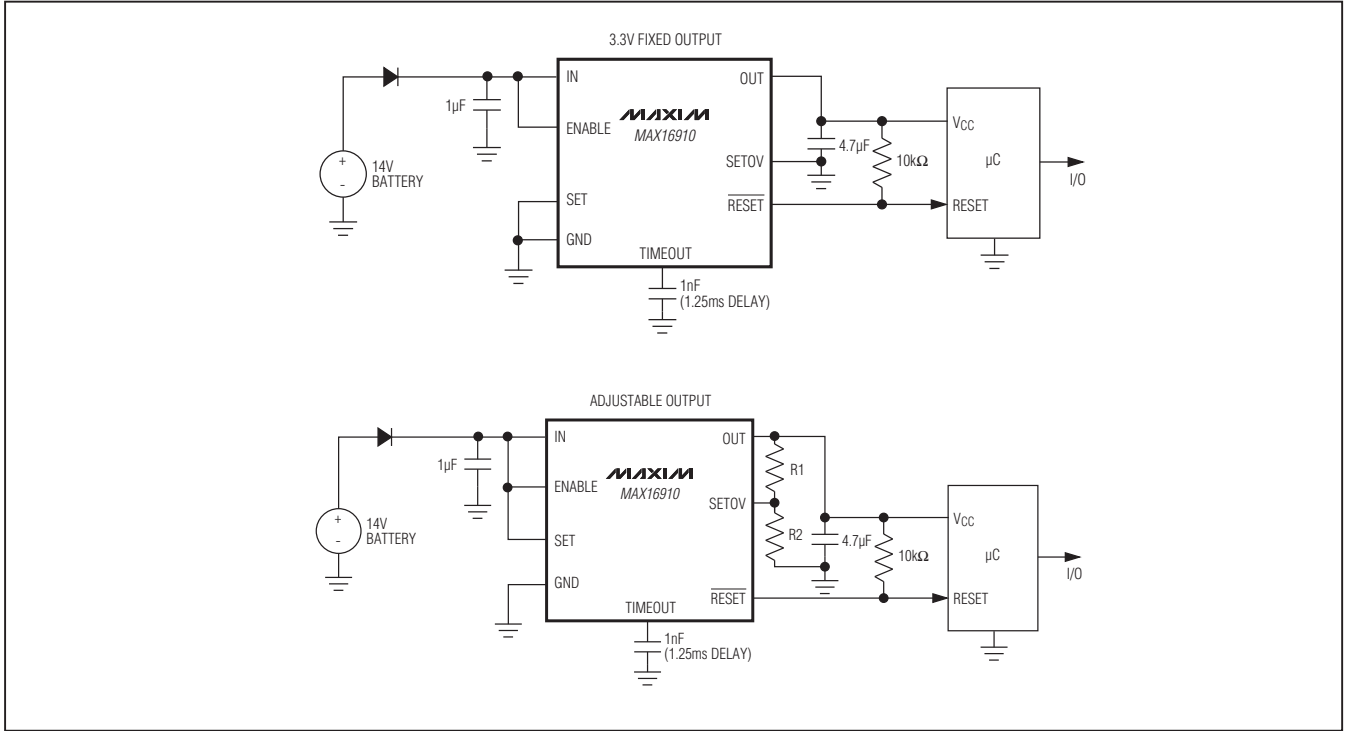

# 200mA, Automotive, Ultra-Low Quiescent Current, Linear Regulator

## Pin Configurations

**MAX16910**

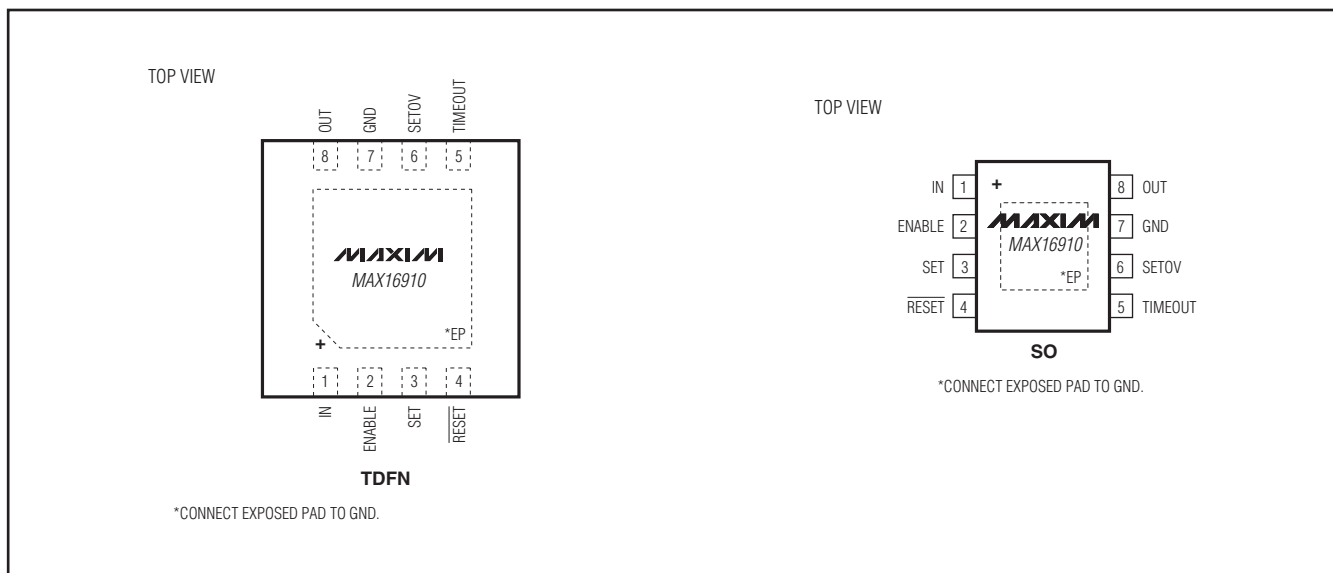

# 200mA, Automotive, Ultra-Low Quiescent Current, Linear Regulator

**MAX16910**

## ABSOLUTE MAXIMUM RATINGS

(All voltages referenced to GND.)

IN, ENABLE, SET.....	-0.3V to +45V
OUT, RESET (open-drain output).....	-0.3V to +12V
SETOV, TIMEOUT.....	-0.3V to +6V
Maximum Current (all pins except IN and OUT).....	50mA
Continuous Power Dissipation (T <sub>A</sub> = +70°C)	
TDFN (derate 24.4mW/°C above +70°C)*.....	1951mW
SO (derate 23.3mW/°C above +70°C)*.....	1861mW

Operating Temperature Range.....	-40°C to +125°C
Junction Temperature.....	+150°C
Storage Temperature Range.....	-65°C to +150°C
Lead Temperature (soldering, 10s).....	+300°C
Soldering Temperature (reflow) .....	+260°C

\*As per JEDEC51 Standard (multilayer board).

## PACKAGE THERMAL CHARACTERISTICS (Note 1)

TDFN	Junction-to-Ambient Thermal Resistance (θ <sub>JA</sub> ).....	41°C/W	SO	Junction-to-Ambient Thermal Resistance (θ <sub>JA</sub> ).....	43°C/W
	Junction-to-Case Thermal Resistance (θ <sub>JC</sub> ).....	8°C/W		Junction-to-Case Thermal Resistance (θ <sub>JC</sub> ).....	7°C/W

**Note 1:** Package thermal resistances were obtained using the method described in JEDEC specification JESD51-7, using a four-layer board. For detailed information on package thermal considerations, refer to [www.maxim-ic.com/thermal-tutorial](http://www.maxim-ic.com/thermal-tutorial).

Stresses beyond those listed under "Absolute Maximum Ratings" may cause permanent damage to the device. These are stress ratings only, and functional operation of the device at these or any other conditions beyond those indicated in the operational sections of the specifications is not implied. Exposure to absolute maximum rating conditions for extended periods may affect device reliability.

## ELECTRICAL CHARACTERISTICS

(V<sub>IN</sub> = V<sub>ENABLE</sub> = +14V, C<sub>TIMEOUT</sub> = open, C<sub>IN</sub> = 1μF, C<sub>OUT</sub> = 4.7μF, unless otherwise noted. T<sub>A</sub> = -40°C to +125°C, T<sub>A</sub> ≤ T<sub>J</sub> ≤ +150°C, unless otherwise noted. Typical values are T<sub>A</sub> = +25°C.) (Note 2)

PARAMETER	SYMBOL	CONDITIONS	MIN	TYP	MAX	UNITS
Supply Voltage Range	V <sub>IN</sub>	Continuous	3.5		30	V
		For ≤ 400ms			45	
Supply Current		I <sub>LOAD</sub> = 0mA, SET = GND, V <sub>OUT</sub> = 5V		20	30	μA
Shutdown Supply Current	I <sub>SHDN</sub>	ENABLE = GND, T <sub>A</sub> = +25°C		1.6	3	μA
		ENABLE = GND, -40°C ≤ T <sub>A</sub> ≤ +125°C		3		
Output Voltage (5V Fixed Output Setting)	V <sub>OUT50</sub>	1mA ≤ I <sub>LOAD</sub> ≤ 200mA, V <sub>IN</sub> = 6V to 30V (Note 3)	4.9	5.0	5.1	V
		1mA ≤ I <sub>LOAD</sub> ≤ 50mA, V <sub>IN</sub> = 6V to 30V, T <sub>J</sub> = +150°C (Notes 3, 4)	4.9	5.0	5.1	
Output Voltage (3.3V Fixed Output Setting)	V <sub>OUT33</sub>	1mA ≤ I <sub>LOAD</sub> ≤ 200mA, V <sub>IN</sub> = 4.8V to 30V (Note 3)	3.234	3.3	3.366	V
		1mA ≤ I <sub>LOAD</sub> ≤ 50mA, V <sub>IN</sub> = 4.8V to 30V, T <sub>J</sub> = +150°C (Notes 3, 4)	3.234	3.3	3.366	
Adjustable Output-Voltage Range	V <sub>OUT</sub>		1.5		11.0	V
SETOV FB Voltage	V <sub>SETOV</sub>	I <sub>LOAD</sub> = 1mA (Note 4)	1.225	1.25	1.275	V
Dropout Voltage (Note 5)	ΔV <sub>DO</sub>	I <sub>LOAD</sub> = 200mA, SET = GND, SETOV = HIGH, V <sub>OUT(NORM)</sub> = +5.0V		280	600	mV
		I <sub>LOAD</sub> = 50mA, SET = GND, SETOV = HIGH, V <sub>OUT(NORM)</sub> = +5.0V, T <sub>J</sub> = +150°C (Notes 3, 4)			600	

# 200mA, Automotive, Ultra-Low Quiescent Current, Linear Regulator

MAX16910

## ELECTRICAL CHARACTERISTICS (continued)

( $V_{IN} = V_{ENABLE} = +14V$ ,  $C_{TIMEOUT} = \text{open}$ ,  $C_{IN} = 1\mu F$ ,  $C_{OUT} = 4.7\mu F$ , unless otherwise noted.  $T_A = -40^\circ C$  to  $+125^\circ C$ ,  $T_A \leq T_J \leq +150^\circ C$ , unless otherwise noted. Typical values are  $T_A = +25^\circ C$ .) (Note 2)

PARAMETER	SYMBOL	CONDITIONS	MIN	TYP	MAX	UNITS
Short-Circuit Output Current Limit	I <sub>SC</sub>	Output shorted to GND (MAX16910C__)	230	330		mA
Thermal Shutdown		(Note 6)		+180		°C
Thermal Shutdown Hysteresis		(Note 6)		+25		°C
Line Regulation (5V Fixed Output Setting)		$V_{IN} = 6V$ to $30V$ , $I_{LOAD} = 1mA$		1		mV
Line Regulation (3.3V Fixed Output Setting)		$V_{IN} = 4.8V$ to $30V$ , $I_{LOAD} = 1mA$		1		mV
Load Regulation (5V Fixed Output Setting)		$I_{LOAD} = 1mA$ to $200mA$		12		mV
Load Regulation (3.3V Fixed Output Setting)		$I_{LOAD} = 1mA$ to $200mA$		12		mV
Power-Supply Rejection Ratio	PSRR	$I_{LOAD} = 10mA$ , $f = 100Hz$ , $500mV_{P-P}$ (Note 6)		60		dB
Startup Response Time	t <sub>START</sub>	Rising edge of $V_{IN}$ to $V_{OUT}$ , $I_{LOAD} = 50mA$ (Note 6)		160		μs
<b>TIMEOUT INPUT</b>						
TIMEOUT Ramp Current	I <sub>TO</sub>	TIMEOUT connected to GND	0.600	1.0	1.650	μA
TIMEOUT Ramp Delay				1.25		ms/nF
RESET Default Timeout Period		$V_{OUT}$ rising, TIMEOUT = OPEN	30	60	90	μs
<b>RESET OUTPUT</b>						
RESET Threshold		MAX16910__9/V+, $V_{OUT}$ falling	90	92.5	94	% of $V_{OUT}$
		MAX16910__8/V+, $V_{OUT}$ falling	85	87.5	89	
RESET Threshold Hysteresis		$V_{OUT}$ rising		5		% of $V_{OUT}$
OUT to RESET Delay		$V_{OUT}$ falling (Note 6)		4		μs
RESET Output-Voltage Low (Open-Drain)	V <sub>OL</sub>	$I_{SINK} = 0.5mA$ , RESET asserted			0.4	V
RESET Open-Drain Leakage Current		RESET not asserted, RESET = 7V, $T_A = +25^\circ C$			1	μA
RESET Open-Drain Leakage Current		RESET not asserted, RESET = 7V		0.03		μA
<b>ENABLE</b>						
ENABLE Logic-Low	V <sub>IL</sub>				0.4	V
ENABLE Logic-High	V <sub>IH</sub>		2.4			V
ENABLE Pulldown Current		(Note 7)		0.65		μA
<b>SET INPUT</b>						
SET Input Current (All Modes)		$T_A = +25^\circ C$	-50		+50	nA
		$T_J = +150^\circ C$		0.2		μA
SET Logic-Low	V <sub>ILSET</sub>				0.4	V
Set Logic-High	V <sub>IHSET</sub>		2.4			V

# 200mA, Automotive, Ultra-Low Quiescent Current, Linear Regulator

MAX16910

## ELECTRICAL CHARACTERISTICS (continued)

( $V_{IN} = V_{ENABLE} = +14V$ ,  $C_{TIMEOUT} = \text{open}$ ,  $C_{IN} = 1\mu F$ ,  $C_{OUT} = 4.7\mu F$ , unless otherwise noted.  $T_A = -40^\circ C$  to  $+125^\circ C$ ,  $T_A \leq T_J \leq +150^\circ C$ , unless otherwise noted. Typical values are  $T_A = +25^\circ C$ .) (Note 2)

PARAMETER	SYMBOL	CONDITIONS	MIN	TYP	MAX	UNITS
<b>SETOV INPUT (TRI-MODE)</b>						
SETOV Input Leakage Current		SET = HIGH, $V_{SETOV} = 5V$ or SET = GND, $V_{SETOV} = 5V$		1		$\mu A$
SETOV Low-Level Input Voltage	$V_{ILSETOV}$	SET = GND, $V_{SETOV} < V_{ILSETOV}$ or places device in +3.3V fixed output-voltage mode			0.4	V
SETOV High-Level Input Voltage	$V_{IHSETOV}$	SET = GND, $V_{SETOV} > V_{IHSETOV}$ or places device in +5V fixed output-voltage mode	$V_{OUT} - 0.4$			V

**Note 2:** Production tested at  $T_A = +25^\circ C$ . Overtemperature limits are guaranteed by ATE characterization between  $-40^\circ C \leq T_J \leq +150^\circ C$ , unless otherwise noted.

**Note 3:** Observe the absolute maximum power dissipation limits.

**Note 4:** Specification characterized up to  $+150^\circ C$  operating junction temperature. Limits are guaranteed by bench characterization.

**Note 5:** Dropout voltage is defined as  $(V_{IN} - V_{OUT})$  when  $V_{OUT}$  is 2% below the value of  $V_{OUT}$  for  $V_{IN} = V_{OUT} + 3V$ .

**Note 6:** Not production tested.

**Note 7:** ENABLE is internally pulled to GND.

# 200mA, Automotive, Ultra-Low Quiescent Current, Linear Regulator

## Typical Operating Characteristics

( $V_{IN} = V_{EN} = +14V$ ,  $C_{IN} = 1\mu F$ ,  $C_{OUT} = 4.7\mu F$  ceramic,  $T_A = +25^\circ C$ , unless otherwise noted.)

**MAX16910**

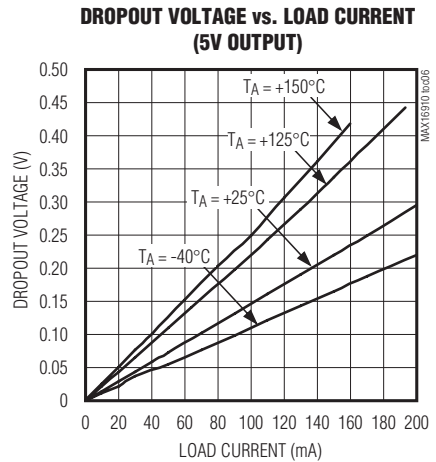
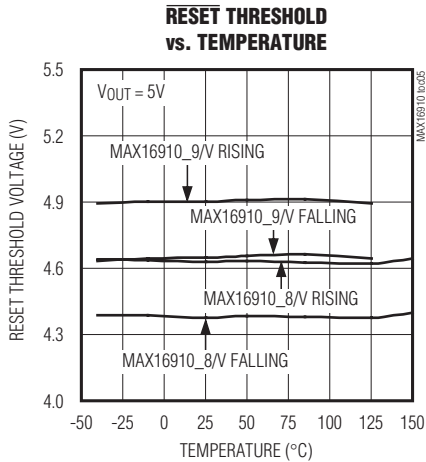
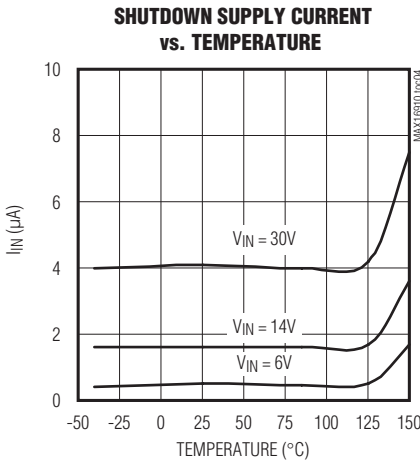
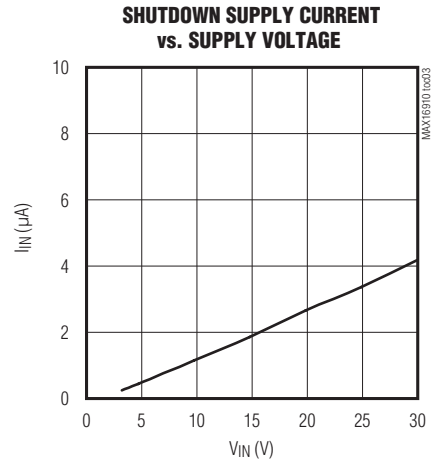
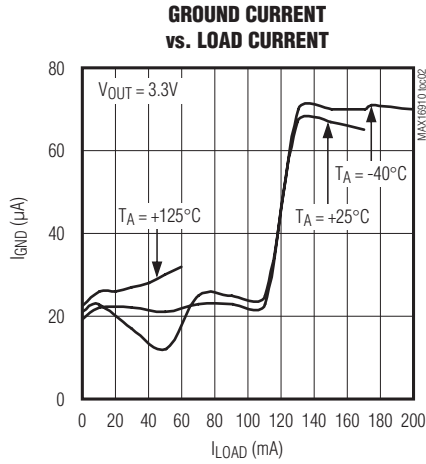
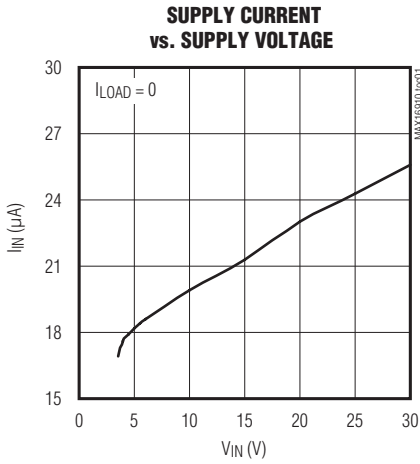

# 200mA, Automotive, Ultra-Low Quiescent Current, Linear Regulator

## Typical Operating Characteristics (continued)

( $V_{IN} = V_{EN} = +14V$ ,  $C_{IN} = 1\mu F$ ,  $C_{OUT} = 4.7\mu F$  ceramic,  $T_A = +25^\circ C$ , unless otherwise noted.)

**DROPOUT VOLTAGE vs. LOAD CURRENT (3.3V OUTPUT)**

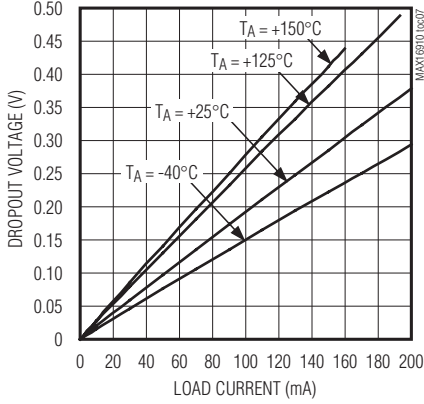

**OUTPUT VOLTAGE vs. SUPPLY VOLTAGE**

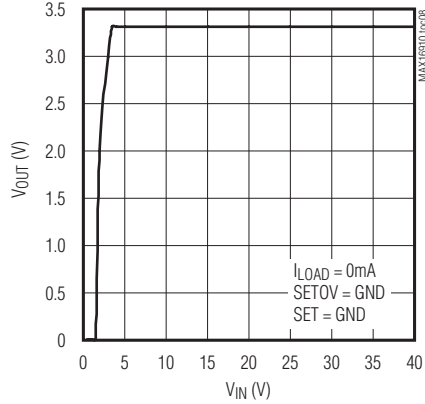

**OUTPUT VOLTAGE vs. SUPPLY VOLTAGE**

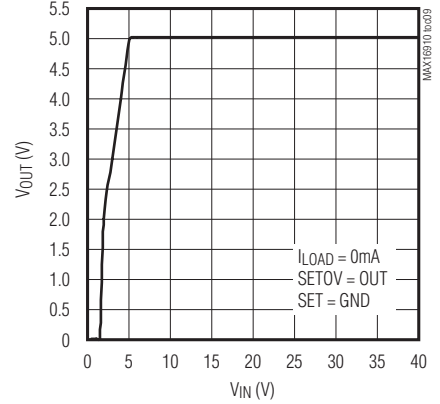

**OUTPUT VOLTAGE vs. TEMPERATURE**

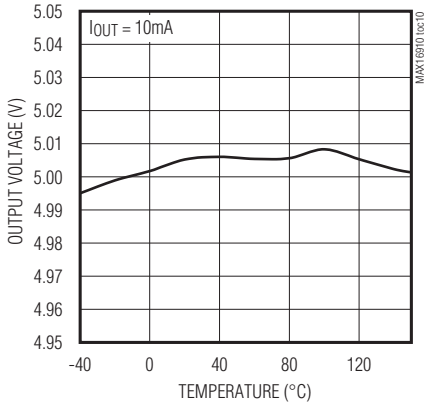

**RESET TIMEOUT PERIOD vs. TEMPERATURE**

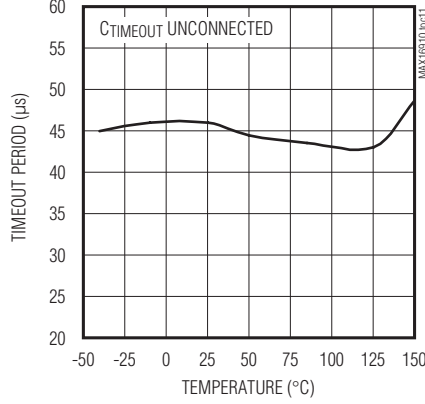

**POWER-SUPPLY REJECTION RATIO vs. FREQUENCY**

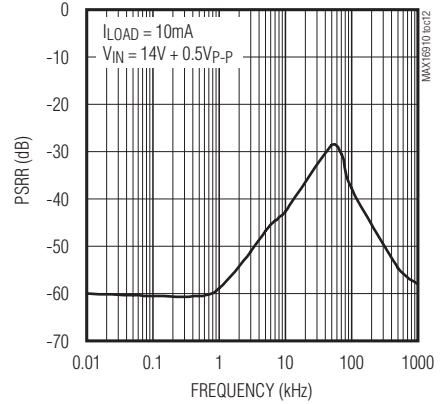



# 200mA, Automotive, Ultra-Low Quiescent Current, Linear Regulator

**MAX16910**

## Typical Operating Characteristics (continued)

( $V_{IN} = V_{EN} = +14V$ ,  $C_{IN} = 1\mu F$ ,  $C_{OUT} = 4.7\mu F$  ceramic,  $T_A = +25^\circ C$ , unless otherwise noted.)

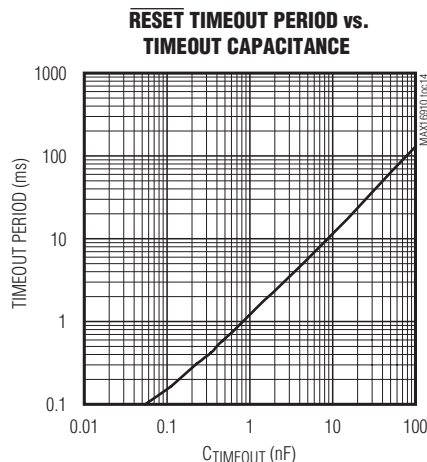
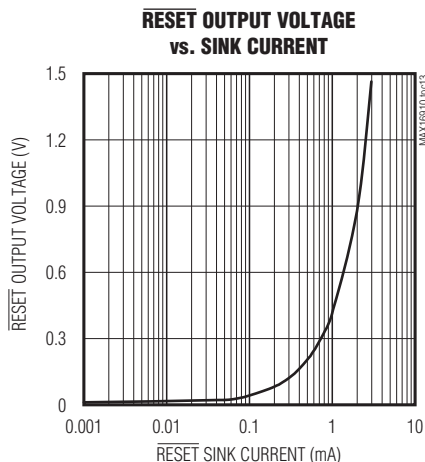

**LOAD-TRANSIENT RESPONSE (5V OUTPUT)**

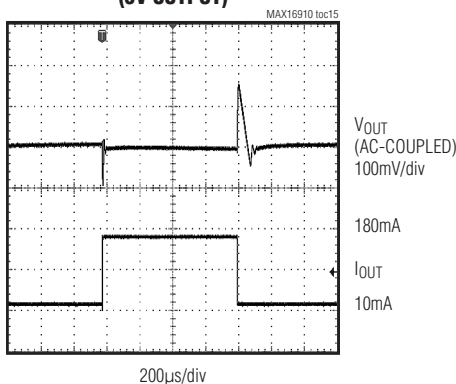

**LOAD-TRANSIENT RESPONSE (3V OUTPUT)**

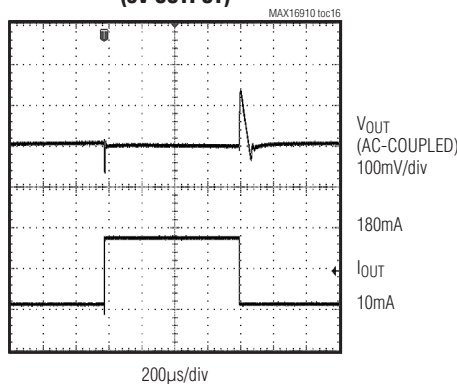

**LINE-TRANSIENT RESPONSE (5V OUTPUT)**

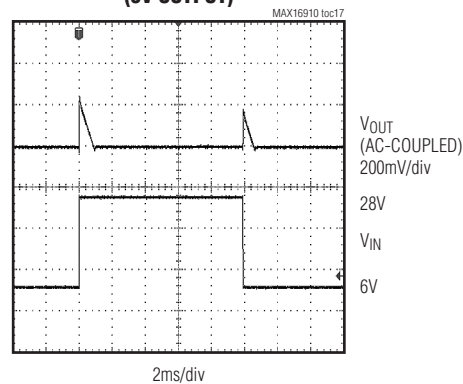

**LINE-TRANSIENT RESPONSE (3.3V OUTPUT)**

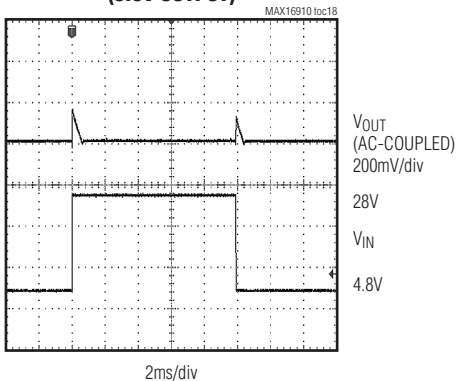

**POWER-UP RESPONSE**

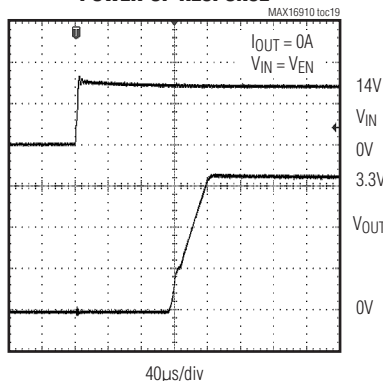

**POWER-UP RESPONSE**

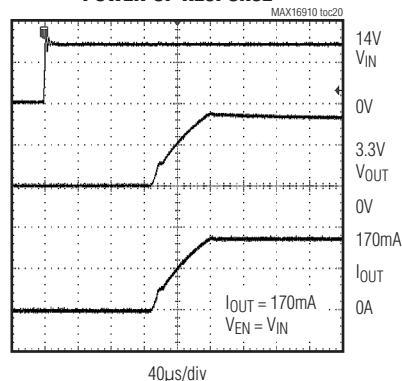

# 200mA, Automotive, Ultra-Low Quiescent Current, Linear Regulator

## Typical Operating Characteristics (continued)

( $V_{IN} = V_{EN} = +14V$ ,  $C_{IN} = 1\mu F$ ,  $C_{OUT} = 4.7\mu F$  ceramic,  $T_A = +25^\circ C$ , unless otherwise noted.)

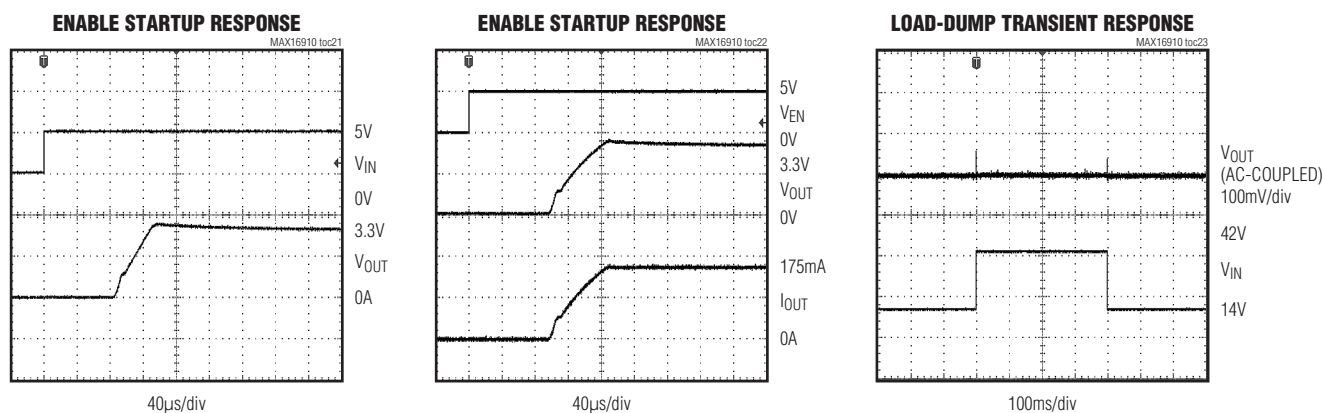

## Pin Description

PIN	NAME	FUNCTION
1	IN	Regulator Input. Bypass IN to GND with a 1 $\mu F$ (min) low-ESR ceramic capacitor.
2	ENABLE	Active-High Enable Input. Force ENABLE high (or connect to IN) to turn the regulator on. Pull ENABLE low (or leave unconnected) to place the device in a low-power shutdown mode. ENABLE is internally pulled down to GND through a 0.65 $\mu A$ current sink.
3	SET	Feedback Network Selector. Connect SET to GND when operating the MAX16910 in fixed output-voltage mode (3.3V or 5V) using the internal feedback network. Connect SET to IN or any voltage higher than 2.4V when an external feedback network (resistive divider) is used, operating the MAX16910 in adjustable output-voltage mode.
4	$\overline{\text{RESET}}$	Active-Low, Open-Drain Reset Output. $\overline{\text{RESET}}$ asserts low when OUT is below the reset threshold, and remains low for the duration of the reset timeout period after the reset conditions end. $\overline{\text{RESET}}$ also asserts low when ENABLE is low and during thermal shutdown.
5	TIMEOUT	Reset-Timeout-Period Adjust Input. Internal capacitance produces a 60 $\mu s$ default delay when TIMEOUT is left unconnected. Connect a capacitor from TIMEOUT to GND to set a longer timeout period than default.
6	SETOV	Regulated Output-Voltage Selector. Connect SETOV to OUT for a 5V fixed output, or connect SETOV to GND for a 3.3V fixed output. SETOV becomes the feedback path when using an external resistive divider for an adjustable output.
7	GND	Ground
8	OUT	Regulator Output. Bypass OUT to GND with a minimum of 4.7 $\mu F$ . Use a low-ESR, ceramic capacitor (X7R, X5R) for optimal performance. The SETOV input controls the output voltage when in fixed +3.3V or fixed +5V output-voltage mode. Using an external resistive divider between OUT and SETOV sets adjustable output voltage from +1.5V to +11V.
—	EP	Exposed Pad. EP is internally connected to GND. Connect EP to the ground plane to provide a low thermal-resistance path from the thermal junction to the PCB. Do not use EP as the only electrical connection to GND.

# 200mA, Automotive, Ultra-Low Quiescent Current, Linear Regulator

## Functional Diagram

MAX16910

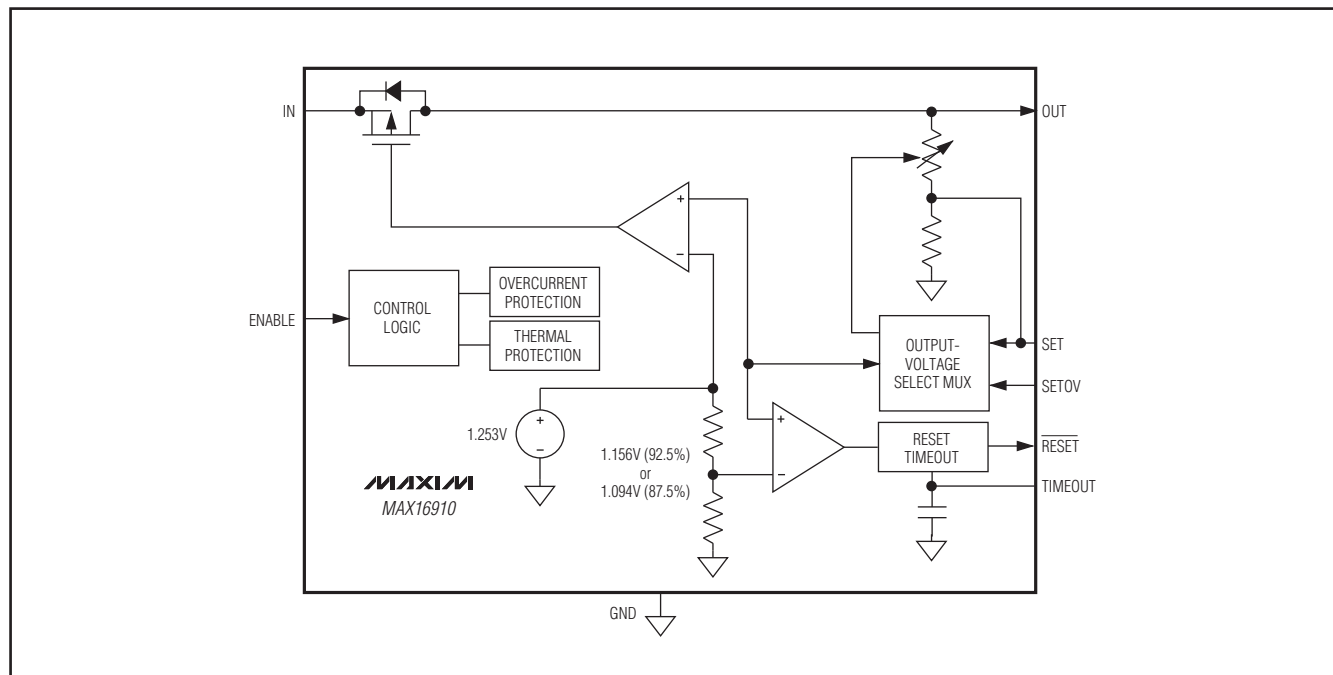

### Detailed Description

The MAX16910 low-quiescent current, high-voltage linear regulator is ideal for use in automotive and battery-operated systems. The device operates from an input voltage of +3.5V to +30V, delivers up to 200mA of load current, and consumes only 20 $\mu$ A of quiescent current at no load. The input is +45V tolerant and is designed to operate under load-dump conditions. The MAX16910 can be user configured as either a fixed output voltage (+3.3V or +5V) or an adjustable output voltage using an external resistive divider.

The MAX16910 features an open-drain, active-low  $\overline{\text{RESET}}$  output with fixed thresholds offered at 92.5% and 87.5% of the output voltage. The  $\overline{\text{RESET}}$  output remains low for a fixed period of 60 $\mu$ s after the output voltage exceeds its threshold. The  $\overline{\text{RESET}}$  delay can be extended with an external capacitor. The MAX16910 includes an enable input short-circuit protection and thermal shutdown.

### Fixed Output-Voltage Mode

The SET and SETOV inputs determine the output mode. For the 5V fixed output-voltage mode (see the 5V fixed output circuit in the *Typical Operating Circuits*), connect SET to GND and SETOV to OUT. For the 3.3V fixed output-voltage mode (see the 3.3V fixed output circuit in the *Typical Operating Circuits*) connect SET to GND and SETOV to GND.

### Adjustable Output-Voltage Mode

For the adjustable output-voltage mode (see the adjustable output circuit in the *Typical Operating Circuits*), connect SET to IN or a voltage > 2.4V and connect SETOV to a resistive divider R1 and R2 between OUT and GND. An output voltage between 1.5V and 11V can be selected using the following equation:

$$V_{\text{OUT}} = V_{\text{SETOV}} \times (1 + R1/R2)$$

where  $V_{\text{SETOV}} = 1.25\text{V}$  and R2 should be less than or equal to 100k $\Omega$ .

# 200mA, Automotive, Ultra-Low Quiescent Current, Linear Regulator

## ENABLE

ENABLE is an active-high, logic-level enable input that turns the device on or off. Drive ENABLE high to turn the device on. An internal 0.65μA pulldown current keeps the MAX16910 in shutdown mode when driven by a three-state driver in high-impedance mode, or an open-drain driver. When in shutdown, the MAX16910 consumes only 1.6μA. ENABLE withstands voltages up to 45V, allowing it to be driven by high-input level voltages or connected to IN for always-on operation.

## Thermal Protection

The MAX16910 features thermal protection. When the junction temperature exceeds +180°C, an internal thermal sensor turns off the pass transistor, and allows the device to cool. The thermal sensor turns on the pass transistor again after the junction temperature cools by 25°C. This results in a cycled output during continuous thermal-overload conditions. Thermal protection protects the MAX16910 in the event of fault conditions. For continuous operation, do not exceed the absolute maximum junction temperature rating of +150°C.

## Output Short-Circuit Current Limit

The MAX16910 features a 330mA current limit. The output can be shorted to GND continuously without damage to the device. During a short circuit, the power dissipated across the pass transistor can quickly heat the device. When the die temperature reaches +180°C, the MAX16910 turns off the pass transistor and automatically restarts after the die temperature has cooled by 25°C.

## RESET Output

The MAX16910 features an active-low, open-drain reset output. Once the monitored output voltage exceeds the reset threshold voltage,  $\overline{\text{RESET}}$  remains low for the reset timeout period and then goes high.  $\overline{\text{RESET}}$  changes from high to low whenever the monitored output voltage drops below the reset threshold voltage.  $\overline{\text{RESET}}$  also asserts low when ENABLE is low and during thermal shutdown.

## Timeout

The MAX16910 features a reset timeout period adjustable input. The internal capacitance produces a 60μs default delay when TIMEOUT is left unconnected. Connect a capacitor from TIMEOUT to GND to set a higher timeout period than default. Use the following formula to determine the reset timeout capacitor:

$$C_{\text{TIMEOUT}} = 0.8 \times I_{\text{TO}} \times T_{\text{TIMEOUT}}$$

where  $C_{\text{TIMEOUT}}$  is in nF,  $I_{\text{TO}}$  is in μA, and  $T_{\text{TIMEOUT}}$  is in ms.

For example, if  $I_{\text{TO}}$  is 1μA,  $C_{\text{TIMEOUT}}$  needs to be 8nF to get a 10ms delay.

## Applications Information

### Output-Capacitor Selection and Regulator Stability

For stable operation over the full temperature range, with fixed 3.3V and 5.0V output voltages, use a low-ESR 4.7μF capacitor. For resistor-programmed output voltages, a 10μF low-ESR ceramic capacitor is recommended for stable operation. Use larger output-capacitor values such as 22μF to reduce noise, improve load-transient response and power-supply rejection. Some ceramic dielectrics exhibit large capacitance and ESR variations with temperature. To improve power-supply rejection and transient response, use a capacitor larger than the minimum 1μF capacitor between IN and GND.

### Available Output-Current Calculation

The MAX16910 provides up to 200mA of continuous output current. The input voltage range extends to 30V. Package power dissipation limits the amount of output current available for a given input/output voltage and ambient temperature. Figure 1 shows the maximum allowable power dissipation for these devices to keep the junction temperature below +150°C. Figure 1 assumes that the exposed metal pad of the MAX16910 is soldered to a 1in<sup>2</sup> of multilayer copper board. Use Figure 1 to determine the allowable package dissipation for a given ambient temperature. Alternately, use the following formulas to calculate the allowable power dissipation  $P_D$ .

For the TDFN-EP package:

$$P_D = \begin{cases} 1.951\text{W} & \text{for } T_A \leq +70^\circ\text{C} \\ 1.951\text{W} - 0.0244 \frac{\text{W}}{^\circ\text{C}} \times (T_A - 70^\circ\text{C}) & \text{for } +70^\circ\text{C} \leq T_A < +125^\circ\text{C} \end{cases}$$

For the SO-EP package:

$$P_D = \begin{cases} 1.861\text{W} & \text{for } T_A \leq +70^\circ\text{C} \\ 1.861\text{W} - 0.0233 \frac{\text{W}}{^\circ\text{C}} \times (T_A - 70^\circ\text{C}) & \text{for } +70^\circ\text{C} \leq T_A < +125^\circ\text{C} \end{cases}$$

## 200mA, Automotive, Ultra-Low Quiescent Current, Linear Regulator

After determining the allowable power dissipation, calculate the maximum allowable output current, without exceeding the +150°C junction temperature, using the following formula:

$$I_{OUT(MAX)} = \frac{P_D}{V_{IN} - V_{OUT}}$$

The above equations do not include the negligible power dissipation from self-heating due to the device ground current.

Example 1 (TDFN-EP Package):

$$T_A = +125^\circ\text{C}, V_{IN} = 16\text{V}, V_{OUT} = 3.3\text{V}$$

Calculate the maximum allowable power dissipation at the given temperature as follows:

$$P_D = 1.951\text{W} - 0.0244 \frac{\text{W}}{^\circ\text{C}} \times (125^\circ\text{C} - 70^\circ\text{C}) = 609\text{mW}$$

And establish the maximum output current:

$$I_{OUT(MAX)} = \frac{609\text{mW}}{16\text{V} - 3.3\text{V}} \cong 48\text{mA}$$

Example 2 (TDFN-EP Package):

$$T_A = +50^\circ\text{C}, V_{IN} = 9\text{V}, V_{OUT} = 5\text{V}$$

Calculate the maximum allowable power dissipation at the given temperature as follows:

$$P_D = 1.951\text{W}$$

Find the maximum output current:

$$I_{OUT(MAX)} = \frac{1.951\text{W}}{9\text{V} - 5\text{V}} = 488\text{mA} \Rightarrow I_{OUT(MAX)} = I_{SC} = 330\text{mA (typ)}$$

In Example 2, the maximum output current is calculated as 488mA. The allowable output current cannot exceed the given internal current limit for the device of 330mA (typ).

### Selecting Timeout Capacitor

The reset timeout period is adjustable to accommodate a variety of microprocessor applications. Adjust the reset timeout period by connecting a capacitor between TIMEOUT and GND.

$$t_{RP} = \frac{1.25 \times C_{TIMEOUT}}{I_{TO}}$$

where  $t_{RP}$  is in ms and  $C_{TIMEOUT}$  is in nF.

Leave TIMEOUT unconnected to select the internally fixed timeout period.  $C_{TIMEOUT}$  must be a low-leakage (< 10nA) type capacitor. Ceramic capacitors are recommended; do not use capacitor values lower than 100pF to avoid the influence of parasitic capacitances.

### Exposed Pad

The MAX16910 package features an exposed thermal pad on its underside that should be used as a heatsink. This pad lowers the package's thermal resistance by providing a direct heat-conduction path from the die to the PCB. Connect the exposed pad and GND to the system ground using a large pad or ground plane, or multiple vias to the ground plane layer.

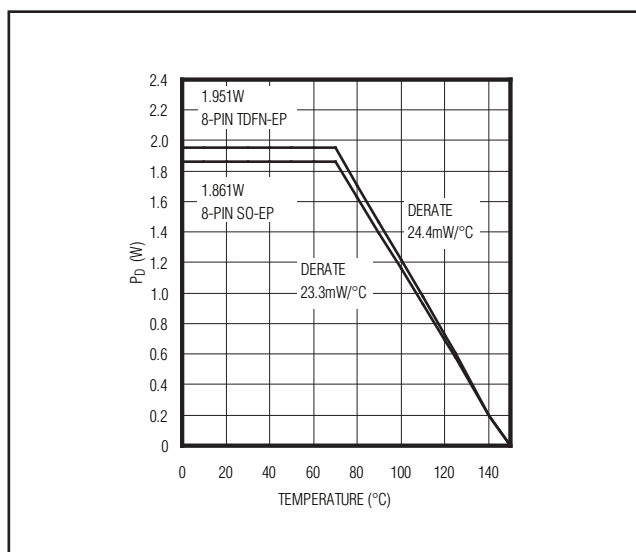

Figure 1. Calculated Maximum Power Dissipation vs. Ambient Temperature

# 200mA, Automotive, Ultra-Low Quiescent Current, Linear Regulator

## Ordering Information/Selector Guide

**MAX16910**

PART	RESET THRESHOLD	PIN-PACKAGE	TOP MARK
MAX16910CATA8/V+	87.5	8 TDFN-EP* (3mm x 3mm)	+BLW
MAX16910CATA9/V+	92.5	8 TDFN-EP* (3mm x 3mm)	+BLV
MAX16910CASA8/V+	87.5	8 SO-EP* (5mm x 4mm)	—
MAX16910CASA9/V+	92.5	8 SO-EP* (5mm x 4mm)	—
MAX16910CATA8+	87.5	8 TDFN-EP* (3mm x 3mm)	+BOW
MAX16910CATA9+	92.5	8 TDFN-EP* (3mm x 3mm)	+BOV
MAX16910CASA8+	87.5	8 SO-EP* (5mm x 4mm)	—
MAX16910CASA9+	92.5	8 SO-EP* (5mm x 4mm)	—

+Denotes a lead(Pb)-free/RoHS-compliant package.

/V denotes an automotive qualified part.

\*EP = Exposed pad.

### Chip Information

PROCESS: BiCMOS DMOS

### Package Information

For the latest package outline information and land patterns, go to [www.maxim-ic.com/packages](http://www.maxim-ic.com/packages). Note that a "+", "#", or "-" in the package code indicates RoHS status only. Package drawings may show a different suffix character, but the drawing pertains to the package regardless of RoHS status.

PACKAGE TYPE	PACKAGE CODE	OUTLINE NO.	LAND PATTERN NO.
8 TDFN-EP	T833+2	<a href="#">21-0137</a>	<a href="#">90-0059</a>
8 SO-EP	S8E+12	<a href="#">21-0111</a>	<a href="#">90-0150</a>

# 200mA, Automotive, Ultra-Low Quiescent Current, Linear Regulator

## Revision History

REVISION NUMBER	REVISION DATE	DESCRIPTION	PAGES CHANGED
0	7/09	Initial release	—
1	10/10	Added a junction temperature range of -40°C to +150°C in the <i>Features</i> section, updated <i>Electrical Characteristics</i> table with +150°C junction temperature in “5V Output Voltage,” “3.3V Output Voltage,” and “Dropout Voltage” parameters, added new Note 4, updated TOC 10 and Figure 1	1, 4, 5, 6, 8, 13
2	7/11	Removed the typ value from the “Dropout Voltage” I <sub>LOAD</sub> = 50mA parameter in the <i>Electrical Characteristics</i> table	4
3	4/12	Added consumer-grade products to data sheet	1,14

**MAX16910**

Maxim cannot assume responsibility for use of any circuitry other than circuitry entirely embodied in a Maxim product. No circuit patent licenses are implied. Maxim reserves the right to change the circuitry and specifications without notice at any time. The parametric values (min and max limits) shown in the *Electrical Characteristics* table are guaranteed. Other parametric values quoted in this data sheet are provided for guidance.

Maxim Integrated Products, 120 San Gabriel Drive, Sunnyvale, CA 94086 408-737-7600 \_\_\_\_\_ 15