

**PLEASE CHECK WWW.MOLEX.COM FOR LATEST PART INFORMATION**

**Part Number:** [0459850453](#)  
**Status:** **Active**  
**Overview:** [extreme\\_lphpower](#)  
**Description:** 1.27mm (.050") Pitch, EXTreme LPHPower™ Plug with Guides and Pegs, Right Angle, 28 Signal Contacts, Select Gold (Au) Plating, for 1.57mm (.061") Thick PC Board

**Documents:**

[3D Model](#) [Product Specification PS-45984-001 \(PDF\)](#)  
[Drawing \(PDF\)](#) [RoHS Certificate of Compliance \(PDF\)](#)

**Agency Certification**

CSA	LR19980
TUV	30683046
UL	E29179

**General**

Product Family	PCB Headers
Series	<a href="#">45985</a>
Application	Board-to-Board
Overview	<a href="#">extreme_lphpower</a>
Product Name	EXTreme PowerPlus™

**Physical**

Breakaway	No
Circuits (Loaded)	28
Circuits (maximum)	28
Circuits Detail	28 Signal
Color - Resin	Black
Durability (mating cycles max)	250
First Mate / Last Break	No
Flammability	94V-0
Glow-Wire Compliant	No
Guide to Mating Part	Yes
Keying to Mating Part	None
Lock to Mating Part	No
Material - Metal	Copper Alloy
Material - Plating Mating	Gold over Nickel
Material - Plating Termination	Tin
Material - Resin	High Temperature Thermoplastic
Number of Rows	2
Orientation	Right Angle
PC Tail Length (in)	0.114 In
PC Tail Length (mm)	2.90 mm
PCB Locator	Yes
PCB Retention	None
PCB Thickness Recommended (in)	0.061 In
PCB Thickness Recommended (mm)	1.57 mm
Packaging Type	Tray
Pitch - Mating Interface (in)	0.050 In
Pitch - Mating Interface (mm)	1.27 mm
Plating min: Mating (µin)	30
Plating min: Mating (µm)	0.75
Plating min: Termination (µin)	150, 50
Plating min: Termination (µm)	1.25, 3.75
Polarized to Mating Part	Yes
Polarized to PCB	Yes

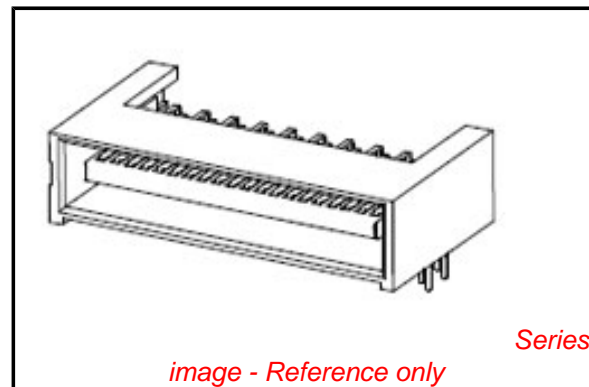

image - Reference only

**EU RoHS**

**ELV and RoHS Compliant**  
**REACH SVHC**  
 Not Reviewed  
**Halogen-Free Status**  
 Not Reviewed

**China RoHS**



**Need more information on product environmental compliance?**

Email [productcompliance@molex.com](mailto:productcompliance@molex.com)  
 For a multiple part number RoHS Certificate of Compliance, [click here](#)

Please visit the [Contact Us](#) section for any non-product compliance questions.

**Search Parts in this Series**

[45985Series](#)

**Mates With**

[45984](#) EXTreme LPHPower™ PCB Receptacles

Shrouded	Fully
Stackable	No
Surface Mount Compatible (SMC)	Yes
Temperature Range - Operating	-40°C to +105°C
Termination Interface: Style	Through Hole

### **Electrical**

Current - Maximum per Contact	1A
Voltage - Maximum	250V AC (RMS)/DC

### **Solder Process Data**

Duration at Max. Process Temperature (seconds)	20
Lead-free Process Capability	Wave Capable (TH only)
Max. Cycles at Max. Process Temperature	3
Process Temperature max. C	260

### **Material Info**

### **Reference - Drawing Numbers**

Packaging Specification	PK-45984-001
Product Specification	PS-45984-001
Sales Drawing	SD-45985-483

This document was generated on 06/07/2010

**PLEASE CHECK [WWW.MOLEX.COM](http://WWW.MOLEX.COM) FOR LATEST PART INFORMATION**

10 9 8 7 6 5 4 3 2 1

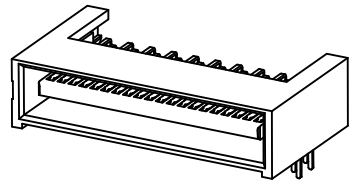
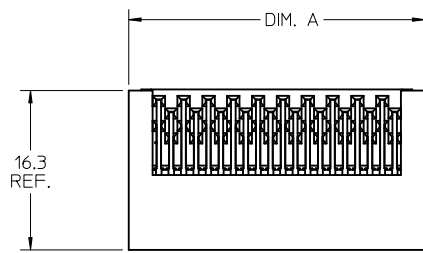

NO OF SIGNAL	MATERIAL NUMBER	DIM A	DIM P	PCB THK
12	45985-0111	12.5	4.50	3.18
16	45985-0121	15.0		
20	45985-0131	17.6		
24	45985-0141	20.1		
28	45985-0151	22.6		
32	45985-0161	25.2	3.60	2.36
36	45985-0171	27.7		
40	45985-0181	30.3		
12	45985-0112	12.5		
16	45985-0122	15.0		
20	45985-0132	17.6	2.90	1.57
24	45985-0142	20.1		
28	45985-0152	22.6		
32	45985-0162	25.2		
36	45985-0172	27.7		
40	45985-0182	30.3	2.90	1.57
12	45985-0113	12.5		
16	45985-0123	15.0		
20	45985-0133	17.6		
24	45985-0143	20.1		
28	45985-0153	22.6	2.90	1.57
32	45985-0163	25.2		
36	45985-0173	27.7		
40	45985-0183	30.3		

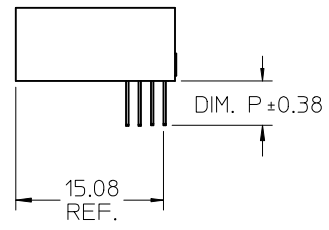
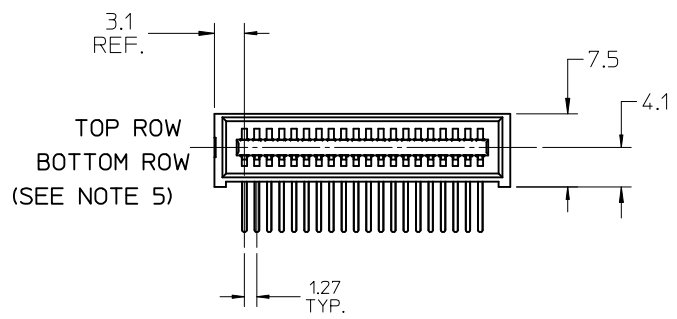

NOTES:

- MATERIAL: HOUSING - 30 % GLASS FILLED LCP UL94V-0, COLOR: BLACK  
TERMINALS: COPPER ALLOY
- PLATING: 0.76 MICROMETER / (30 M.I.) MIN. SELECT GOLD  
3.81 MICROMETER / (150 M.I.) MIN SELECT TIN, BOTH OVER  
1.27 MICROMETER / (50 M.I.) MIN NICKEL OVERALL.
- PRODUCT SPECIFICATION: PS-45984-001.
- PACKAGING SPECIFICATION: PK-45984-001.
- SEE SHEET 5 FOR CIRCUIT IDENTIFICATION.
- PARTS ARE RoHS COMPLIANT.
- MATES WITH 45984, 46113 SERIES RECEPTACLE.

REVISED EC NO: UCP2010-1874 DRW:MBANDURA 2010/02/01 CHKD:MBANDURA 2010/03/10 APPR:APATEL 2010/03/10	DESCRIPTION B	QUALITY SYMBOLS	GENERAL TOLERANCES (UNLESS SPECIFIED)		DIMENSION STYLE MM ONLY		SCALE 1:1	DESIGN UNITS METRIC	THIRD ANGLE PROJECTION	
		▽=0 ▽=0	mm      INCH 4 PLACES ± --- ± --- 3 PLACES ± --- ± --- 2 PLACES ± 0.25 ± --- 1 PLACE ± --- ± ---	DRAWN BY BANDURA	DATE 5/1/2006	TITLE LPH PLUG ASSEMBLY SIGNAL CONNECTOR				
		ANGULAR ±1/2°		CHECKED BY BANDURA	DATE 5/1/2006	MOLEX INCORPORATED SD-45985-483				
		DRAFT WHERE APPLICABLE MUST REMAIN WITHIN DIMENSIONS		APPROVED BY PATEL	DATE 5/5/2006			MATERIAL NO. SEE CHART	DOCUMENT NO. SD-45985-483	
		THIS DRAWING CONTAINS INFORMATION THAT IS PROPRIETARY TO MOLEX INCORPORATED AND SHOULD NOT BE USED WITHOUT WRITTEN PERMISSION		SHEET NO. 1 OF 5						

9 8 7 6 5 4 3 2 1

10 9 8 7 6 5 4 3 2 1

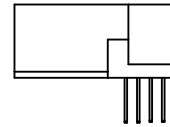
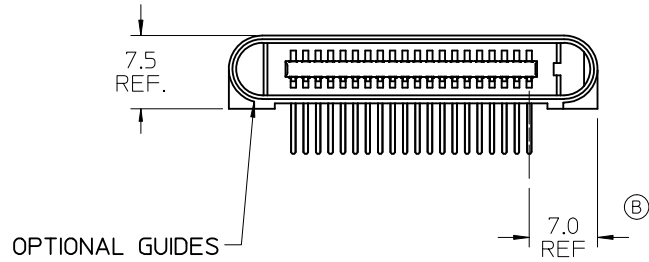
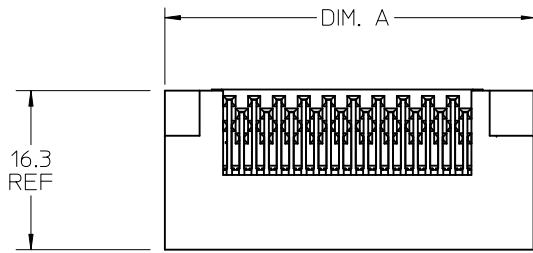

NO OF SIGNAL	MATERIAL NUMBER	DIM A	DIM P	PCB THK
12	45985-0211	19.9	4.50	3.18
16	45985-0221	22.5		
20	45985-0231	25.0		
24	45985-0241	27.6		
28	45985-0251	30.1		
32	45985-0261	32.6		
36	45985-0271	35.2	3.60	2.36
40	45985-0281	37.7		
12	45985-0212	19.9		
16	45985-0222	22.5		
20	45985-0232	25.0		
24	45985-0242	27.6		
28	45985-0252	30.1	2.90	1.57
32	45985-0262	32.6		
36	45985-0272	35.2		
40	45985-0282	37.7		
12	45985-0213	19.9		
16	45985-0223	22.5		
20	45985-0233	25.0	2.90	1.57
24	45985-0243	27.6		
28	45985-0253	30.1		
32	45985-0263	32.6		
36	45985-0273	35.2	2.90	1.57
40	45985-0283	37.7		

<b>REVISED</b> EC NO: UCP2010-1874 DRWN:MBANDURA 2010/02/01 CHKD:MBANDURA 2010/03/10 APPR:APATEL 2010/03/10	DESCRIPTION REV	QUALITY SYMBOLS ▽=0 ▽7=0	GENERAL TOLERANCES (UNLESS SPECIFIED)		DIMENSION STYLE <b>MM ONLY</b>		SCALE <b>2:1</b>	DESIGN UNITS <b>METRIC</b>	THIRD ANGLE PROJECTION		
			mm      INCH	DRAWN BY BANDURA	DATE 5/1/2006	TITLE <b>LPH PLUG ASSEMBLY SIGNAL CONNECTOR</b>					
		4 PLACES ± --- ± --- 3 PLACES ± --- ± --- 2 PLACES ± 0.25 ± --- 1 PLACE ± --- ± ---	CHECKED BY BANDURA	DATE 5/1/2006							
			ANGULAR ±1/2°	APPROVED BY PATEL	DATE 5/5/2006	MOLEX INCORPORATED					
DRAFT WHERE APPLICABLE MUST REMAIN WITHIN DIMENSIONS		MATERIAL NO. SEE CHART	DOCUMENT NO. SD-45985-483	SHEET NO. 2 OF 5							

9 8 7 6 5 4 3 2 1

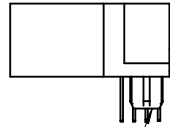
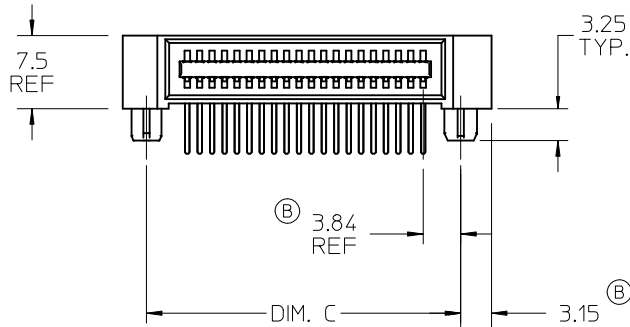
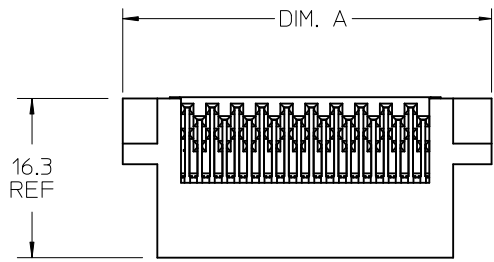

NO OF SIGNAL	MATERIAL NUMBER	DIM A	DIM C	DIM P	PCB THK
12	45985-0311	19.9	14.37	4.50	3.18
16	45985-0321	22.5	16.91		
20	45985-0331	25.0	19.45		
24	45985-0341	27.6	21.99		
28	45985-0351	30.1	24.53		
32	45985-0361	32.6	27.07		
36	45985-0371	35.2	29.61	3.60	2.36
40	45985-0381	37.7	32.15		
12	45985-0312	19.9	14.37		
16	45985-0322	22.5	16.91		
20	45985-0332	25.0	19.45		
24	45985-0342	27.6	21.99		
28	45985-0352	30.1	24.53	2.90	1.57
32	45985-0362	32.6	27.07		
36	45985-0372	35.2	29.61		
40	45985-0382	37.7	32.15		
12	45985-0313	19.9	14.37		
16	45985-0323	22.5	16.91		
20	45985-0333	25.0	19.45		
24	45985-0343	27.6	21.99		
28	45985-0353	30.1	24.53		
32	45985-0363	32.6	27.07		
36	45985-0373	35.2	29.61		
40	45985-0383	37.7	32.15		

<b>REVISED</b> EC NO: UCP2010-1874 DRWN:MBANDURA 2010/02/01 CHKD:MBANDURA 2010/03/10 APPR:APATEL 2010/03/10	DESCRIPTION LPH PLUG ASSEMBLY	QUALITY SYMBOLS	GENERAL TOLERANCES (UNLESS SPECIFIED)	DIMENSION STYLE <b>MM ONLY</b>		SCALE <b>2:1</b>	DESIGN UNITS <b>METRIC</b>	THIRD ANGLE PROJECTION																											
		$\nabla=0$ $\nabla 7=0$	<table border="1"> <thead> <tr> <th></th> <th>mm</th> <th>INCH</th> </tr> </thead> <tbody> <tr> <td>4 PLACES</td> <td>± ---</td> <td>± ---</td> </tr> <tr> <td>3 PLACES</td> <td>± ---</td> <td>± ---</td> </tr> <tr> <td>2 PLACES</td> <td>± 0.25</td> <td>± ---</td> </tr> <tr> <td>1 PLACE</td> <td>± ---</td> <td>± ---</td> </tr> </tbody> </table>		mm	INCH	4 PLACES	± ---	± ---	3 PLACES	± ---	± ---	2 PLACES	± 0.25	± ---	1 PLACE	± ---	± ---	<table border="1"> <thead> <tr> <th>DRAWN BY</th> <th>DATE</th> </tr> </thead> <tbody> <tr> <td>BANDURA</td> <td>5/1/2006</td> </tr> <tr> <th>CHECKED BY</th> <th>DATE</th> </tr> <tr> <td>BANDURA</td> <td>5/1/2006</td> </tr> <tr> <th>APPROVED BY</th> <th>DATE</th> </tr> <tr> <td>PATEL</td> <td>5/5/2006</td> </tr> </tbody> </table>	DRAWN BY	DATE	BANDURA	5/1/2006	CHECKED BY	DATE	BANDURA	5/1/2006	APPROVED BY	DATE	PATEL	5/5/2006	<b>LPH PLUG ASSEMBLY SIGNAL CONNECTOR</b>			
			mm	INCH																															
		4 PLACES	± ---	± ---																															
3 PLACES	± ---	± ---																																	
2 PLACES	± 0.25	± ---																																	
1 PLACE	± ---	± ---																																	
DRAWN BY	DATE																																		
BANDURA	5/1/2006																																		
CHECKED BY	DATE																																		
BANDURA	5/1/2006																																		
APPROVED BY	DATE																																		
PATEL	5/5/2006																																		
ANGULAR ±1/2°		<b>MOLEX INCORPORATED</b>																																	
DRAFT WHERE APPLICABLE MUST REMAIN WITHIN DIMENSIONS		<b>SEE CHART</b>		DOCUMENT NO. <b>SD-45985-483</b>		SHEET NO. <b>3 OF 5</b>																													

10 9 8 7 6 5 4 3 2 1

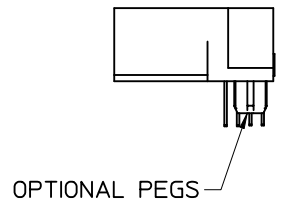
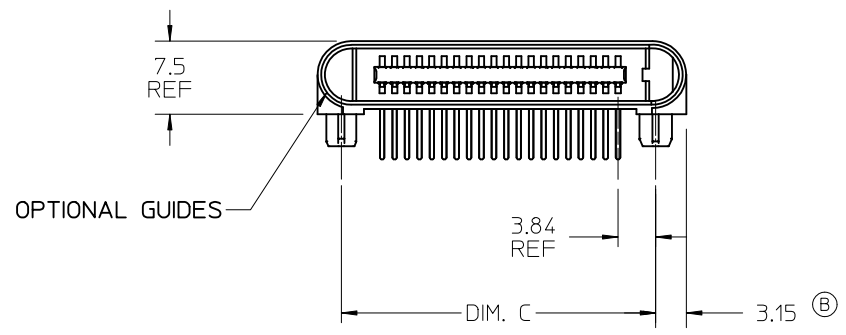
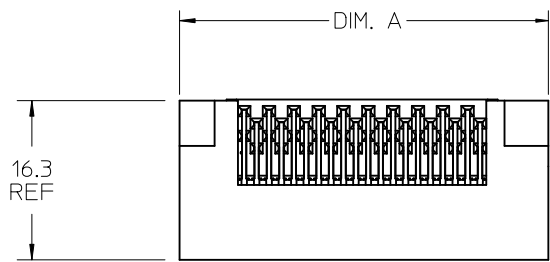

NO OF SIGNAL	MATERIAL NUMBER	DIM A	DIM C	DIM P	PCB THK
12	45985-0411	19.9	14.37	4.50	3.18
16	45985-0421	22.5	16.91		
20	45985-0431	25.0	19.45		
24	45985-0441	27.6	21.99		
28	45985-0451	30.1	24.53		
32	45985-0461	32.6	27.07		
36	45985-0471	35.2	29.61	3.60	2.36
40	45985-0481	37.7	32.15		
12	45985-0412	19.9	14.37		
16	45985-0422	22.5	16.91		
20	45985-0432	25.0	19.45		
24	45985-0442	27.6	21.99		
28	45985-0452	30.1	24.53	2.90	1.57
32	45985-0462	32.6	27.07		
36	45985-0472	35.2	29.61		
40	45985-0482	37.7	32.15		
12	45985-0413	19.9	14.37		
16	45985-0423	22.5	16.91		
20	45985-0433	25.0	19.45	2.90	1.57
24	45985-0443	27.6	21.99		
28	45985-0453	30.1	24.53		
32	45985-0463	32.6	27.07		
36	45985-0473	35.2	29.61		
40	45985-0483	37.7	32.15		

<b>REVISED</b> EC NO: UCP2010-1874 DRWN:MBANDURA 2010/02/01 CHKD:MBANDURA 2010/03/10 APPR:APATEL 2010/03/10 B	QUALITY SYMBOLS ▽=0 ▽7=0	GENERAL TOLERANCES (UNLESS SPECIFIED)		DIMENSION STYLE <b>MM ONLY</b>		SCALE <b>1:1</b>	DESIGN UNITS <b>METRIC</b>	THIRD ANGLE PROJECTION			
		4 PLACES ± --- ± ---	3 PLACES ± --- ± ---	2 PLACES ± 0.25 ± ---	1 PLACE ± --- ± ---	DRAWN BY BANDURA	DATE 5/1/2006	TITLE <b>LPH PLUG ASSEMBLY SIGNAL CONNECTOR</b>			
		ANGULAR ±1/2°				CHECKED BY BANDURA	DATE 5/1/2006				
		DRAFT WHERE APPLICABLE MUST REMAIN WITHIN DIMENSIONS				MATERIAL NO. SEE CHART	APPROVED BY PATEL	DATE 5/5/2006	Molex <b>MOLEX INCORPORATED</b>		SHEET NO. 4 OF 5

9 8 7 6 5 4 3 2 1

10 9 8 7 6 5 4 3 2 1

NO OF SIGNAL	DIM C
12	14.37
16	16.91
20	19.45
24	21.99
28	24.53
32	27.07
36	29.61
40	32.15

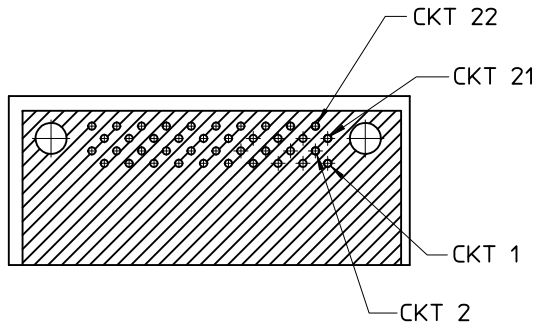
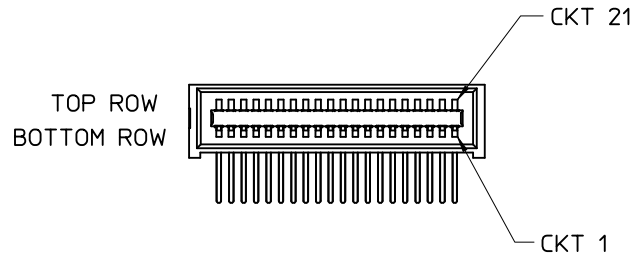

CIRCUIT IDENTIFICATION  
(40 CIRCUIT SHOWN)

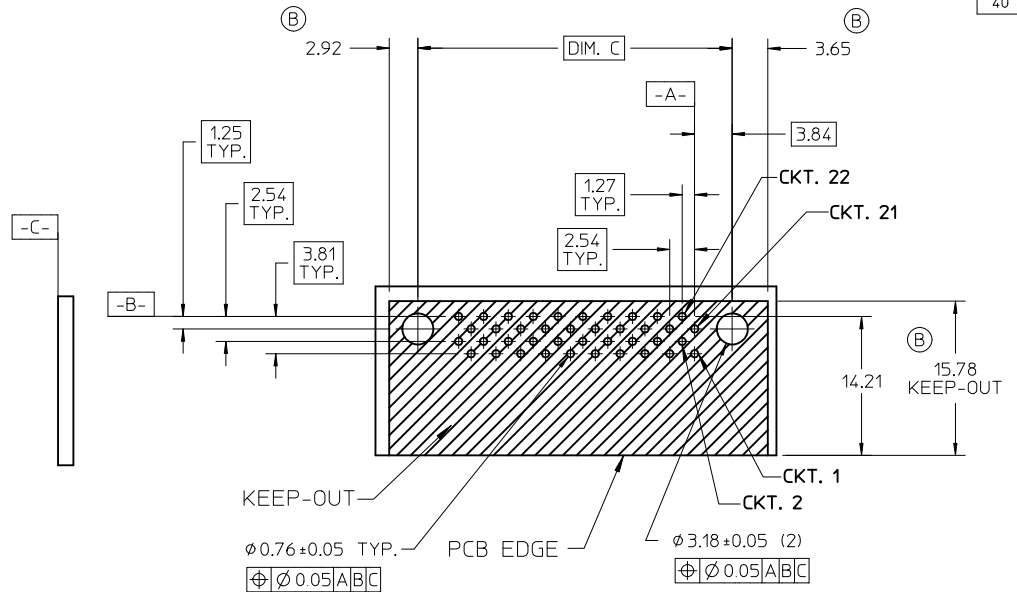

RECOMMENDED PCB LAYOUT  
SHOWN FROM COMPONENT SIDE

REVISED EC NO: UCP2010-1874 DRWN:MBANDURA 2010/02/01 CHKD:MBANDURA 2010/03/10 APPR:APATEL 2010/03/10 REV B	DESCRIPTION LPH PLUG ASSEMBLY SIGNAL CONNECTOR	QUALITY SYMBOLS	GENERAL TOLERANCES (UNLESS SPECIFIED)	DIMENSION STYLE	SCALE	DESIGN UNITS	THIRD ANGLE PROJECTION
		$\nabla=0$ $\nabla 7=0$	mm INCH 4 PLACES $\pm$ --- $\pm$ --- 3 PLACES $\pm$ --- $\pm$ --- 2 PLACES $\pm 0.25$ $\pm$ --- 1 PLACE $\pm$ --- $\pm$ --- ANGULAR $\pm 1/2^\circ$	MM ONLY	1:1	METRIC	DRAWN BY BANDURA 5/1/2006 CHECKED BY BANDURA 5/1/2006 APPROVED BY PATEL 5/5/2006
		DRAFT WHERE APPLICABLE MUST REMAIN WITHIN DIMENSIONS	SEE CHART	MOLEX INCORPORATED DOCUMENT NO. SD-45985-483	SHEET NO. 5 OF 5		
		THIS DRAWING CONTAINS INFORMATION THAT IS PROPRIETARY TO MOLEX INCORPORATED AND SHOULD NOT BE USED WITHOUT WRITTEN PERMISSION					

9 8 7 6 5 4 3 2 1