

GBJ25A THRU GBJ25M

GLASS PASSIVATED SINGLE PHASE BRIDGE RECTIFIERS

Reverse Voltage - 50 to 1000 V

Forward Current - 25 A

Features

- Thin Single In-Line package
- Ideal for printed circuit boards
- Glass passivated chip junction
- Plastic package has Underwriters Laboratory Flammability Classification 94V-0

Mechanical Data

- Case: GBJ
- Terminals: Plated leads solderable per MIL-STD-750 Method 2026
- Polarity: As marked on body

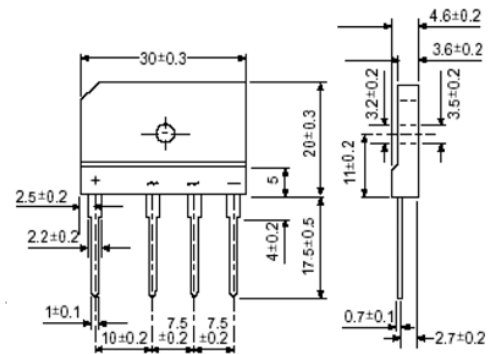

Package outline dimensions in millimeters

Maximum Ratings and Electrical Characteristics

Ratings at 25 °C ambient temperature unless otherwise specified.

Parameter	Symbols	GBJ25A	GBJ25B	GBJ25D	GBJ25G	GBJ25J	GBJ25K	GBJ25M	Units
Maximum Repetitive Peak Reverse Voltage	V_{RRM}	50	100	200	400	600	800	1000	V
Maximum RMS Voltage	V_{RMS}	35	70	140	280	420	560	700	V
Maximum DC Blocking Voltage	V_{DC}	50	100	200	400	600	800	1000	V
Maximum Average Forward Rectified Output Current at $T_C = 98\text{ }^\circ\text{C}$	$I_{F(AV)}$	25							A
Peak Forward Surge Current, 8.3 ms Single Half Sine Wave Superimposed on Rated Load (JEDEC Method)	I_{FSM}	350							A
Maximum Forward Voltage per Leg at 12.5 A	V_F	1							V
Maximum DC Reverse Current at Rated DC Blocking Voltage	$T_A = 25\text{ }^\circ\text{C}$	5							μA
	$T_A = 125\text{ }^\circ\text{C}$	250							
Operating Junction and Storage Temperature Range	T_j, T_{stg}	- 55 to + 150							$^\circ\text{C}$

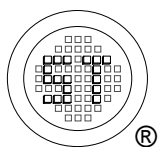

SEMTECH ELECTRONICS LTD.

(Subsidiary of Sino-Tech International Holdings Limited, a company listed on the Hong Kong Stock Exchange, Stock Code: 724)

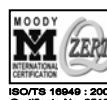

ISO/TS 16949 : 2002
Certificate No. 05103

ISO 14001:2004
Certificate No. 7116

ISO 9001:2000
Certificate No. 0506098

BS-OHSAS 18001: 2007
Certificate No. 7116

IECQ QC 080000
Certificate No. 7116

GBJ25A THRU GBJ25M

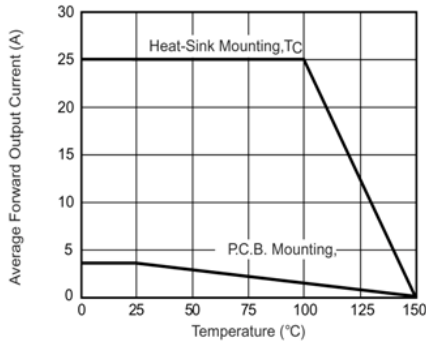

Figure 1. Derating Curve Output Rectified Current

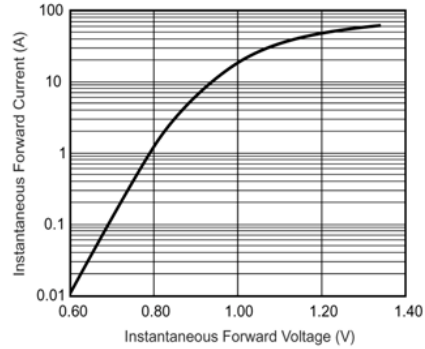

Figure 3. Typical Forward Characteristics Per Leg

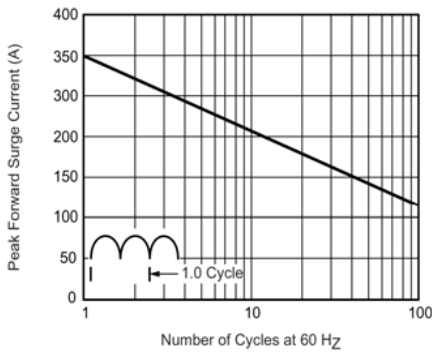

Figure 2. Maximum Non-Repetitive Peak Forward Surge Current Per Leg

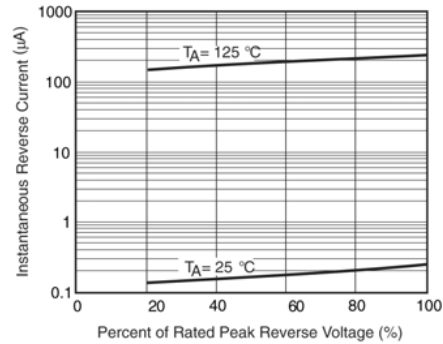

Figure 4. Typical Reverse Characteristics Per Leg

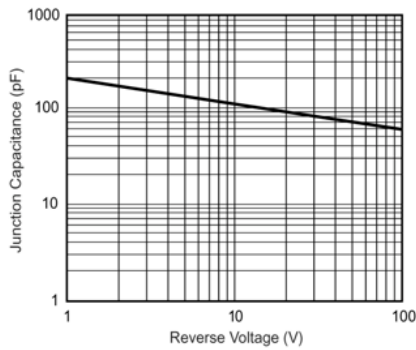

Figure 5. Typical Junction Capacitance Per Leg

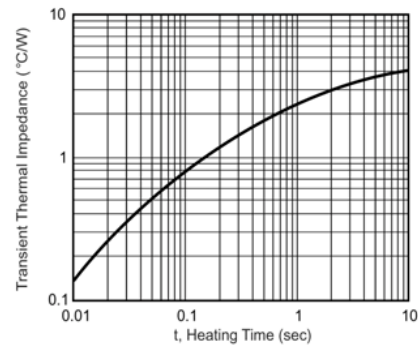
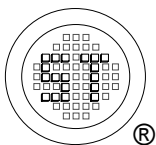

Figure 6. Typical Transient Thermal Impedance



SEMTECH ELECTRONICS LTD.

(Subsidiary of Sino-Tech International Holdings Limited, a company listed on the Hong Kong Stock Exchange, Stock Code: 724)

