

## GaAs MMIC FUNDAMENTAL MIXER, 24 - 40 GHz

### Typical Applications

The HMC560 is ideal for:

- Test Equipment & Sensors
- Microwave Point-to-Point Radios
- Point-to-Multi-Point Radios
- Military & Space

### Features

- Wide IF Bandwidth: DC - 18 GHz
- Input IP3: +21 dBm
- High LO/Rf Isolation: 35 dB
- Passive Double Balanced Topology
- Compact Size: 1.15 x 0.78 x 0.1 mm

### Functional Diagram

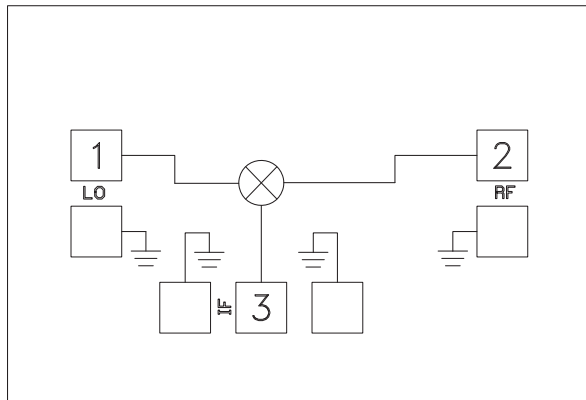

### General Description

The HMC560 chip is a miniature passive double balanced mixer which is fabricated in a GaAs MESFET process, and can be used as an upconverter or downconverter from 24-40 GHz in a small chip area. The wide bandwidth allows this device to be used across multiple radio bands with a common platform. Excellent isolations are provided by on-chip baluns, and the chip requires no external components and no DC bias. Measurements were made with the chip mounted and ribbon bonded into in a 50-ohm microstrip test fixture. Measured data includes the parasitic effects of the assembly. RF connections to the chip were made with 0.076mm (3-mil) ribbon bond with minimal length <0.31mm (<12 mil).

### Electrical Specifications, $T_A = +25^\circ \text{C}$ , $IF = 1\text{GHz}$ , $LO = +13 \text{dBm}^*$

Parameter	Min.	Typ.	Max.	Min.	Typ.	Max.	Units
Frequency Range, RF & LO	24 - 36		36 - 40				GHz
Frequency Range, IF	DC - 18		DC - 18				GHz
Conversion Loss		8	10		10	13	dB
Noise Figure (SSB)		8	10		10	13	dB
LO to RF Isolation	27	35		20	35		dB
LO to IF Isolation	29	32		18			dB
RF to IF Isolation	17	22		21	33		dB
IP3 (Input)		19			21		dBm
IP2 (Input)		50			50		dBm
1 dB Compression (Input)		13			15		dBm

\* Unless otherwise noted, all measurements performed as downconverter

**GaAs MMIC FUNDAMENTAL  
MIXER, 24 - 40 GHz**

**Conversion Gain vs.  
Temperature @ LO = +13 dBm**

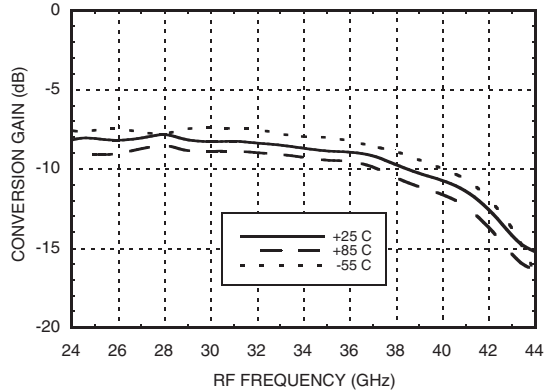

**Isolation @ LO = +13 dBm**

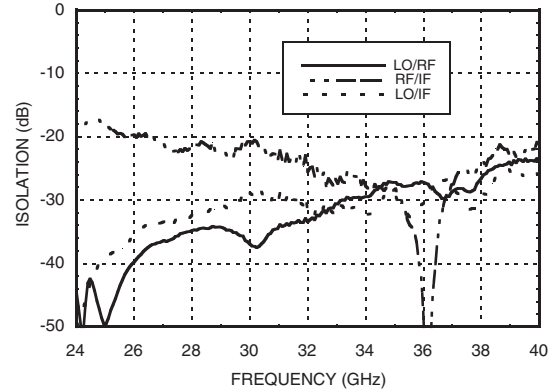

**Conversion Gain vs. LO Drive**

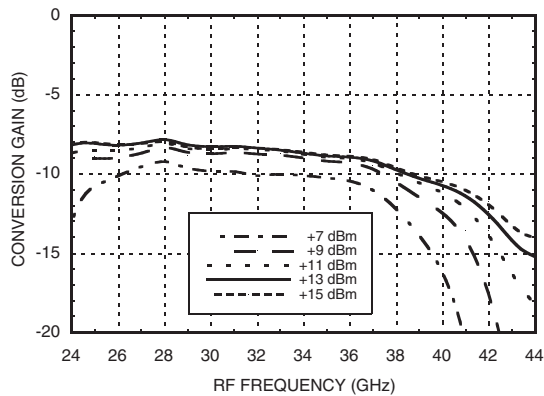

**IF Bandwidth @ LO = +13 dBm**

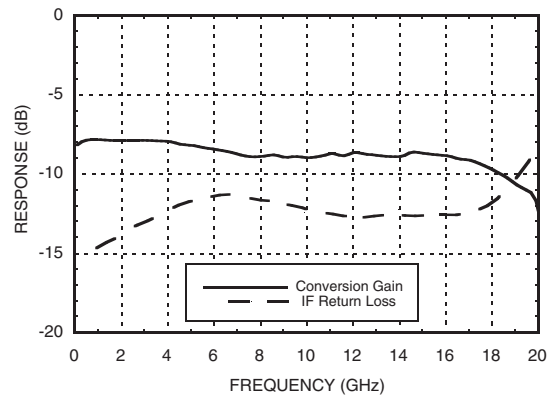

**Upconverter Performance  
Conversion Gain @ LO = +13 dBm**

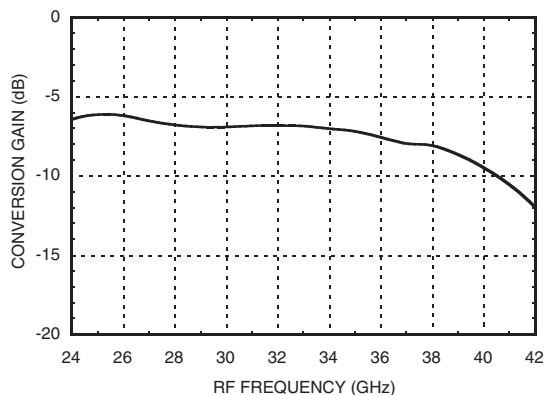

**Return Loss @ LO = +13 dBm**

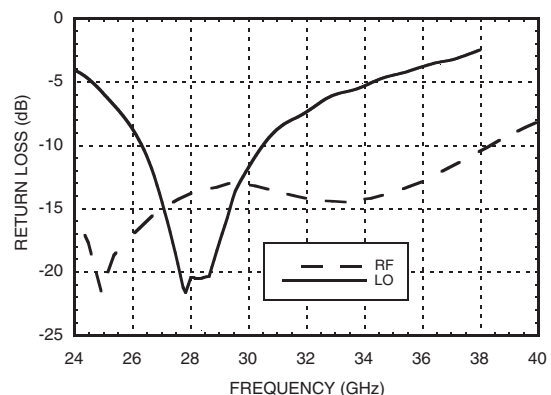

**GaAs MMIC FUNDAMENTAL MIXER, 24 - 40 GHz**

**Input IP3 vs. LO Drive \***

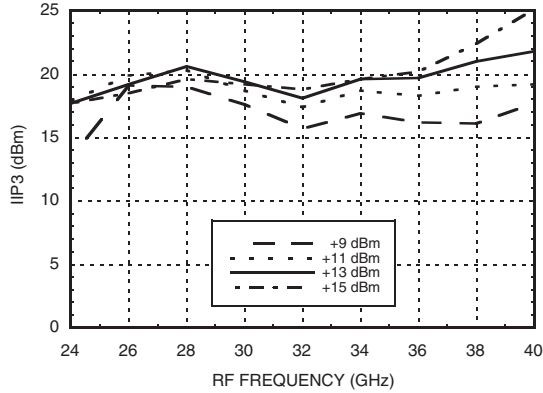

**Input IP3 vs. Temperature @ LO = +13 dBm \***

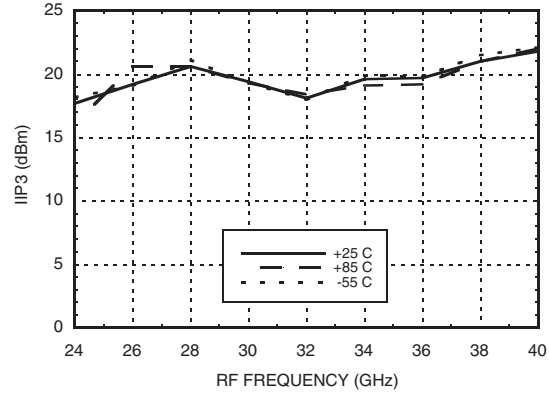

**Input IP2 vs. LO Drive \***

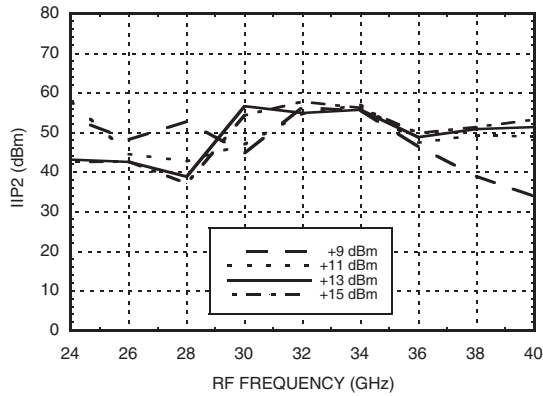

**Input IP2 vs. Temperature @ LO = +13 dBm \***

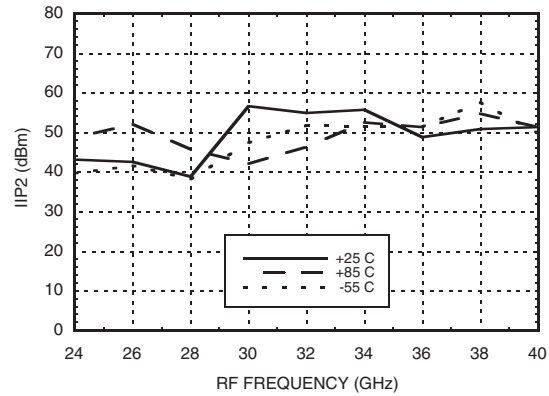

**Upconverter Performance Input IP3 @ LO = +13 dBm**

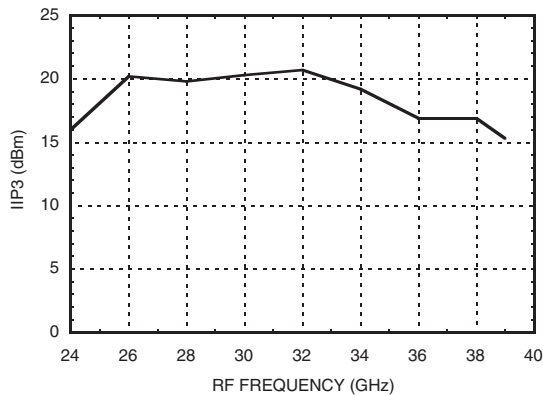

**Input P1dB vs. Temperature @ LO = +13 dBm**

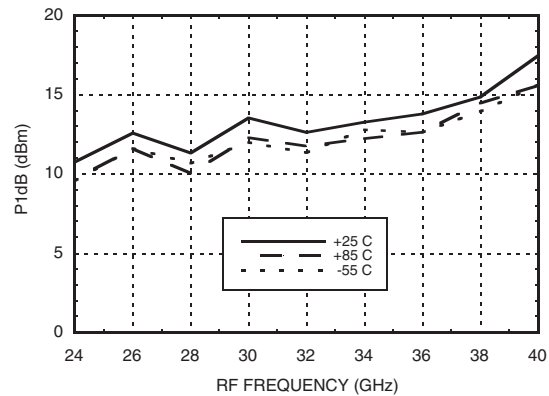

\* Two-tone input power = -10 dBm each tone, 1 MHz spacing.

**GaAs MMIC FUNDAMENTAL  
MIXER, 24 - 40 GHz**

**Absolute Maximum Ratings**

RF / IF Input	+25 dBm
LO Drive	+23 dBm
IF DC Current	±2 mA
Channel Temperature	150 °C/W
Continuous P <sub>diss</sub> (T= 85 °C ) (derate 14.79 mW/ °C above 85 °C)	0.961 W
Thermal Resistance (R <sub>TH</sub> ) (channel to die bottom)	67.6 °C/W
Storage Temperature	-65 to +150 °C
Operating Temperature	-55 to +85 °C

**MxN Spurious Outputs  
as a Down Converter**

mRF	nLO			
	0	1	2	3
0	xx	-9	-13	
1	-10	0	-40	
2	-68	-55	-55	-66
3		-82	-84	-66

RF = 24 GHz @ -10 dBm  
LO = 25 GHz @ +13 dBm  
All values in dBc below IF output power level.



**ELECTROSTATIC SENSITIVE DEVICE  
OBSERVE HANDLING PRECAUTIONS**

**Outline Drawing**

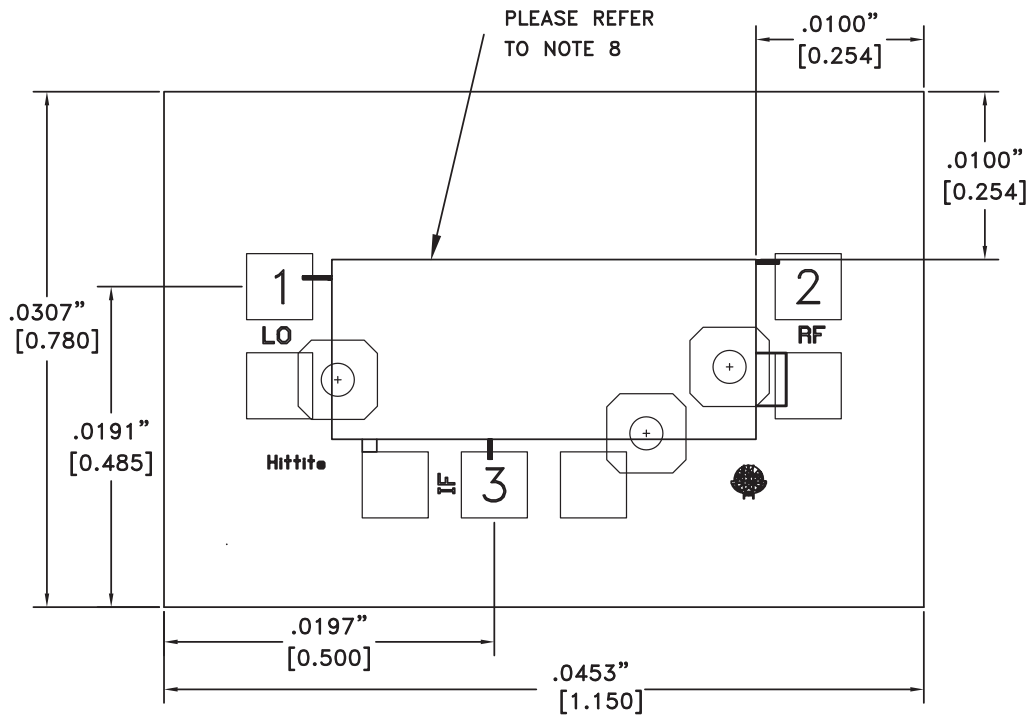

**Die Packaging Information [1]**

Standard	Alternate
WP-7 (Waffle Pack)	[2]

[1] Refer to the "Packaging Information" section for die packaging dimensions.

[2] For alternate packaging information contact Hittite Microwave Corporation.

**NOTES:**

1. ALL DIMENSIONS ARE IN INCHES [MM].
2. DIE THICKNESS IS .004".
3. TYPICAL BOND PAD IS .004" SQUARE.
4. BACKSIDE METALLIZATION: GOLD.
5. BOND PAD METALLIZATION: GOLD.
6. BACKSIDE METAL IS GROUND.
7. CONNECTION NOT REQUIRED FOR UNLABELED BOND PADS.
8. THIS DIE IS DESIGNED FOR PICK-UP WITH VACUUM (EDGE) COLLET TOOLS. TO PRECLUDE THE RISK OF PERMANENT DAMAGE, NO CONTACT TO THE DIE SURFACE IS ALLOWED WITHIN THIS RECTANGULAR AREA.
9. OVERALL DIE SIZE IS ±0.002"

For price, delivery, and to place orders, please contact Hittite Microwave Corporation:  
20 Alpha Road, Chelmsford, MA 01824 Phone: 978-250-3343 Fax: 978-250-3373  
Order On-line at [www.hittite.com](http://www.hittite.com)

**GaAs MMIC FUNDAMENTAL MIXER, 24 - 40 GHz**

**Pad Descriptions**

Pad Number	Function	Description	Interface Schematic
1	LO	This pad is DC coupled and matched to 50 Ohms.	
2	RF	This pad is DC coupled and matched to 50 Ohms.	
3	IF	This pad is DC coupled. For applications not requiring operation to DC, this port should be DC blocked externally using a series capacitor whose value has been chosen to pass the necessary IF frequency range. For operation to DC, this pad must not source/sink more than 2mA of current or die non-function and possible die failure will result.	
	GND	The backside of the die must be connected to RF/DC ground.	

**Assembly Drawing**

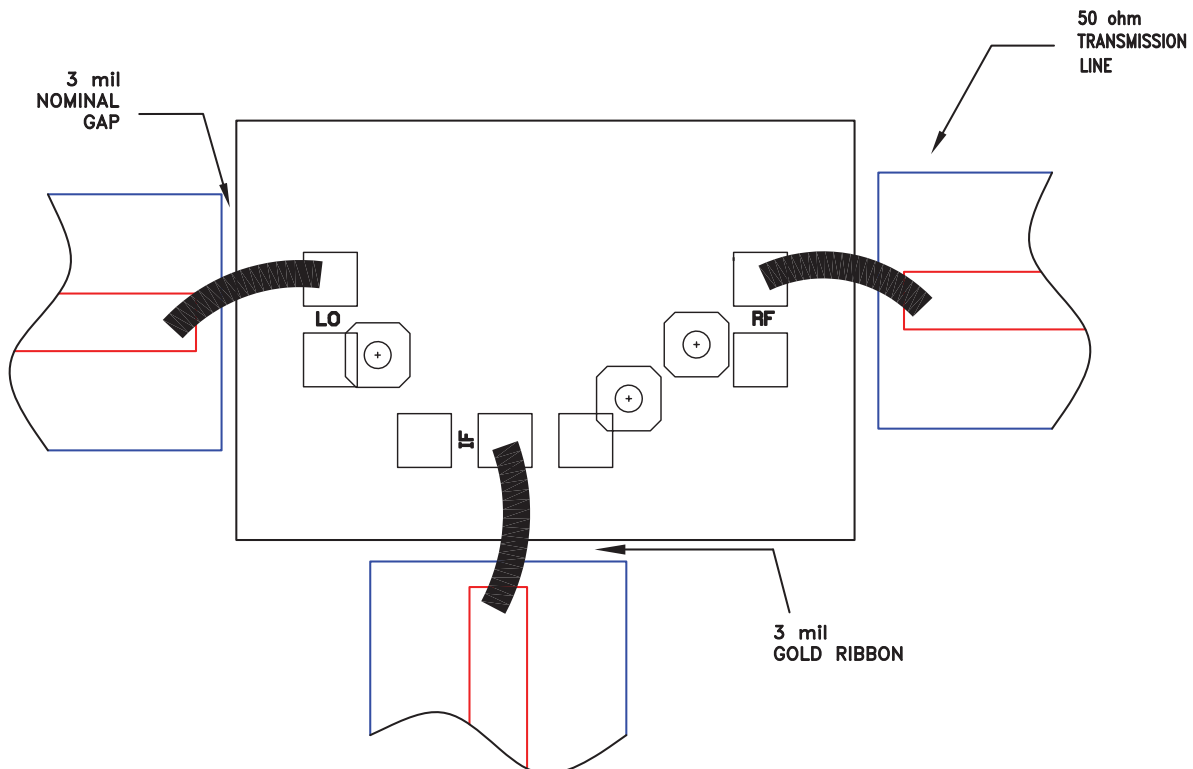

**GaAs MMIC FUNDAMENTAL  
MIXER, 24 - 40 GHz**

**Mounting & Bonding Techniques for Millimeterwave GaAs MMICs**

The die should be attached directly to the ground plane eutectically or with conductive epoxy (see HMC general Handling, Mounting, Bonding Note).

50 Ohm Microstrip transmission lines on 0.127mm (5 mil) thick alumina thin film substrates are recommended for bringing RF to and from the chip (Figure 1). If 0.254mm (10 mil) thick alumina thin film substrates must be used, the die should be raised 0.150mm (6 mils) so that the surface of the die is coplanar with the surface of the substrate. One way to accomplish this is to attach the 0.102mm (4 mil) thick die to a 0.150mm (6 mil) thick molybdenum heat spreader (moly-tab) which is then attached to the ground plane (Figure 2).

Microstrip substrates should be brought as close to the die as possible in order to minimize ribbon bond length. Typical die-to-substrate spacing is 0.076mm (3 mils). Gold ribbon of 0.075 mm (3 mil) width and minimal length <0.31 mm (<12 mils) is recommended to minimize inductance on RF, LO & IF ports.

**Handling Precautions**

Follow these precautions to avoid permanent damage.

**Storage:** All bare die are placed in either Waffle or Gel based ESD protective containers, and then sealed in an ESD protective bag for shipment. Once the sealed ESD protective bag has been opened, all die should be stored in a dry nitrogen environment.

**Cleanliness:** Handle the chips in a clean environment. DO NOT attempt to clean the chip using liquid cleaning systems.

**Static Sensitivity:** Follow ESD precautions to protect against > ± 250V ESD strikes.

**Transients:** Suppress instrument and bias supply transients while bias is applied. Use shielded signal and bias cables to minimize inductive pick-up.

**General Handling:** Handle the chip along the edges with a vacuum collet or with a sharp pair of bent tweezers. The surface of the chip has fragile air bridges and should not be touched with vacuum collet, tweezers, or fingers.

**Mounting**

The chip is back-metallized and can be die mounted with AuSn eutectic preforms or with electrically conductive epoxy. The mounting surface should be clean and flat.

**Eutectic Die Attach:** A 80/20 gold tin preform is recommended with a work surface temperature of 255 °C and a tool temperature of 265 °C. When hot 90/10 nitrogen/hydrogen gas is applied, tool tip temperature should be 290 °C. DO NOT expose the chip to a temperature greater than 320 °C for more than 20 seconds. No more than 3 seconds of scrubbing should be required for attachment.

**Epoxy Die Attach:** Apply a minimum amount of epoxy to the mounting surface so that a thin epoxy fillet is observed around the perimeter of the chip once it is placed into position. Cure epoxy per the manufacturer's schedule.

**Wire Bonding**

RF bonds made with 0.003" x 0.0005" ribbon are recommended. These bonds should be thermosonically bonded with a force of 40-60 grams. DC bonds of 0.001" (0.025 mm) diameter, thermosonically bonded, are recommended. Ball bonds should be made with a force of 40-50 grams and wedge bonds at 18-22 grams. All bonds should be made with a nominal stage temperature of 150 °C. A minimum amount of ultrasonic energy should be applied to achieve reliable bonds. All bonds should be as short as possible, less than 12 mils (0.31 mm).

