

LED55B

LED55C

LED56

PACKAGE DIMENSIONS

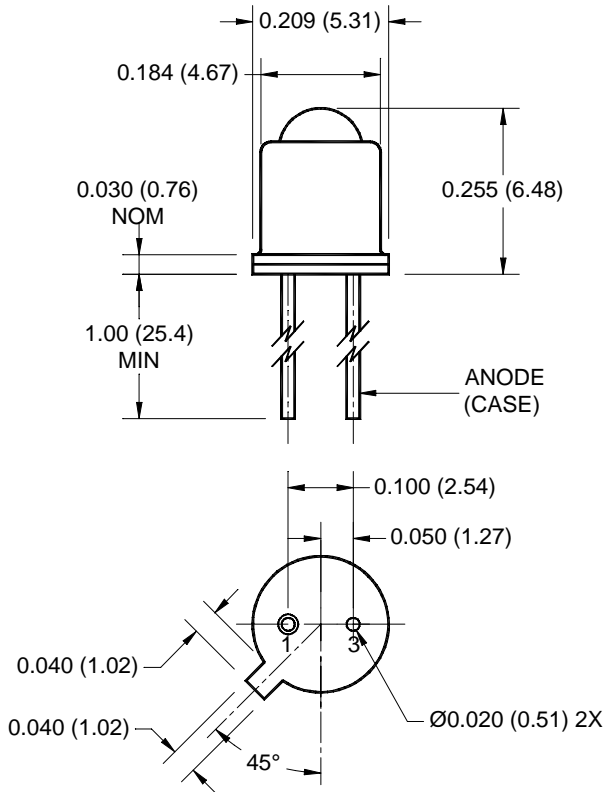

NOTES:

1. Dimensions for all drawings are in inches (mm).
2. Tolerance of $\pm .010$ (.25) on all non-nominal dimensions unless otherwise specified.

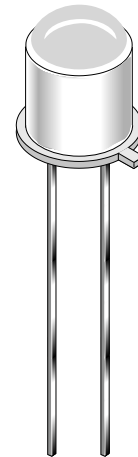

SCHEMATIC

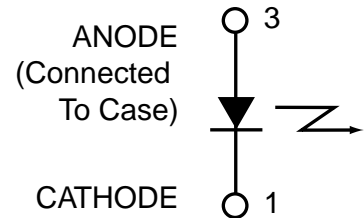

DESCRIPTION

The LED55B/LED55C/LED56 are 940 nm LEDs in a narrow angle, TO-46 package.

FEATURES

- Good optical to mechanical alignment
- Mechanically and wavelength matched to the TO-18 series phototransistor
- Hermetically sealed package
- High irradiance level

LED55B
LED55C
LED56
ABSOLUTE MAXIMUM RATINGS ($T_A = 25^\circ\text{C}$ unless otherwise specified)

Parameter	Symbol	Rating	Unit
Operating Temperature	T_{OPR}	-65 to +125	$^\circ\text{C}$
Storage Temperature	T_{STG}	-65 to +150	$^\circ\text{C}$
Soldering Temperature (Iron) ^(3,4,5 and 6)	T_{SOL-I}	240 for 5 sec	$^\circ\text{C}$
Soldering Temperature (Flow) ^(3,4 and 6)	T_{SOL-F}	260 for 10 sec	$^\circ\text{C}$
Continuous Forward Current	I_F	100	mA
Forward Current (pw, 1 μs ; 200Hz)	I_F	10	A
Reverse Voltage	V_R	3	V
Power Dissipation ($T_A = 25^\circ\text{C}$) ⁽¹⁾	P_D	170	mW
Power Dissipation ($T_C = 25^\circ\text{C}$) ⁽²⁾	P_D	1.3	W

NOTE:

1. Derate power dissipation linearly 1.70 mW/ $^\circ\text{C}$ above 25 $^\circ\text{C}$ ambient.
2. Derate power dissipation linearly 13.0 mW/ $^\circ\text{C}$ above 25 $^\circ\text{C}$ case.
3. RMA flux is recommended.
4. Methanol or isopropyl alcohols are recommended as cleaning agents.
5. Soldering iron tip 1/16" (1.6mm) minimum from housing.
6. As long as leads are not under any stress or spring tension
7. Total power output, P_O , is the total power radiated by the device into a solid angle of 2π steradians.

ELECTRICAL / OPTICAL CHARACTERISTICS ($T_A = 25^\circ\text{C}$) (All measurements made under pulse conditions)

PARAMETER	TEST CONDITIONS	SYMBOL	MIN	TYP	MAX	UNITS
Peak Emission Wavelength	$I_F = 100\text{ mA}$	λ_P	—	940	—	nm
Emission Angle at 1/2 Power	$I_F = 100\text{ mA}$	θ	—	± 8	—	Deg.
Forward Voltage	$I_F = 100\text{ mA}$	V_F	—	—	1.7	V
Reverse Leakage Current	$V_R = 3\text{ V}$	I_R	—	—	10	μA
Total Power LED55B ⁽⁷⁾	$I_F = 100\text{ mA}$	P_O	3.5	—	—	mW
Total Power LED55C ⁽⁷⁾	$I_F = 100\text{ mA}$	P_O	5.4	—	—	mW
Total Power LED56 ⁽⁷⁾	$I_F = 100\text{ mA}$	P_O	1.5	—	—	mW
Rise Time 0-90% of output		t_r	—	1.0	—	μs
Fall Time 100-10% of output		t_f	—	1.0	—	μs

TYPICAL PERFORMANCE CURVES

Figure 1. Power Output vs. Input Current

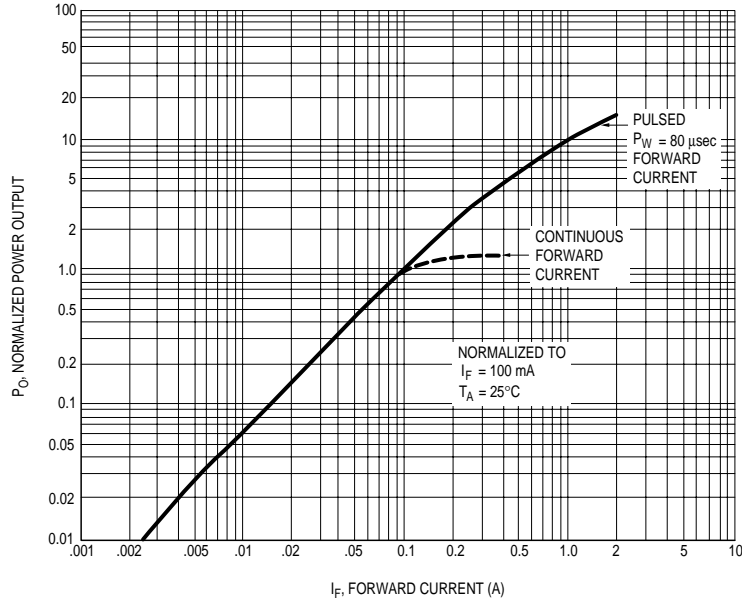

Figure 2. Power Output vs. Temperature

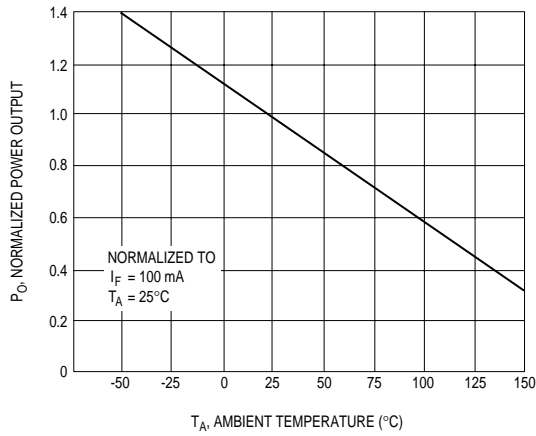

Figure 3. Forward Voltage vs. Forward Current

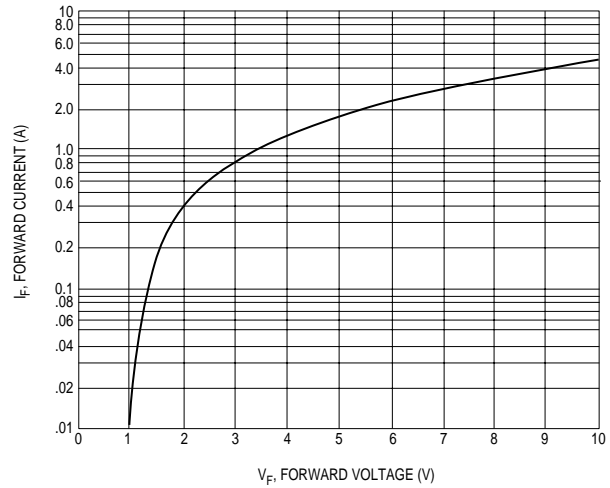

Figure 4. Forward Voltage vs. Forward Current

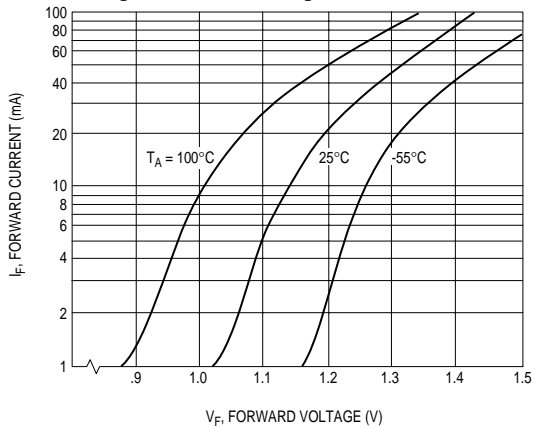
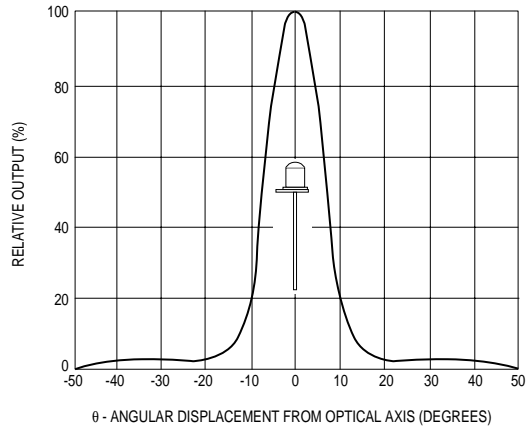

Figure 5. Typical Radiation Pattern



DISCLAIMER

FAIRCHILD SEMICONDUCTOR RESERVES THE RIGHT TO MAKE CHANGES WITHOUT FURTHER NOTICE TO ANY PRODUCTS HEREIN TO IMPROVE RELIABILITY, FUNCTION OR DESIGN. FAIRCHILD DOES NOT ASSUME ANY LIABILITY ARISING OUT OF THE APPLICATION OR USE OF ANY PRODUCT OR CIRCUIT DESCRIBED HEREIN; NEITHER DOES IT CONVEY ANY LICENSE UNDER ITS PATENT RIGHTS, NOR THE RIGHTS OF OTHERS.

LIFE SUPPORT POLICY

FAIRCHILD'S PRODUCTS ARE NOT AUTHORIZED FOR USE AS CRITICAL COMPONENTS IN LIFE SUPPORT DEVICES OR SYSTEMS WITHOUT THE EXPRESS WRITTEN APPROVAL OF THE PRESIDENT OF FAIRCHILD SEMICONDUCTOR CORPORATION. As used herein:

1. Life support devices or systems are devices or systems which, (a) are intended for surgical implant into the body, or (b) support or sustain life, and (c) whose failure to perform when properly used in accordance with instructions for use provided in labeling, can be reasonably expected to result in a significant injury of the user.
2. A critical component in any component of a life support device or system whose failure to perform can be reasonably expected to cause the failure of the life support device or system, or to affect its safety or effectiveness.

Fairchild Semiconductor

SEARCH | [Parametric](#) | [Cross Reference](#) | [Inventory](#)
[space](#) [Product Folders and](#) [Applie](#)

[find products](#) [Home >> Find products >>](#)

- [Products groups](#)
- [Analog and Mixed](#)
- [Signal](#)
- [Discrete](#)
- [Interface](#)
- [Logic](#)
- [Microcontrollers](#)
- [Non-Volatile](#)
- [Memory](#)
- [Optoelectronics](#)
- [Markets and applications](#)
- [New products](#)
- [Product selection and parametric search](#)
- [Cross-reference search](#)

- [technical information](#)
- [buy products](#)
- [technical support](#)
- [my Fairchild](#)
- [company](#)

LED55C
GaAs Infrared Emitting Diode

Contents
[General description](#) | [Features](#) | [Testing conditions](#) | [Product status/pricing/packaging](#)

General description

The LED55B/LED55C and LED56 are 940 nm LEDs in a narrow angle, TO-46 package.

[back to top](#)

Features

- Good optical to mechanical alignment
- Mechanically and wavelength matched to the TO-18 series phototransistor
- Hermetically sealed package
- High irradiance level

[back to top](#)

Testing conditions

- $P_0 @ I_F = 100 \text{ mA}$

[back to top](#)

Product status/pricing/packaging

Product	Product status	Pricing*	Inventory check & ordering	Package type	Packing method
LED55CB	Full Production	N/A	Purchase	TO-46	BULK
LED55C	Full Production	\$0.91	Purchase	TO-46	BULK

Datasheet
[Download this datasheet](#)



[e-mail this datasheet](#)



This page
[Print version](#)

Related Links

- [Request samples](#)
- [How to order products](#)
- [Product Change Notices \(PCNs\)](#)
- [Support](#)
- [Distributor and field sales representatives](#)
- [Quality and reliability](#)
- [Design tools](#)

* Fairchild 1,000 piece Budgetary Pricing

[back to top](#)

[Home](#) | [Find products](#) | [Technical information](#) | [Buy products](#) |
[Support](#) | [Company](#) | [Contact us](#) | [Site index](#) | [Privacy policy](#)

[© Copyright 2002 Fairchild Semiconductor](#)
