

ASDL-4671

High Performance T-1 (3mm) AlGaAs/GaAs Infrared (940nm) Lamp



Data Sheet

Description

ASDL-4671 is a high performance Infrared emitter that utilizes AlGaAs on GaAs LED technology. It is optimized for high efficiency at emission wavelength of 940nm and is designed for application that requires high radiant intensity, low forward voltage at narrow viewing angle. The emitter is encapsulated in T1 (3mm) package and is both mechanically and spectrally matched to ASDL-6620 Infrared phototransistor detector.

Features

- T-1 Package
- 940 nm Wavelength
- Narrow Viewing Angle
- Low Forward voltage
- High Efficiency at low currents
- Good Mechanical and Spectral matching to ASDL-6620 Infrared Phototransistor Detector
- Lead Free & ROHS Compliant
- Available in Tape & Reel

Applications

- IR Remote Control for Consumer Device
- IR Remote Control for Industrial Equipment
- Smoke Detector
- Photo-interrupters
- Reflective Applications
- Infrared Illuminator Security Camera

Ordering Information

Part Number	Lead Form	Color	Packaging	Shipping Option
ASDL-4671-C22	Straight	Clear	Tape & Reel	4000pcs
ASDL-4671-C31			Bulk	8000pcs / Carton
ASDL-4671-D22		Smoke	Tape & Reel	4000pcs
ASDL-4671-D31			Bulk	8000pcs / Carton

Package Dimensions

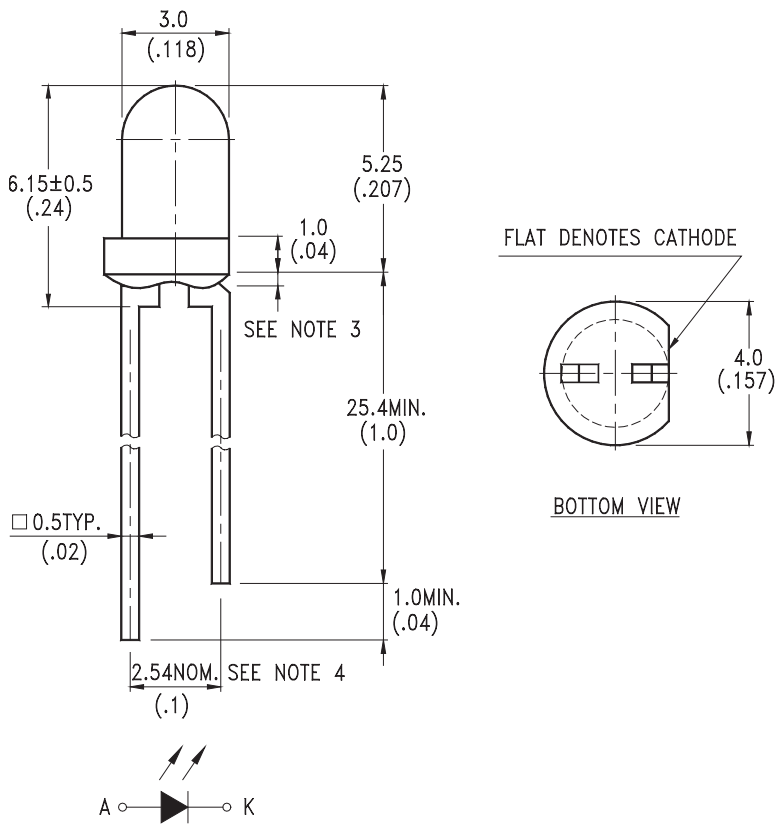

Notes:

1. All dimensions are in millimeters (inches)
2. Tolerance is + 0.25mm (.010") unless otherwise noted
3. Protruded resin under flange is 1.0mm (.039") max
4. Lead spacing is measured where leads emerge from package
5. Specifications are subject to change without notice

Absolute Maximum Ratings at 25°C

Parameter	Symbol	Min.	Max	Unit	Reference
Peak Forward Current	I_{FPK}		1	A	300 pps
Continuous Forward Current	I_{FDC}		60	mA	
Power Dissipation	P_{DISS}		90	mW	
Reverse Voltage	V_R		5	V	
Operating Temperature	T_O	-40	85	°C	
Storage Temperature	T_S	-55	100	°C	
LED Junction Temperature	T_J		110	°C	
Lead Soldering Temperature [1.6mm (0.063") From Body]			260 °C for 5 sec		

Electrical Characteristics at 25°C

Parameter	Symbol	Min.	Typ.	Max.	Unit	Condition
Forward Voltage	V_F		1.2	1.6	V	$I_{FDC} = 20\text{mA}$
Reverse Voltage	V_R	5			V	$I_R = 100\mu\text{A}$
Thermal Resistance, Junction to Ambient	$R\theta_{JA}$		350		°C/W	

Optical Characteristics at 25°C

Parameter	Symbol	Min.	Typ.	Max.	Unit	Condition
Radiant On-Axis Intensity	I_E	3.91			mW/Sr	$I_{FDC} = 20\text{mA}$
Viewing Angle	$2\theta_{1/2}$		20		deg	
Peak wavelength	λ_{PK}		940		nm	$I_{FDC} = 20\text{mA}$
Spectral Width	$\Delta\lambda$		50		nm	$I_{FDC} = 20\text{mA}$
Optical Rise Time	t_r		1		μs	$I_{FPK} = 100\text{mA}$ Duty Factor=50% Pulse Width=10us
Optical Fall Time	t_f		1		μs	$I_{FPK} = 100\text{mA}$ Duty Factor=50% Pulse Width=10us

Typical Electrical/Optical Characteristics Curves ($T_A=25^\circ\text{C}$ unless otherwise indicated)

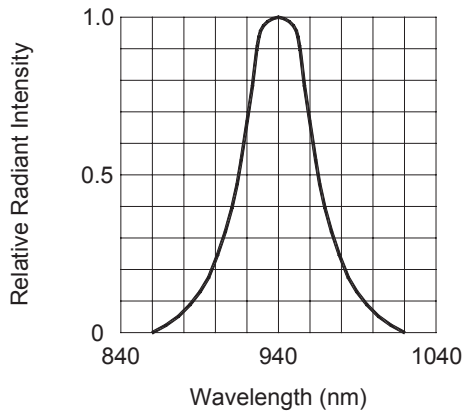

Figure 1. SPECTRAL DISTRIBUTION

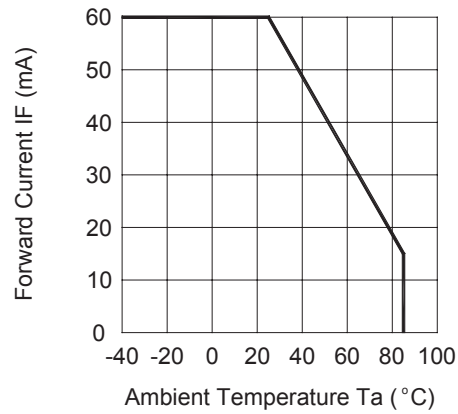

Figure 2. FORWARD CURRENT VS. AMBIENT TEMPERATURE

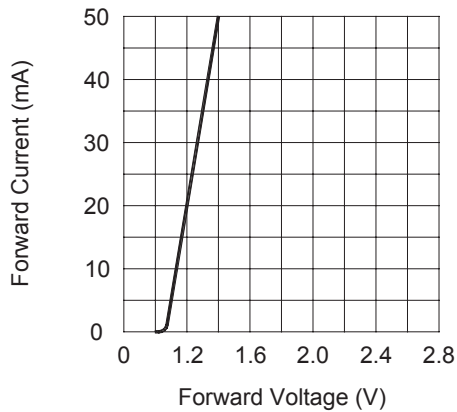

Figure 3. FORWARD CURRENT VS. FORWARD VOLTAGE

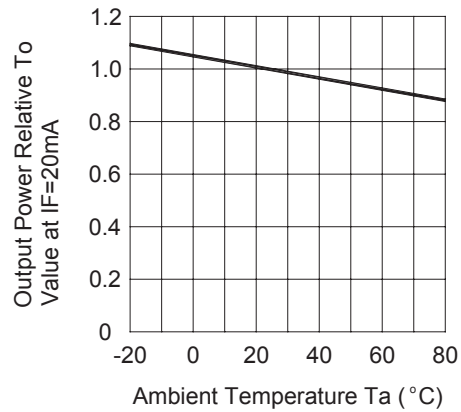

Figure 4. RELATIVE RADIANT INTENSITY VS. AMBIENT TEMPERATURE

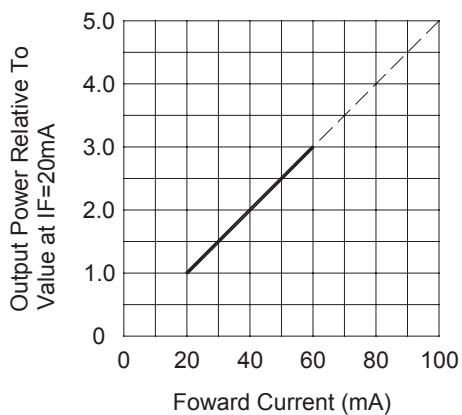

Figure 5. RELATIVE RADIANT INTENSITY VS. FORWARD CURRENT

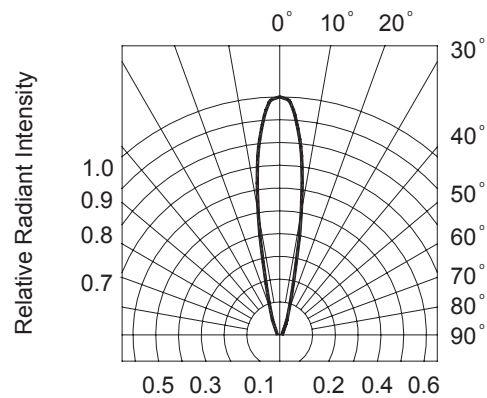

Figure 6. RADIATION DIAGRAM

For company and product information, please go to our web site: [WWW.liteon.com](http://www.liteon.com) or <http://optodatabook.liteon.com/databook/databook.aspx>

Data subject to change. Copyright © 2007 Lite-On Technology Corporation. All rights reserved.

LITEON®