

Cool MOS™ Power Transistor

Feature

- New revolutionary high voltage technology
- Ultra low gate charge
- Periodic avalanche rated
- Extreme dv/dt rated
- Ultra low effective capacitances
- Pb-free lead plating; RoHS compliant
- Qualified according to JEDEC⁰⁾ for target applications

$V_{DS} @ T_{jmax}$	650	V
$R_{DS(on)}$	3	Ω
I_D	1.8	A

PG-TO251

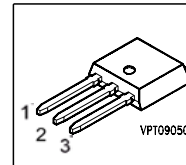

PG-TO252

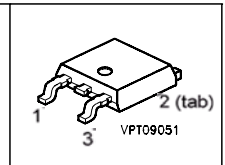

Type	Package	Ordering Code	Marking
SPD02N60C3	PG-TO252	Q67040-S4420	02N60C3
SPU02N60C3	PG-TO251		02N60C3

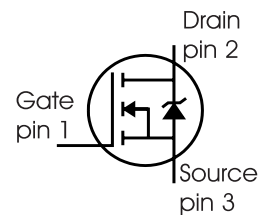

Maximum Ratings

Parameter	Symbol	Value	Unit
Continuous drain current $T_C = 25\text{ }^\circ\text{C}$ $T_C = 100\text{ }^\circ\text{C}$	I_D	1.8 1.1	A
Pulsed drain current, t_p limited by T_{jmax}	$I_{D\text{ puls}}$	5.4	
Avalanche energy, single pulse $I_D = 1.35\text{ A}$, $V_{DD} = 50\text{ V}$	E_{AS}	50	mJ
Avalanche energy, repetitive t_{AR} limited by T_{jmax} ¹ $I_D = 1.8\text{ A}$, $V_{DD} = 50\text{ V}$	E_{AR}	0.07	
Avalanche current, repetitive t_{AR} limited by T_{jmax}	I_{AR}	1.8	A
Gate source voltage static	V_{GS}	± 20	V
Gate source voltage AC ($f > 1\text{ Hz}$)	V_{GS}	± 30	
Power dissipation, $T_C = 25\text{ }^\circ\text{C}$	P_{tot}	25	W
Operating and storage temperature	T_j, T_{stg}	-55... +150	$^\circ\text{C}$
Reverse diode dv/dt ⁵⁾	dv/dt	15	V/ns

Maximum Ratings

Parameter	Symbol	Value	Unit
Drain Source voltage slope $V_{DS} = 480 \text{ V}$, $I_D = 1.8 \text{ A}$, $T_j = 125 \text{ }^\circ\text{C}$	dv/dt	50	V/ns

Thermal Characteristics

Parameter	Symbol	Values			Unit
		min.	typ.	max.	
Thermal resistance, junction - case	R_{thJC}	-	-	5	K/W
Thermal resistance, junction - ambient, leaded	R_{thJA}	-	-	75	
SMD version, device on PCB: @ min. footprint @ 6 cm ² cooling area ²⁾	R_{thJA}	-	-	75 50	
Soldering temperature, *) 1.6 mm (0.063 in.) from case for 10s	T_{sold}	-	-	260	$^\circ\text{C}$

Electrical Characteristics, at $T_j=25^\circ\text{C}$ unless otherwise specified

Parameter	Symbol	Conditions	Values			Unit
			min.	typ.	max.	
Drain-source breakdown voltage	$V_{(BR)DSS}$	$V_{GS}=0\text{V}$, $I_D=0.25\text{mA}$	600	-	-	V
Drain-Source avalanche breakdown voltage	$V_{(BR)DS}$	$V_{GS}=0\text{V}$, $I_D=0.25\text{A}$	-	700	-	
Gate threshold voltage	$V_{GS(th)}$	$I_D=80\mu\text{A}$, $V_{GS}=V_{DS}$	2.1	3	3.9	
Zero gate voltage drain current	I_{DSS}	$V_{DS}=600\text{V}$, $V_{GS}=0\text{V}$, $T_j=25^\circ\text{C}$, $T_j=150^\circ\text{C}$	-	0.5	1 50	μA
Gate-source leakage current	I_{GSS}	$V_{GS}=30\text{V}$, $V_{DS}=0\text{V}$	-	-	100	nA
Drain-source on-state resistance	$R_{DS(on)}$	$V_{GS}=10\text{V}$, $I_D=1.1\text{A}$, $T_j=25^\circ\text{C}$ $T_j=150^\circ\text{C}$	-	2.7 7.3	3 -	Ω
Gate input resistance	R_G	$f=1\text{MHz}$, open Drain	-	9	-	

*) TO252: reflow soldering, MSL3; TO251: wavesoldering

Electrical Characteristics , at $T_j = 25\text{ }^\circ\text{C}$, unless otherwise specified

Parameter	Symbol	Conditions	Values			Unit
			min.	typ.	max.	
Transconductance	g_{fs}	$V_{DS} \geq 2 \cdot I_D \cdot R_{DS(on)max}$, $I_D = 1.1\text{A}$	-	1.75	-	S
Input capacitance	C_{iss}	$V_{GS} = 0\text{V}$, $V_{DS} = 25\text{V}$, $f = 1\text{MHz}$	-	200	-	pF
Output capacitance	C_{oss}		-	90	-	
Reverse transfer capacitance	C_{rss}		-	4	-	
Effective output capacitance, ³⁾ energy related	$C_{o(er)}$	$V_{GS} = 0\text{V}$, $V_{DS} = 0\text{V to } 480\text{V}$	-	8.1	-	pF
Effective output capacitance, ⁴⁾ time related	$C_{o(tr)}$		-	15.7	-	
Turn-on delay time	$t_{d(on)}$	$V_{DD} = 350\text{V}$, $V_{GS} = 0/10\text{V}$, $I_D = 1.8\text{A}$, $R_G = 25\Omega$	-	6	-	ns
Rise time	t_r		-	3	-	
Turn-off delay time	$t_{d(off)}$		-	68	70	
Fall time	t_f		-	12	30	

Gate Charge Characteristics

Gate to source charge	Q_{gs}	$V_{DD} = 420\text{V}$, $I_D = 1.8\text{A}$	-	1.6	-	nC
Gate to drain charge	Q_{gd}		-	3.8	-	
Gate charge total	Q_g	$V_{DD} = 420\text{V}$, $I_D = 1.8\text{A}$, $V_{GS} = 0\text{ to } 10\text{V}$	-	9.5	12.5	
Gate plateau voltage	$V_{(plateau)}$	$V_{DD} = 420\text{V}$, $I_D = 1.8\text{A}$	-	5.5	-	V

⁰J-STD20 and JESD22

¹Repetitive avalanche causes additional power losses that can be calculated as $P_{AV} = E_{AR} \cdot f$.

²Device on 40mm*40mm*1.5mm epoxy PCB FR4 with 6cm² (one layer, 70 μm thick) copper area for drain connection. PCB is vertical without blown air.

³ $C_{o(er)}$ is a fixed capacitance that gives the same stored energy as C_{oss} while V_{DS} is rising from 0 to 80% V_{DSS} .

⁴ $C_{o(tr)}$ is a fixed capacitance that gives the same charging time as C_{oss} while V_{DS} is rising from 0 to 80% V_{DSS} .

⁵ $I_{SD} \leq I_D$, $di/dt \leq 400\text{A/us}$, $V_{DClink} = 400\text{V}$, $V_{peak} < V_{BR, DSS}$, $T_j < T_{j,max}$.

Identical low-side and high-side switch.

Electrical Characteristics, at $T_j = 25\text{ }^\circ\text{C}$, unless otherwise specified

Parameter	Symbol	Conditions	Values			Unit
			min.	typ.	max.	
Inverse diode continuous forward current	I_S	$T_C=25^\circ\text{C}$	-	-	1.8	A
Inverse diode direct current, pulsed	I_{SM}		-	-	5.4	
Inverse diode forward voltage	V_{SD}	$V_{GS}=0\text{V}, I_F=I_S$	-	1	1.2	V
Reverse recovery time	t_{rr}	$V_R=420\text{V}, I_F=I_S,$	-	200	350	ns
Reverse recovery charge	Q_{rr}	$di_F/dt=100\text{A}/\mu\text{s}$	-	1.3	-	μC
Peak reverse recovery current	I_{rrm}		-	9	-	A
Peak rate of fall of reverse recovery current	di_{rr}/dt		-	-	200	$\text{A}/\mu\text{s}$

Typical Transient Thermal Characteristics

Symbol	Value	Unit	Symbol	Value	Unit
	typ.			typ.	
Thermal resistance			Thermal capacitance		
R_{th1}	0.1	K/W	C_{th1}	0.00002806	Ws/K
R_{th2}	0.184		C_{th2}	0.0001113	
R_{th3}	0.306		C_{th3}	0.0001679	
R_{th4}	1.207		C_{th4}	0.000547	
R_{th5}	0.974		C_{th5}	0.001388	
R_{th6}	0.251		C_{th6}	0.019	

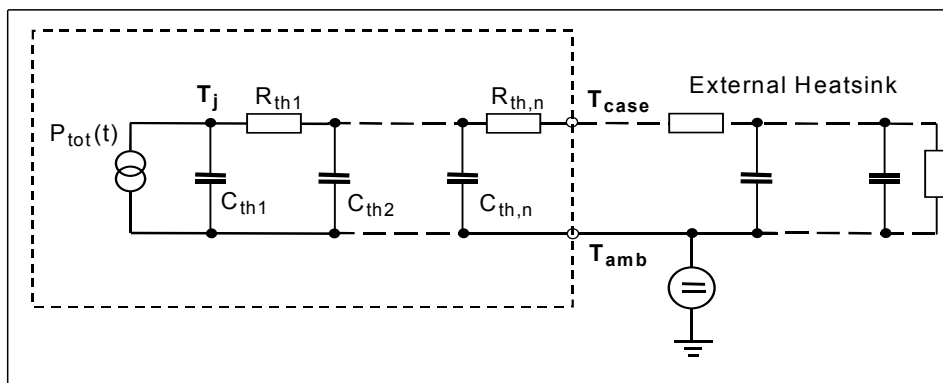

1 Power dissipation

$$P_{tot} = f(T_C)$$

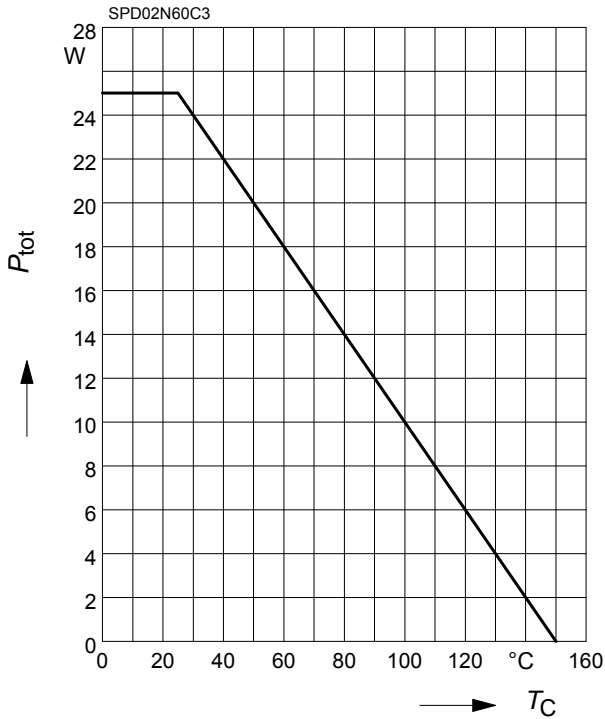

2 Safe operating area

$$I_D = f(V_{DS})$$

parameter : $D = 0$, $T_C = 25^{\circ}C$

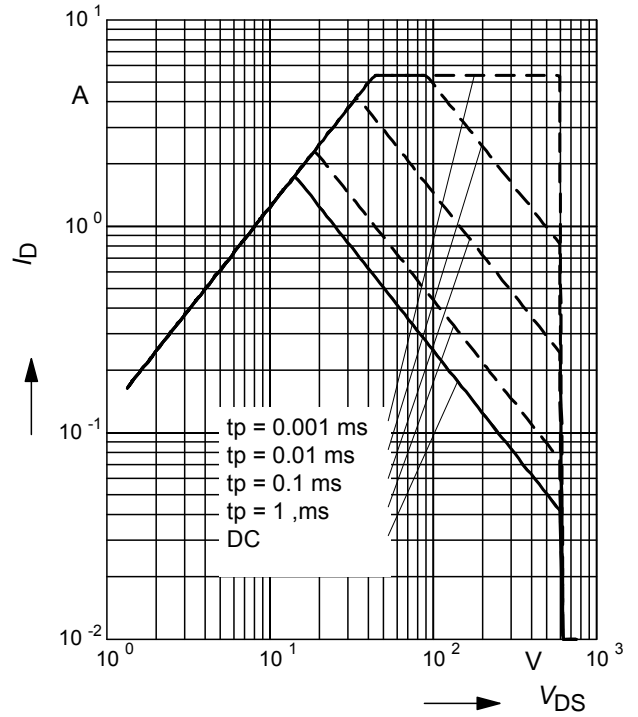

3 Transient thermal impedance

$$Z_{thJC} = f(t_p)$$

parameter: $D = t_p/T$

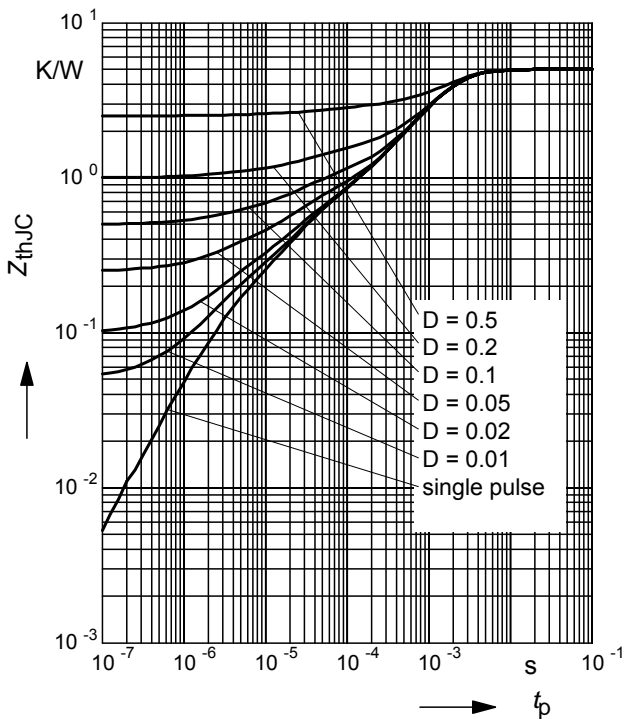

4 Typ. output characteristic

$$I_D = f(V_{DS}); T_j = 25^{\circ}C$$

parameter: $t_p = 10 \mu s$, V_{GS}

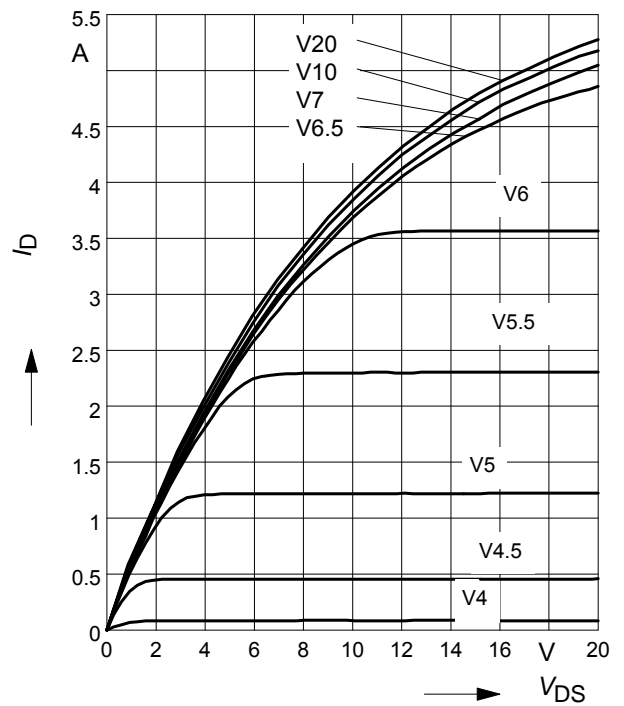

5 Typ. output characteristic

$$I_D = f(V_{DS}); T_j = 150^\circ\text{C}$$

parameter: $t_p = 10 \mu\text{s}$, V_{GS}

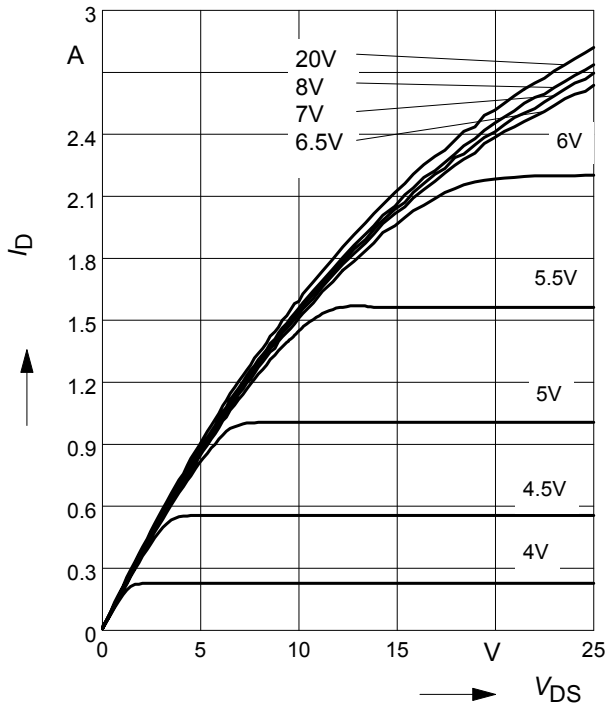

6 Typ. drain-source on resistance

$$R_{DS(on)} = f(I_D)$$

parameter: $T_j = 150^\circ\text{C}$, V_{GS}

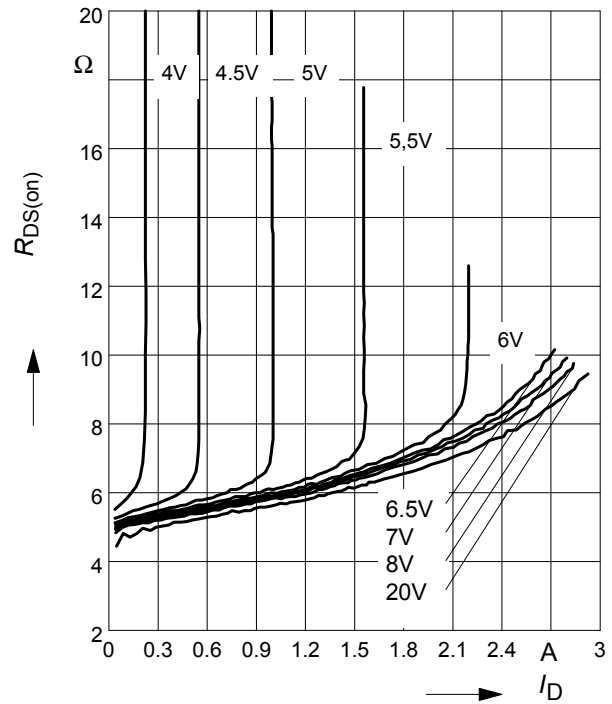

7 Drain-source on-state resistance

$$R_{DS(on)} = f(T_j)$$

parameter: $I_D = 1.1 \text{ A}$, $V_{GS} = 10 \text{ V}$

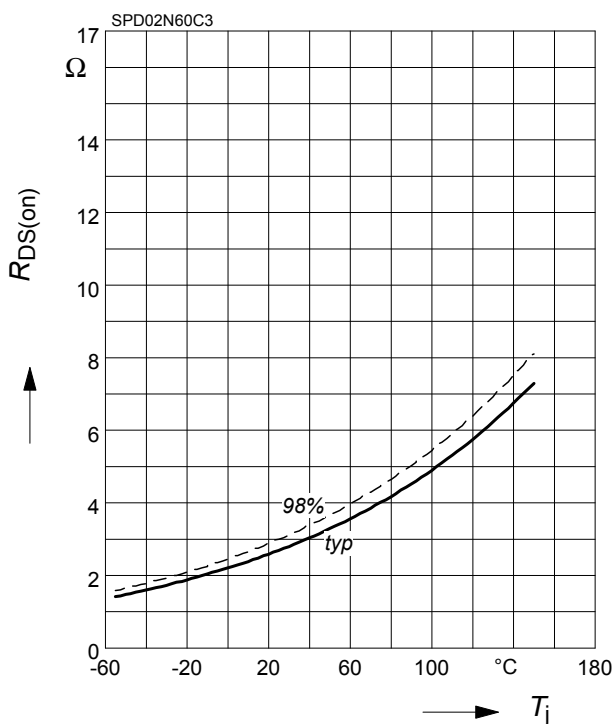

8 Typ. transfer characteristics

$$I_D = f(V_{GS}); V_{DS} \geq 2 \times I_D \times R_{DS(on)max}$$

parameter: $t_p = 10 \mu\text{s}$

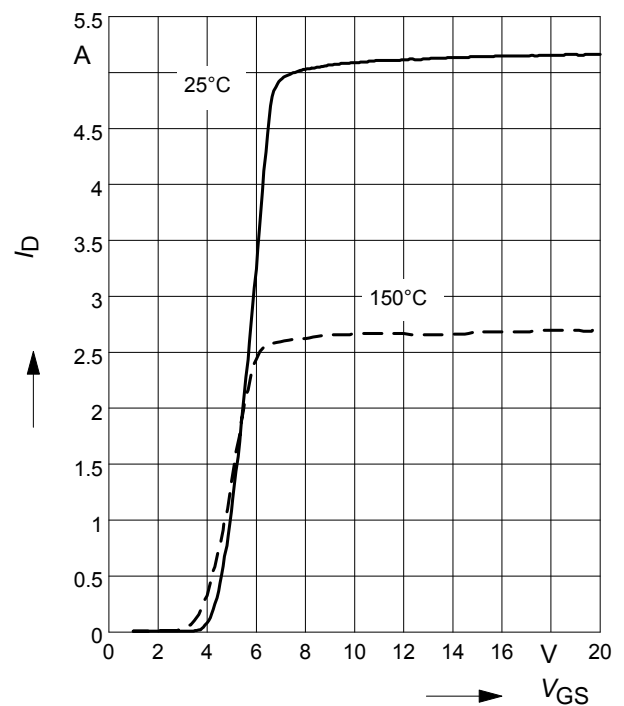

9 Typ. gate charge

$$V_{GS} = f(Q_{Gate})$$

parameter: $I_D = 1.8 \text{ A}$ pulsed

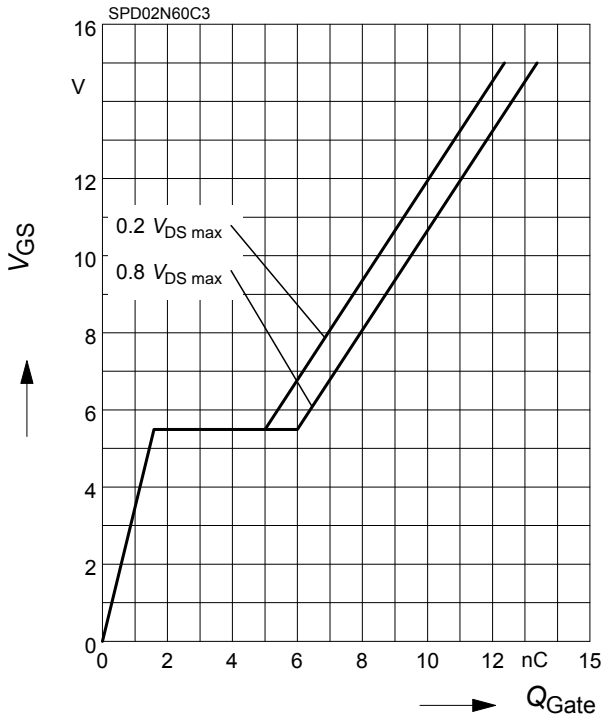

10 Forward characteristics of body diode

$$I_F = f(V_{SD})$$

parameter: $T_j, t_p = 10 \mu\text{s}$

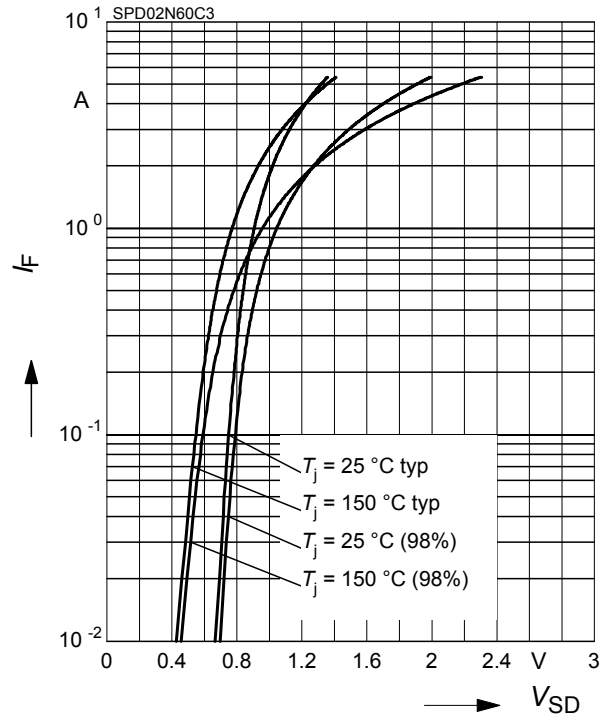

11 Typ. drain current slope

$$di/dt = f(R_G), \text{ inductive load, } T_j = 125^\circ\text{C}$$

par.: $V_{DS}=380\text{V}, V_{GS}=0/+13\text{V}, I_D=1.8\text{A}$

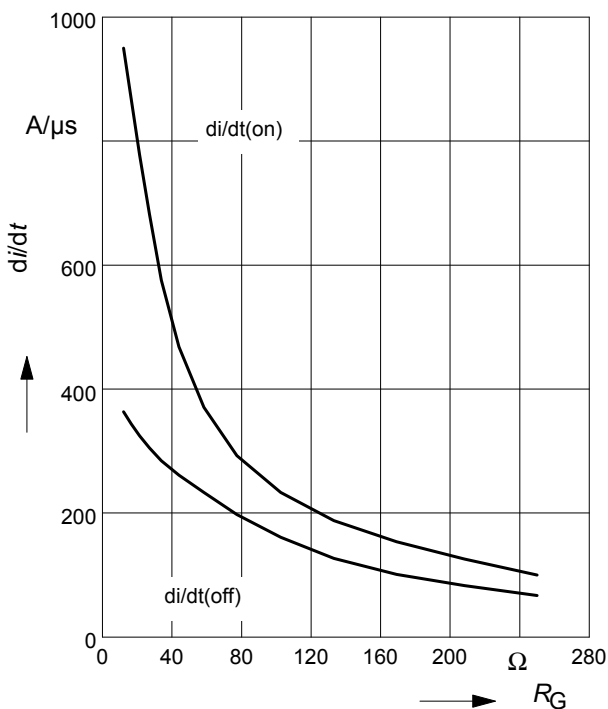

12 Typ. switching time

$$t = f(R_G), \text{ inductive load, } T_j=125^\circ\text{C}$$

par.: $V_{DS}=380\text{V}, V_{GS}=0/+13\text{V}, I_D=1.8 \text{ A}$

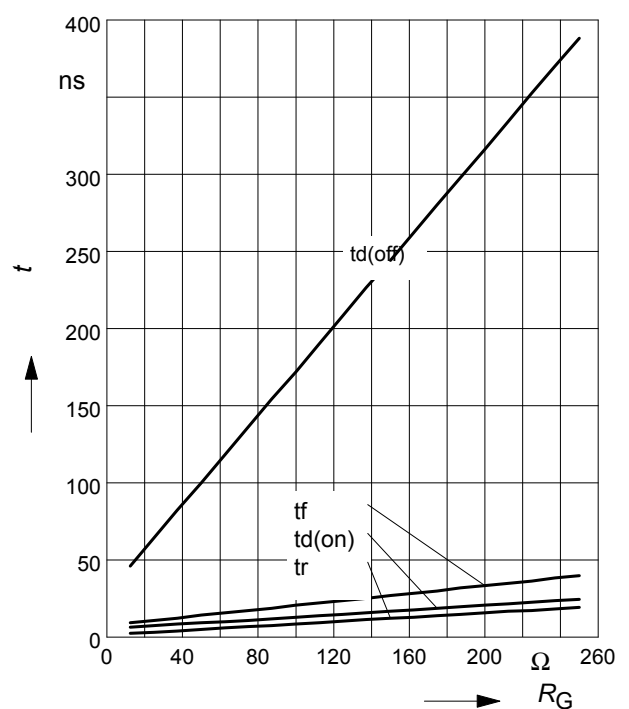

13 Typ. switching time

$t = f(I_D)$, inductive load, $T_j=125^\circ\text{C}$
par.: $V_{DS}=380\text{V}$, $V_{GS}=0/+13\text{V}$, $R_G=25\Omega$

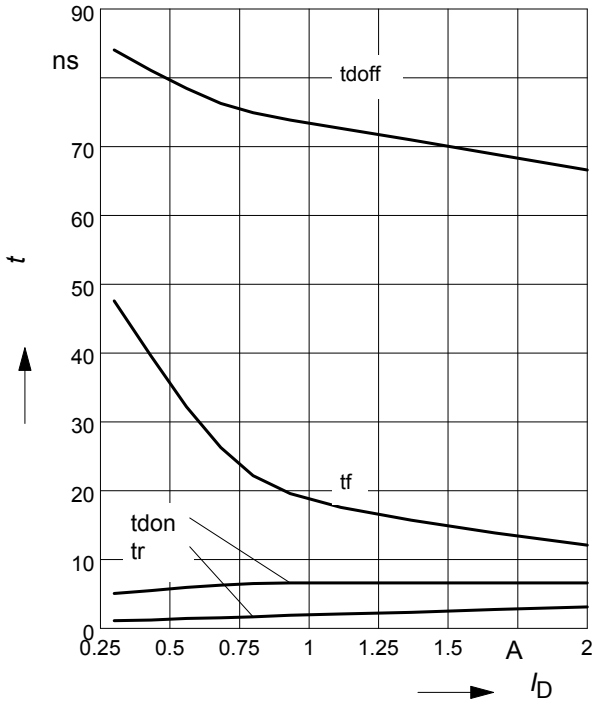

14 Typ. drain source voltage slope

$dv/dt = f(R_G)$, inductive load, $T_j = 125^\circ\text{C}$
par.: $V_{DS}=380\text{V}$, $V_{GS}=0/+13\text{V}$, $I_D=1.8\text{A}$

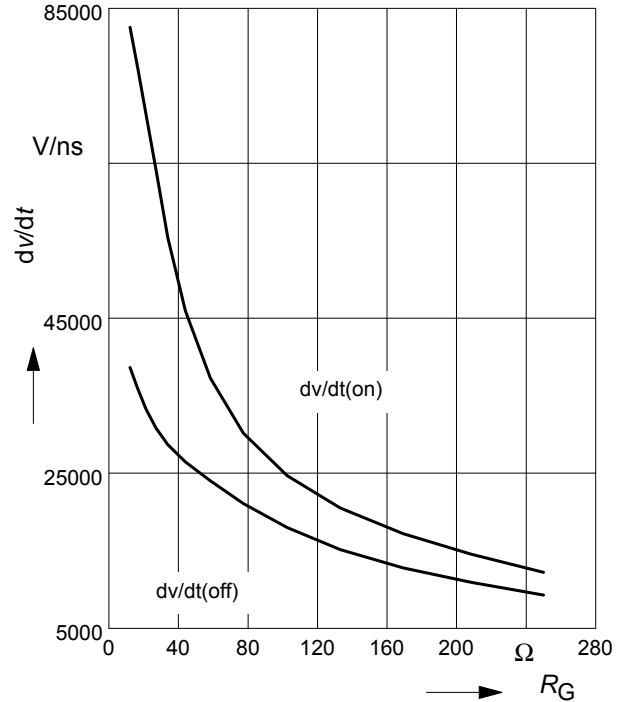

15 Typ. switching losses

$E = f(I_D)$, inductive load, $T_j=125^\circ\text{C}$
par.: $V_{DS}=380\text{V}$, $V_{GS}=0/+13\text{V}$, $R_G=25\Omega$

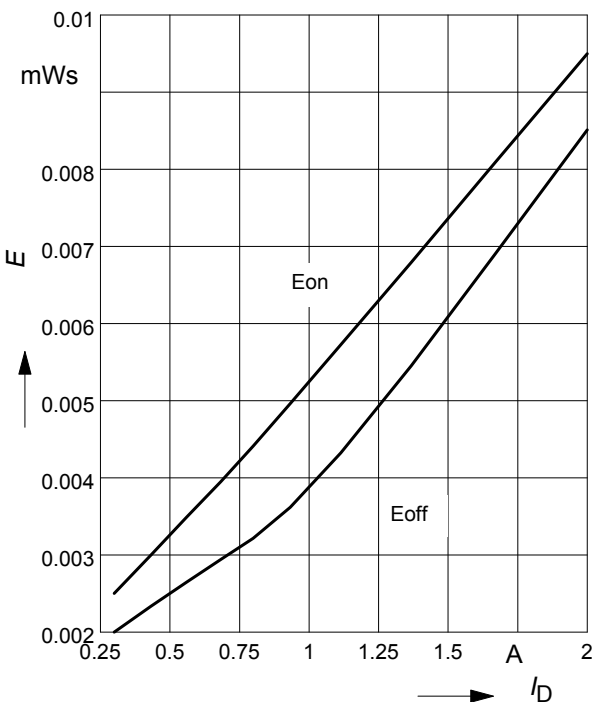

16 Typ. switching losses

$E = f(R_G)$, inductive load, $T_j=125^\circ\text{C}$
par.: $V_{DS}=380\text{V}$, $V_{GS}=0/+13\text{V}$, $I_D=1.8\text{A}$

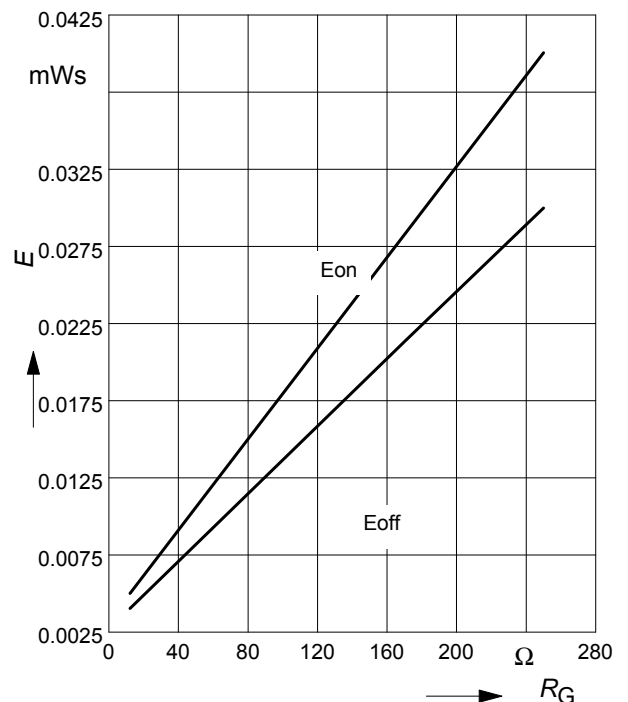

17 Avalanche SOA

$$I_{AR} = f(t_{AR})$$

par.: $T_j \leq 150\text{ }^\circ\text{C}$

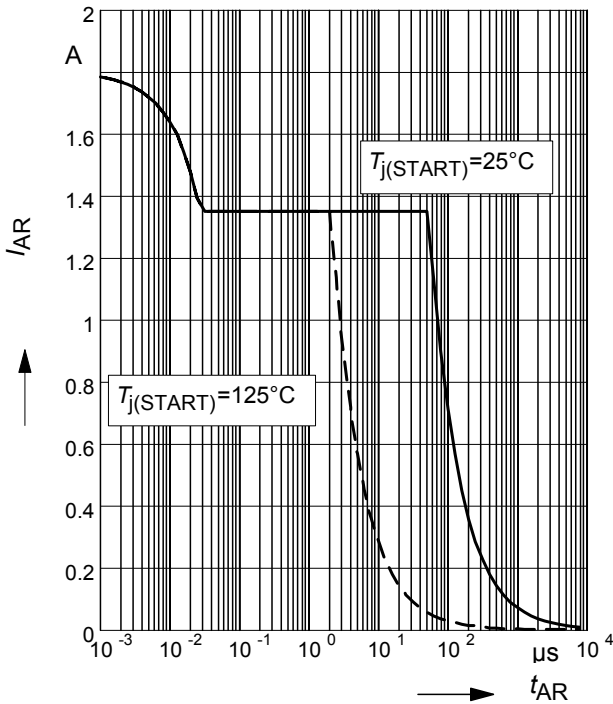

18 Avalanche energy

$$E_{AS} = f(T_j)$$

par.: $I_D = 1.35\text{ A}$, $V_{DD} = 50\text{ V}$

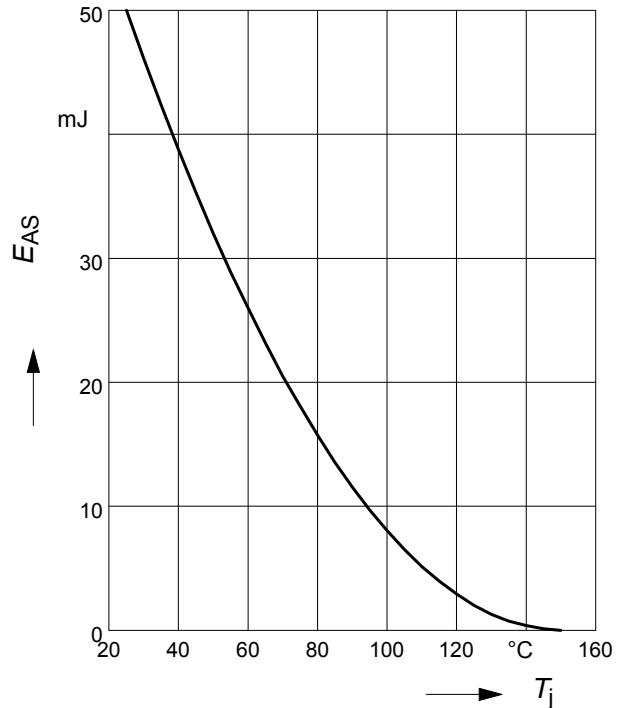

19 Drain-source breakdown voltage

$$V_{(BR)DSS} = f(T_j)$$

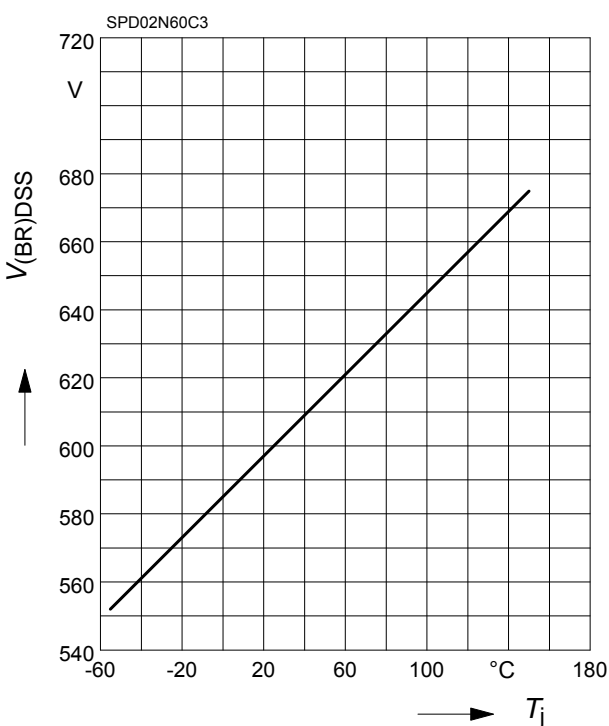

20 Avalanche power losses

$$P_{AR} = f(f)$$

parameter: $E_{AR} = 0.07\text{ mJ}$

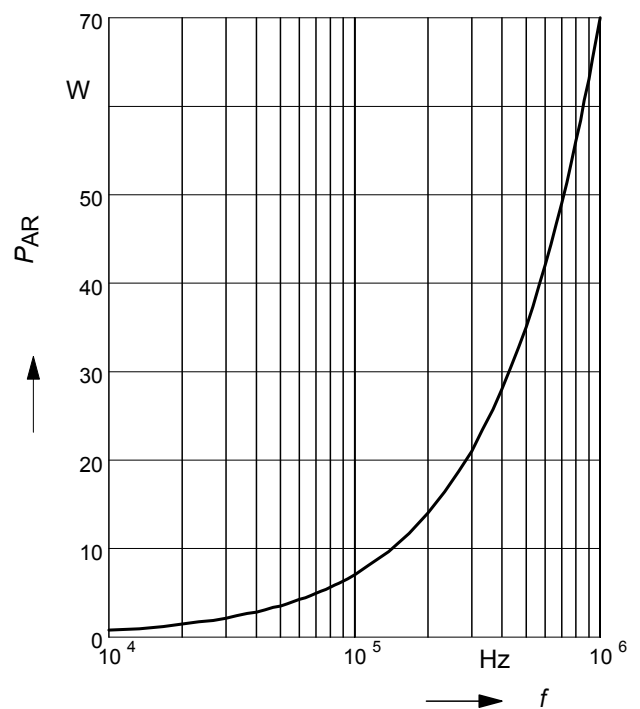

21 Typ. capacitances

$$C = f(V_{DS})$$

parameter: $V_{GS}=0V, f=1\text{ MHz}$

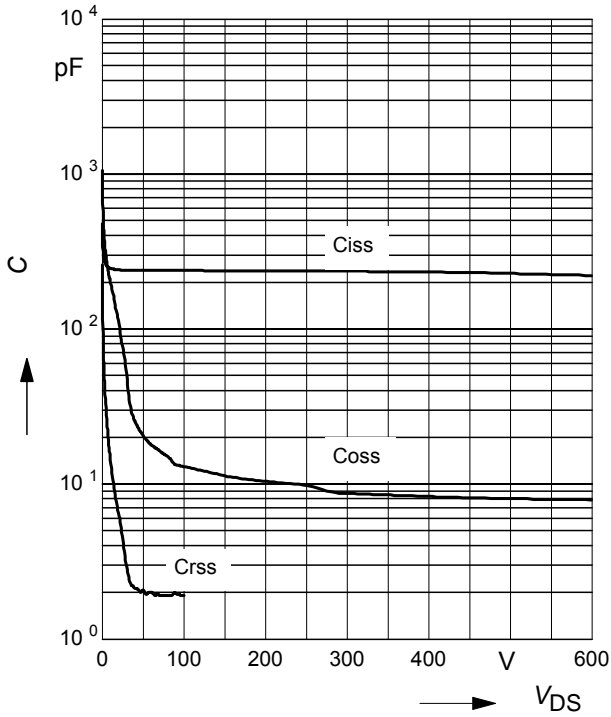

22 Typ. C_{oss} stored energy

$$E_{oss} = f(V_{DS})$$

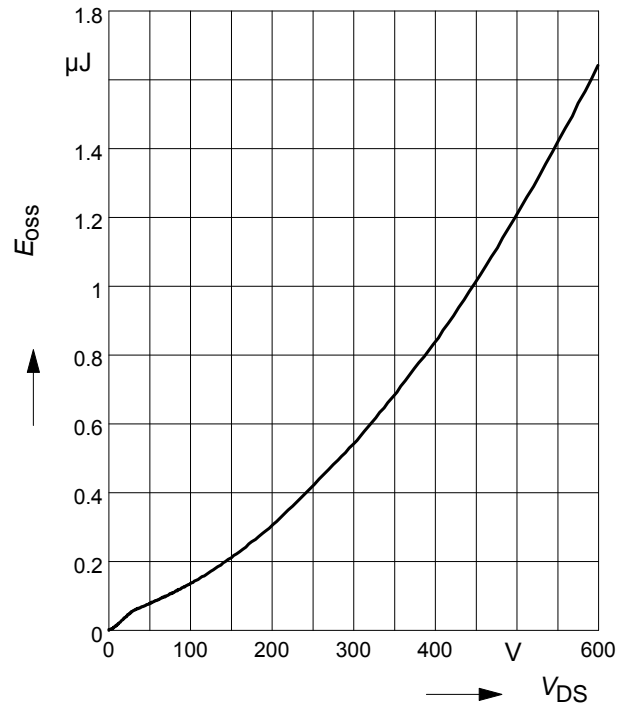

Definition of diodes switching characteristics

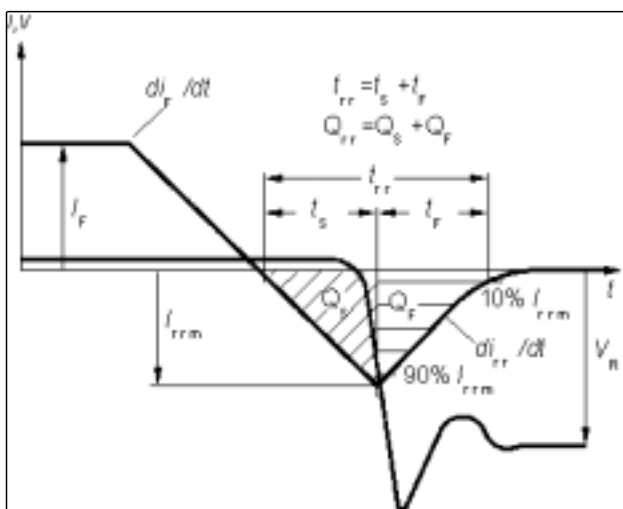

PG-TO-252-3-1 (D-PAK), PG-TO-252-3-11 (D-PAK), PG-TO-252-3-21 (D-PAK)

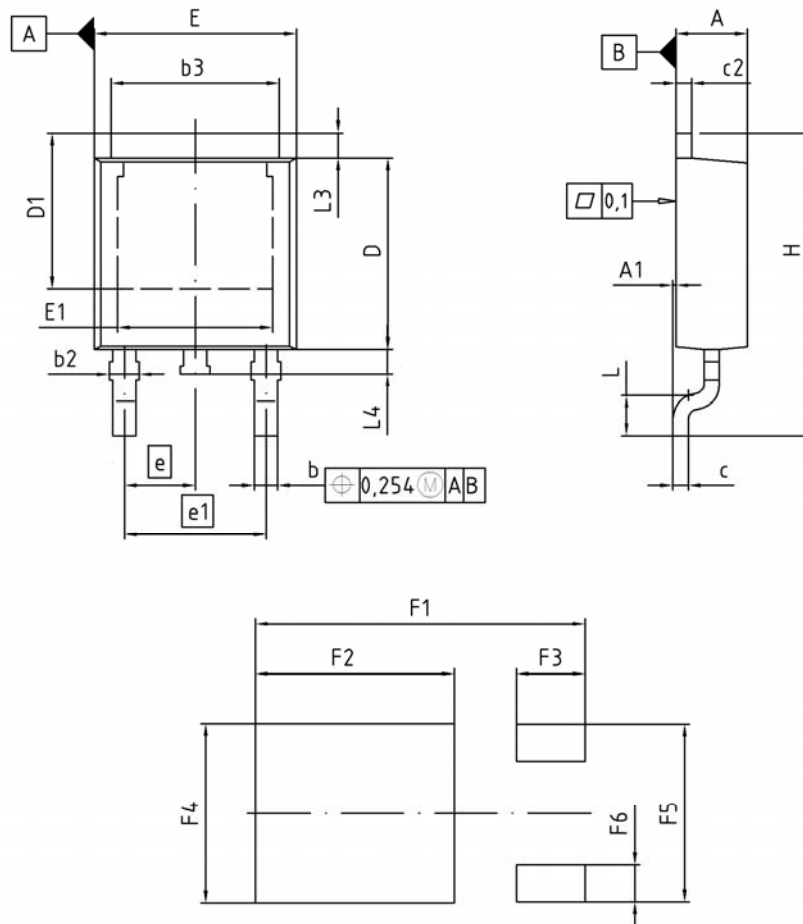

DIM	MILLIMETERS		INCHES	
	MIN	MAX	MIN	MAX
A	2.16	2.41	0.085	0.095
A1	0.00	0.15	0.000	0.006
b	0.64	0.89	0.025	0.035
b2	0.65	1.15	0.026	0.045
b3	5.00	5.50	0.197	0.217
c	0.46	0.60	0.018	0.024
c2	0.46	0.98	0.018	0.039
D	5.97	6.22	0.235	0.245
D1	5.02	5.84	0.198	0.230
E	6.40	6.73	0.252	0.265
E1	4.70	5.21	0.185	0.205
e	2.29		0.090	
e1	4.57		0.180	
N	3		3	
H	9.40	10.48	0.370	0.413
L	1.18	1.70	0.046	0.067
L3	0.90	1.25	0.035	0.049
L4	0.51	1.00	0.020	0.039
F1	10.50	10.70	0.413	0.421
F2	6.30	6.50	0.248	0.256
F3	2.10	2.30	0.083	0.091
F4	5.70	5.90	0.224	0.232
F5	5.66	5.86	0.223	0.231
F6	1.10	1.30	0.043	0.051

DOCUMENT NO.
Z8B00003328

SCALE

0 2.0 4mm

EUROPEAN PROJECTION

ISSUE DATE
19-10-2007

REVISION
03

PG-TO-251-3-1 (I-PAK), PG-TO-251-3-21 (I-PAK)

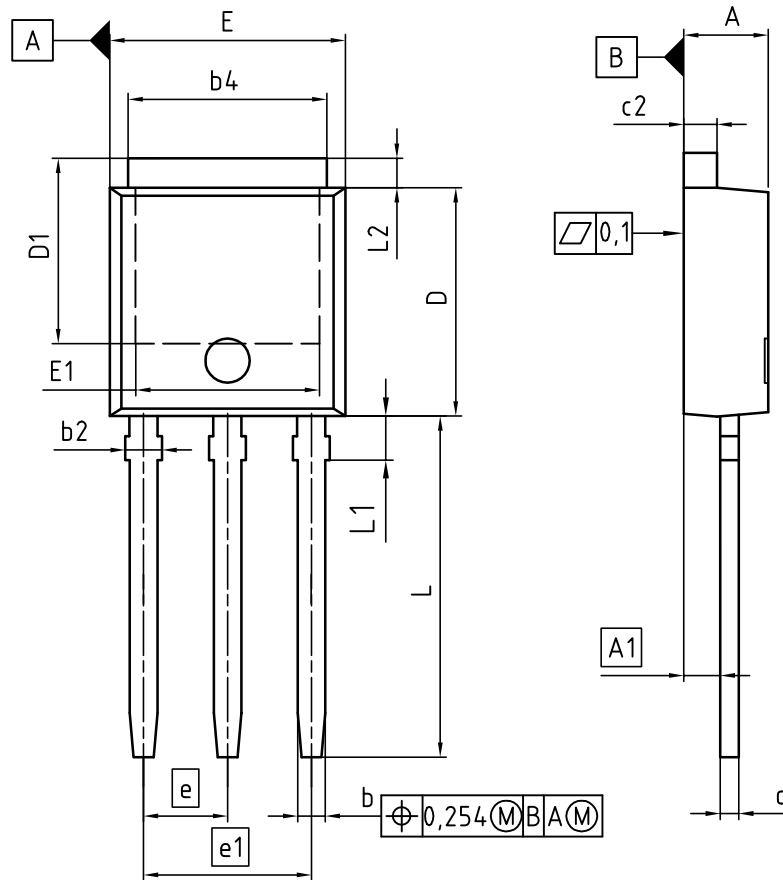

DIM	MILLIMETERS		INCHES	
	MIN	MAX	MIN	MAX
A	2.16	2.41	0.085	0.095
A1	0.90	1.14	0.035	0.045
b	0.64	0.89	0.025	0.035
b2	0.65	1.15	0.026	0.045
b4	4.95	5.50	0.195	0.217
c	0.46	0.60	0.018	0.024
c2	0.46	0.89	0.018	0.035
D	5.97	6.22	0.235	0.245
D1	5.04	5.77	0.198	0.227
E	6.35	6.73	0.250	0.265
E1	4.70	5.21	0.185	0.205
e	2.29		0.090	
e1	4.57		0.180	
N	3		3	
L	8.89	9.65	0.350	0.380
L1	1.90	2.29	0.075	0.090
L2	0.89	1.37	0.035	0.054

DOCUMENT NO.
Z8B00003330

SCALE

EUROPEAN PROJECTION

ISSUE DATE
19-03-2008

REVISION
03

Published by
Infineon Technologies AG
81726 Munich, Germany
© 2008 Infineon Technologies AG
All Rights Reserved.

Legal Disclaimer

The information given in this document shall in no event be regarded as a guarantee of conditions or characteristics. With respect to any examples or hints given herein, any typical values stated herein and/or any information regarding the application of the device, Infineon Technologies hereby disclaims any and all warranties and liabilities of any kind, including without limitation, warranties of non-infringement of intellectual property rights of any third party.

Information

For further information on technology, delivery terms and conditions and prices, please contact the nearest Infineon Technologies Office (www.infineon.com).

Warnings

Due to technical requirements, components may contain dangerous substances. For information on the types in question, please contact the nearest Infineon Technologies Office. Infineon Technologies components may be used in life-support devices or systems only with the express written approval of Infineon Technologies, if a failure of such components can reasonably be expected to cause the failure of that life-support device or system or to affect the safety or effectiveness of that device or system. Life support devices or systems are intended to be implanted in the human body or to support and/or maintain and sustain and/or protect human life. If they fail, it is reasonable to assume that the health of the user or other persons may be endangered.