



Frontier Electronics Corp.

667 E. COCHRAN STREET, SIMI VALLEY, CA 93065

TEL: (805) 522-9998 FAX: (805) 522-9989

E-mail: frontiersales@frontierusa.com

Web: <http://www.frontierusa.com>

2A FAST EFFICIENT SURFACE MOUNT RECTIFIER

ES2A-LFR THRU ES2J-LFR

FEATURES

- LOW PROFILE PACKAGE
- PLASTIC PACKAGE HAS UNDERWRITERS LABORATORY 94V-0
- IDEAL FOR SURFACE MOUNTED APPLICATION
- GLASS PASSIVATED CHIP JUNCTION
- BUILT-IN STRAIN RELIEF DESIGN
- FAST EFFICIENT RECOVERY TIME FOR HIGH EFFICIENT
- HIGH TEMPERATURE SOLDERING: 250°C/10 SECONDS AT TERMINAL
- ROHS

MECHANICAL DATA

- CASE: JEDEC DO-214AA (SMB), MOLDED PLASTIC BODY, DIMENSIONS IN INCHES AND (MILLIMETERS)
- TERMINAL: SOLDER PLATED, SOLDERABLE PER MIL-STD-750 METHOD 2026
- POLARITY: COLOR BAND DENOTES CATHODE
- WEIGHT: 0.093 GRAMS

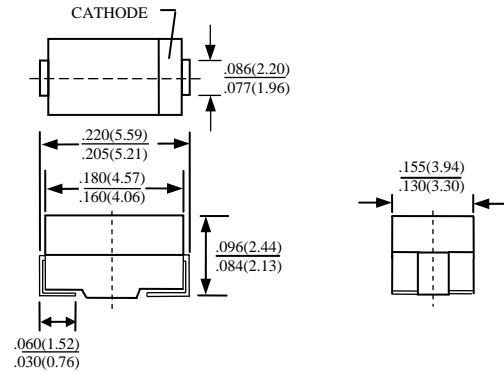

MAXIMUM RATINGS AND ELECTRICAL CHARACTERISTICS RATINGS AT 25°C AMBIENT TEMPERATURE UNLESS OTHERWISE SPECIFIED SINGLE PHASE, HALF WAVE, 60 HZ, RESISTIVE OR INDUCTIVE LOAD. FOR CAPACITIVE LOAD, DERATE CURRENT BY 20%

RATINGS	SYMBOL	ES2A-LFR	ES2B-LFR	ES2D-LFR	ES2E-LFR	ES2G-LFR	ES2J-LFR	UNITS
MAXIMUM RECURRENT PEAK REVERSE VOLTAGE	V_{RRM}	50	100	200	300	400	600	V
MAXIMUM RMS VOLTAGE	V_{RMS}	35	70	140	210	280	420	V
MAXIMUM DC BLOCKING VOLTAGE	V_{DC}	50	100	200	300	400	600	V
MAXIMUM AVERAGE FORWARD RECTIFIED CURRENT AT $T_J=90^\circ\text{C}$	I_O	2.0						A
PEAK FORWARD SURGE CURRENT, 8.3ms SINGLE HALF SINE-WAVE SUPERIMPOSED ON RATED LOAD	I_{FSM}	50						A
TYPICAL JUNCTION CAPACITANCE (NOTE 1)	C_J	25						PF
TYPICAL THERMAL RESISTANCE (NOTE 2)	$R_{\theta JL}$	20						°C/W
STORAGE TEMPERATURE RANGE	T_{STG}	- 55 TO + 150						°C
OPERATING TEMPERATURE RANGE	T_{OP}	- 55 TO + 150						°C

ELECTRICAL CHARACTERISTICS ($A_T T_A = 25^\circ\text{C}$ UNLESS OTHERWISE NOTED)

CHARACTERISTICS	SYMBOL	ES2A-LFR	ES2B-LFR	ES2D-LFR	ES2E-LFR	ES2G-LFR	ES2J-LFR	UNITS
MAXIMUM FORWARD VOLTAGE AT I_O DC	V_F	0.98			1.25		1.75	V
MAXIMUM REVERSE CURRENT AT 25°C	I_R	10						μA
MAXIMUM REVERSE CURRENT AT 100°C	I_R	150						μA
MAXIMUM REVERSE RECOVERY TIME (NOTE 3)	T_{RR}	25						nS
MARKING		ES2A	ES2B	ES2D	ES2E	ES2G	ES2J	

- NOTE:
1. MEASURED AT 1 MHZ AND APPLIED REVERSE VOLTAGE OF 4.0 VOLTS
 2. THERMAL RESISTANCE FROM JUNCTION TO AMBIENT AND JUNCTION TO LEAD P.C.B. MOUNTED ON 0.3×0.3" (8.0×8.0mm) COPPER PAD AREAS
 3. REVERSE RECOVERY TEST CONDITIONS: $I_F=0.5\text{A}$, $I_R=1.0\text{A}$, $I_{RR}=0.25\text{A}$

RATINGS AND CHARACTERISTIC CURVE ES2A-LFR THRU ES2J-LFR

FIG. 1-TEST CIRCUIT DIAGRAM AND REVERSE RECOVERY TIME CHARACTERISTIC

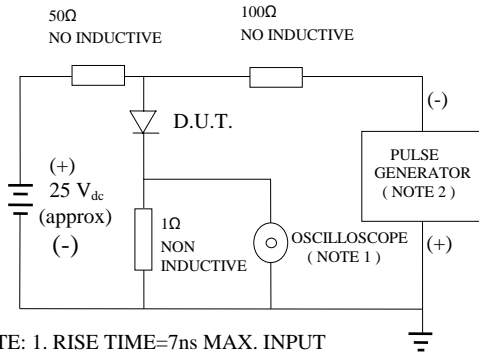

NOTE: 1. RISE TIME=7ns MAX. INPUT IMPEDANCE=1 MOhms 22PF
 2. RISE TIME =10ns MAX. SOURCE IMPEDANCE=50 OHMS

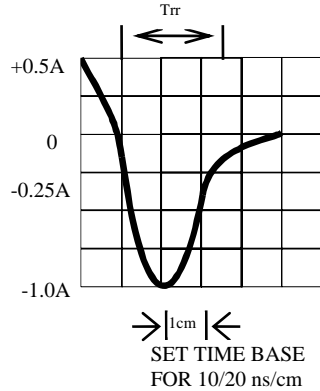

FIG. 2-TYPICAL FORWARD CURRENT DERATING CURVE

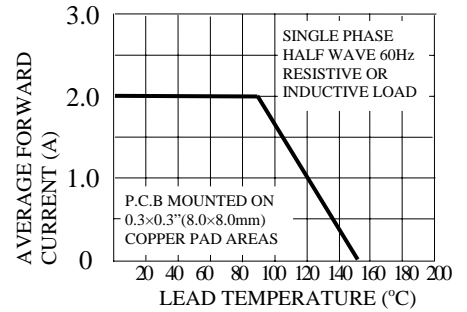

FIG. 3-TYPICAL REVERSE CHARACTERISTICS

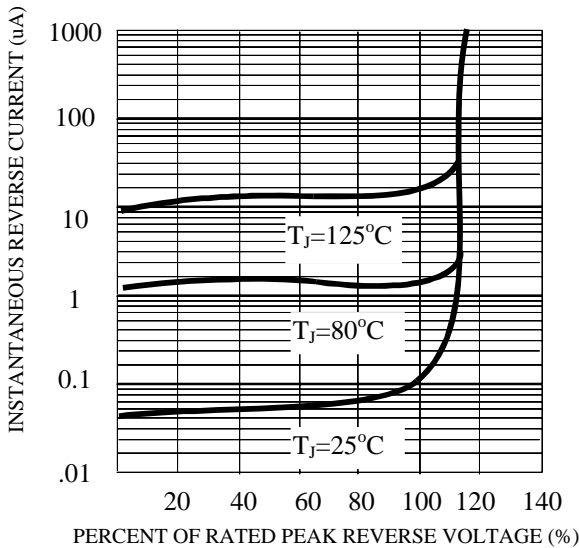

FIG. 4-TYPICAL INSTANTANEOUS FORWARD CHARACTERISTICS

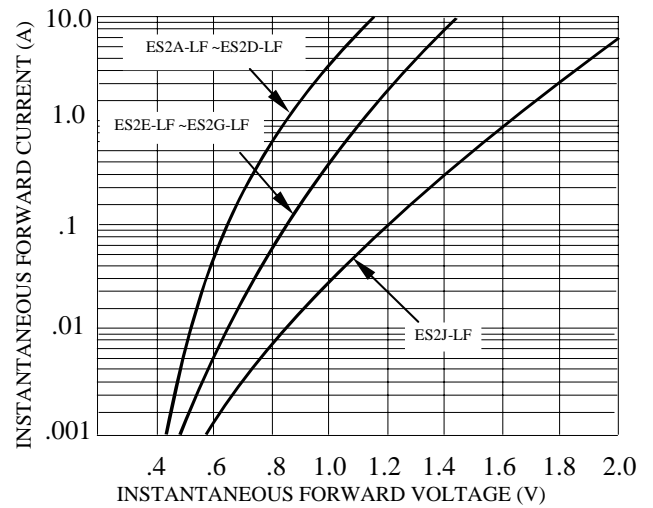

FIG. 5-MAXIMUM NON-REPETITIVE FORWARD SURGE CURRENT

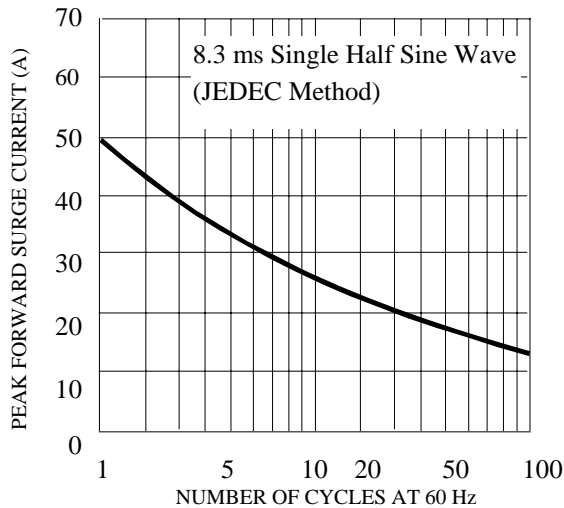

FIG. 6-TYPICAL JUNCTION CAPACITANCE

