



Micro Commercial Components

Micro Commercial Components  
 20736 Marilla Street Chatsworth  
 CA 91311  
 Phone: (818) 701-4933  
 Fax: (818) 701-4939

# DTC144ECA

## NPN Digital Transistors

### Features

- Case Material: Molded Plastic. UL Flammability Classification Rating 94V-0 and MSL Rating 1
- Built-in bias resistors enable the configuration of an inverter circuit without connecting external input resistors
- The bias resistors consist of thin-film resistors with complete isolation to allow negative biasing of the input. They also have the advantage of almost completely eliminating parasitic effects.
- Only the on/off conditions need to be set for operation, making device design easy

### Absolute maximum ratings @ 25°C

Symbol	Parameter	Min	Typ	Max	Unit
$V_{CC}$	Supply voltage	---	50	---	V
$V_{IN}$	Input voltage	-10	---	40	V
$I_O$	Output current	---	100	---	mA
$P_d$	Power dissipation	---	200	---	mW
$T_j$	Junction temperature	---	150	---	°C
$T_{stg}$	Storage temperature	-55	---	150	°C

### Electrical Characteristics @ 25°C

Symbol	Parameter	Min	Typ	Max	Unit
$V_{I(off)}$	Input voltage ( $V_{CC}=5V, I_O=100\mu A$ )	---	---	0.5	V
$V_{I(on)}$		3.0	---	---	V
$V_{O(on)}$	Output voltage ( $I_O/I_I=10mA/0.5mA$ )	---	---	0.3	V
$I_I$	Input current ( $V_I=5V$ )	---	---	0.18	mA
$I_{O(off)}$	Output current ( $V_{CC}=50V, V_I=0$ )	---	---	0.5	$\mu A$
$G_I$	DC current gain ( $V_O=5V, I_O=5mA$ )	68	---	---	
$R_1$	Input resistance	32.9	47	61.1	K $\Omega$
$R_2/R_1$	Resistance ratio	0.8	1.0	1.2	
$f_T$	Transition frequency ( $V_{CE}=10V, I_E=5mA, f=100MHz$ )	---	250	---	MHz

#### Equivalent circuit

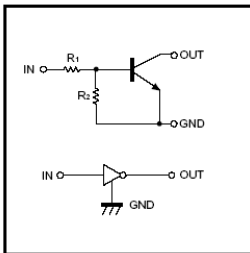

\*Marking: 26

### SOT-23

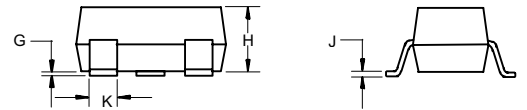
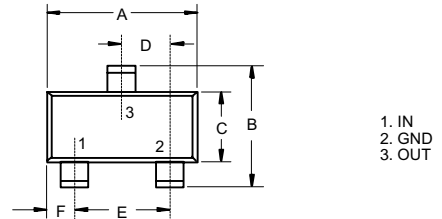

DIM	INCHES		MM		NOTE
	MIN	MAX	MIN	MAX	
A	.110	.120	2.80	3.04	
B	.083	.098	2.10	2.64	
C	.047	.055	1.20	1.40	
D	.035	.041	.89	1.03	
E	.070	.081	1.78	2.05	
F	.018	.024	.45	.60	
G	.0005	.0039	.013	.100	
H	.035	.044	.89	1.12	
J	.003	.007	.085	.180	
K	.015	.020	.37	.51	

### Suggested Solder Pad Layout

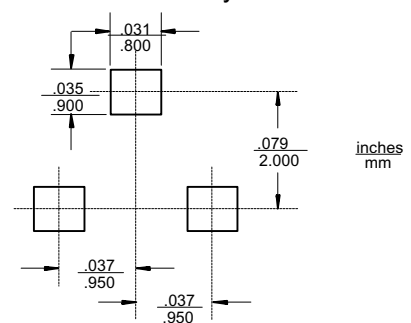

# DTC144ECA



Micro Commercial Components

## ● Electrical characteristic curves

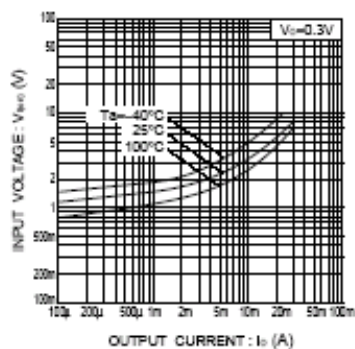

Fig.1 Input voltage vs. output current (ON characteristics)

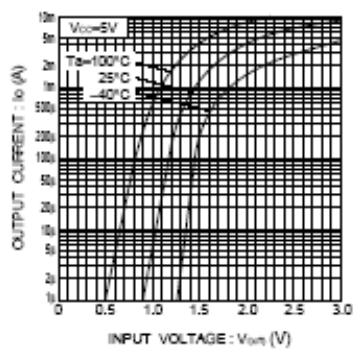

Fig.2 Output current vs. input voltage (OFF characteristics)

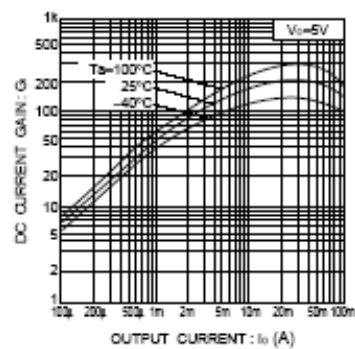

Fig.3 DC current gain vs. output current

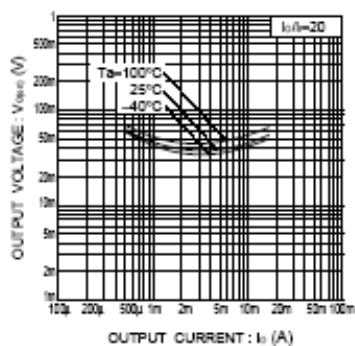

Fig.4 Output voltage vs. output current



Micro Commercial Components

## Ordering Information

Device	Packing
(Part Number)-TP	Tape&Reel;3Kpcs/Reel

### \*\*\*IMPORTANT NOTICE\*\*\*

*Micro Commercial Components Corp.* reserves the right to make changes without further notice to any product herein to make corrections, modifications, enhancements, improvements, or other changes. *Micro Commercial Components Corp.* does not assume any liability arising out of the application or use of any product described herein; neither does it convey any license under its patent rights, nor the rights of others. The user of products in such applications shall assume all risks of such use and will agree to hold *Micro Commercial Components Corp.* and all the companies whose products are represented on our website, harmless against all damages.

### \*\*\*APPLICATIONS DISCLAIMER\*\*\*

Products offer by *Micro Commercial Components Corp.* are not intended for use in Medical, Aerospace or Military Applications.

[www.mccsemi.com](http://www.mccsemi.com)