

DESCRIPTION

The LX1971 is a new technology light sensor with spectral response that emulates the human eye; it is pin to pin compatible to Microsemi's LX1970 visible light sensor however with a wider dynamic range.

This device is ideal for monitoring ambient light for the control of artificial lighting, operation of shades, LED signage and display, street lighting, automotive light sensors and control of backlight dimming. It has a unique photo diode arrangement (patents pending) with a peak response at 520nm while sharply attenuating both ultra violet and infrared wavelengths.

The photo sensor is a PIN diode array with an accurate and very repeatable current output.

Photo current is first multiplied by an integrated high gain amplifier then the square root is taken of the product of the amplifier and an internal reference current. Finally this is further multiplied converted to current and made available at two output pins; one a current source and the other a current sink.

These currents can easily be converted to voltage by adding a single resistor at either or both outputs. Voltage gain is determined by the resistor value typically in the 5K Ω to 50K Ω range.

With accurate internal gain amplifiers and square root transfer function, design complexity and cost are greatly reduced.

The LX1971 is available in the Clear 8-pin MSOP package.

IMPORTANT: For the most current data, consult MICROSEMI's website: <http://www.microsemi.com>
 Protected By U.S. Patents: 6,787,757; Patents Pending

KEY FEATURES

- Approximate Human Eye Spectral Response
- Low IR Sensitivity
- Highly Accurate & Repeatable Output Current vs. Light
- Square root transfer function
- Temperature Stable
- Integrated High Gain Photo Current Amplifiers
- Complementary Current Outputs
- No Optical Filters Needed

BENIFITS

- Requires no wavelength filters
- Insensitive to UV and IR
- More than 4 decades usable light range
- Enables accurate lighting control systems

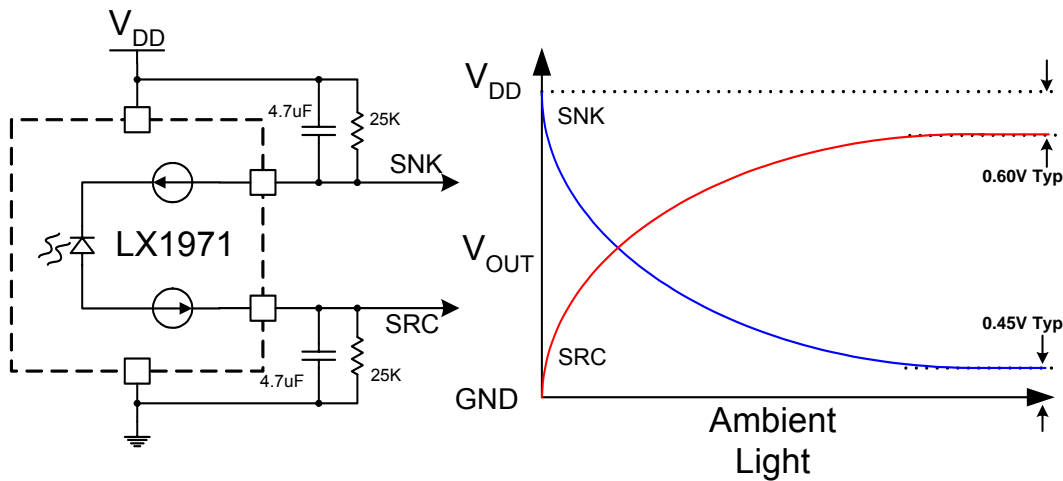
PRODUCT HIGHLIGHT

PACKAGE ORDER INFO

T_A (°C)	DU Plastic MSOP
	8-Pin
	RoHS Compliant / Pb-free
-40 to 85	LX1971IDU

Note: Available in Tape & Reel. Append the letters "TR" to the part number. (i.e. LX1971IDU-TR)

ABSOLUTE MAXIMUM RATINGS

V_{DD}	-0.3 to 6 V_{DC}
SNK/SRC (Output Compliance Voltage).....	-0.3 to $V_{DD} + 0.3V_{DC}$
SNK/SRC (Maximum Output Current).....	Internally Limited
Operating Temperature Range	-40 to +85°C
Storage Temperature Range	-40 to +100°C
Solder Reflow Peak Temperature (Soldering 10 seconds).....	240°C

Notes: Exceeding these ratings could cause damage to the device. All voltages are with respect to Ground. Currents are positive into, negative out of specified terminal.

Solder reflow to follow: IPC/JEDEC J-STD-020B 7/02 Pb-SN Small Body Profile

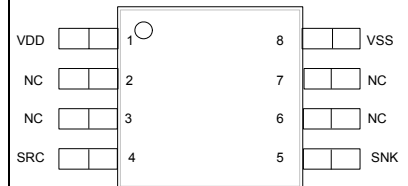
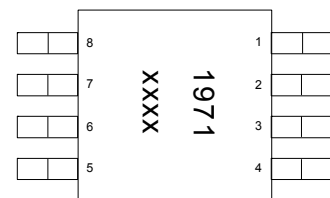
PACKAGE PIN OUT

DU PACKAGE
 (Top View)

DU PACKAGE
 (Bottom View)

xxxx = Denotes Date Code / Lot Information

RoHS / Pb-free Gold Lead Finish
 MSL 2 / 260°C / 1 Year

THERMAL DATA
DU Plastic MSOP 8-Pin

THERMAL RESISTANCE-JUNCTION TO AMBIENT, θ_{JA}	206°C/W
THERMAL RESISTANCE-JUNCTION TO CASE, θ_{JC}	39°C/W

FUNCTIONAL PIN DESCRIPTION

NAME	DESCRIPTION
V_{DD}	Input Supply Voltage
V_{SS}	Ground Reference for Power and Signal Output
SNK	Output Current Sink
SRC	Output Current Source

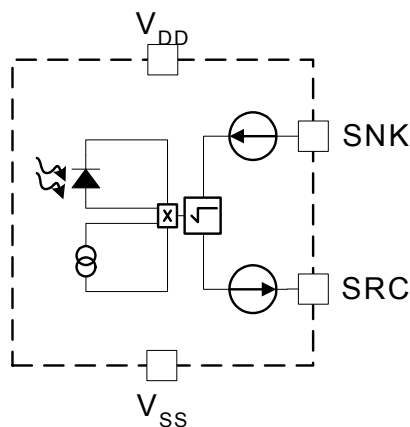
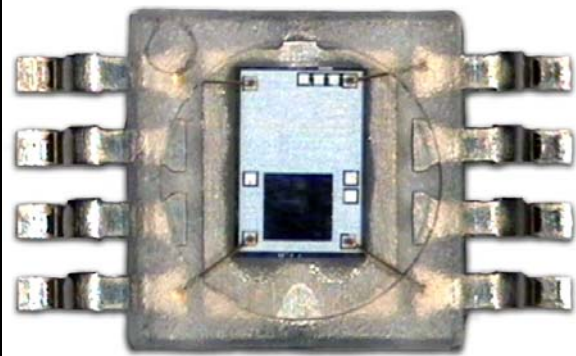
SIMPLIFIED BLOCK DIAGRAM

PACKAGE PHOTO

RECOMMENDED OPERATING CONDITIONS

Parameter	LX1971			Units
	Min	Typ	Max	
Supply Voltage (V_{DD})	3 ¹		5.5	V
SNK Compliance Voltage Range	$V_{SS} + 0.6$		V_{DD}	V
SRC Compliance Voltage Range	V_{SS}		$V_{DD} - 0.75$	V
SNK/SRC Output Resistor Range	5		100	K Ω

¹Outputs are functional down to $V_{DD}=2.7V$
ELECTRICAL CHARACTERISTICS

Unless otherwise specified, the following specifications apply over the operating ambient temperature $-40^{\circ}C \leq T_A \leq 85^{\circ}C$, $V_{DD} = 3V$ to $5.5V$, $R_{LOAD} = 25K\Omega$, Direct Light Input² of $584\mu W/cm^2$ except where otherwise noted. Performance between $-40^{\circ}C$ and $0^{\circ}C$ and between $70^{\circ}C$ and $85^{\circ}C$ are assured by design and characterization.

Parameter	Symbol	Test Conditions	LX1971			Units
			Min	Typ	Max	
Supply Voltage Range	V_{DD}		3		5.5	V_{DC}
Input Supply Current	I_{DD}	$V_{DD} = 3.0V$, $I_{SRC} = 62\mu A$, $I_{SNK} = \text{open}$	350	590	750	μA
Output Current	I_{SRC}	$V_{DD} = 3.0V$, Direct Light Input of $584\mu W/cm^2$ @ $25^{\circ}C$	55	61	67	μA
	I_{SRC}	$V_{DD} = 3.0V$, Direct Light Input of $584\mu W/cm^2$	52	61	70	
	I_{SNK}	$V_{DD} = 3.0V$, Direct Light Input of $584\mu W/cm^2$	-70	-61	-52	μA
	I_{SRC}	$V_{DD} = 3.0V$, Direct Light Input of $292\mu W/cm^2$	34	41	48	μA
	I_{SRC}	$V_{DD} = 3.0V$, Direct Light Input of $9.34\mu W/cm^2$	5.5	7	8.5	μA
Output SNK/SRC Current Matching	I_{MATCH}	$V_{DD} = 3.0V$		2	6	%
SNK Minimum Compliance Voltage	SNK_{VMIN}	$V_{DD} = 3.0V$, @ 95% of nominal output current		$V_{SS} + 0.45$	$V_{SS} + 0.6$	V
SRC Maximum Compliance Voltage	SRC_{VMAX}	$V_{DD} = 3.0V$, @ 95% of nominal output current		$V_{DD} - 0.6$	$V_{DD} - 0.7$	V
SNK/SRC Output Dark Current	$I_{DARK3.0V}$	$V_{DD} = 3V$, No Light, $25^{\circ}C$		150	400	nA
SNK/SRC Output Dark Current	$I_{DARK3.0V}$	$V_{DD} = 3V$, No Light, $-40^{\circ}C$ to $70^{\circ}C$		450	1000	nA
SNK/SRC Output Dark Current	$I_{DARK3.0V}$	$V_{DD} = 3V$, No Light, $85^{\circ}C$		550	1150	nA
SNK/SRC Output Dark Current	$I_{DARK5.5V}$	$V_{DD} = 5.5V$, No Light, $25^{\circ}C$		320		nA
Wavelength of Peak Sensitivity	λ_{PS}			520		nm
Half Reception Angle	$\theta_{\frac{1}{2}}$			± 60		deg
Supply Voltage Coefficient of Output Current	PSRR	$V_{DD} = 3V$ to $5.5V$		2.9	3.5	%/V
Resolution Limit Due To Random Noise	I_{MIN}	Minimum usable resolution		146		nW/cm ²
Sensitivity Change @ 910nm	$I_{SRC}\Delta IR$	Current responsivity change with additional direct light input of $584\mu W/cm^2$ at 910nm, $T_A = 25^{\circ}C$, $V_{DD} = 3V$	-10	0	10	% of peak
Radiant Sensitive Area	A	Photodiode Area		.369		mm ²

²The input irradiance is supplied from a white light-emitting diode (LED) optical source adjusted to impose $584\mu W/cm^2$ at 555nm on the sensor's surface.

APPLICATION INFORMATION

The LX1971 is a light sensor with a spectral response that resembles the human visual system. It is packaged in clear MSOP package with the same pin out and same supply voltage range as Microsemi's LX1970 light sensor. The LX1971 responsiveness however differs from that of the LX1970. In general the LX1971 has lower sensitivity and a wider dynamic range.

Whereas the LX1970 has a responsiveness that is directly proportional to the intensity of light falling on the photo receptors. There are two different response equations for the LX1971 depending on the operating range (intensity of the light). Below 2500 lux, the response resembles a square root function. Above 2500 lux, the response fits a straight line curve.

$$I_{OUT} = (\sqrt{L} \times .808) + 1.1\mu A \text{ for } L < 2500 \text{ lux}$$

$$I_{OUT} = (L \times .0083\mu A) + 23\mu A \text{ for } 2500 \text{ lux} < L < 20000 \text{ lux}$$

The LX1970 is best suited for applications where the light sensor is an integral part of a continuous lighting control system. For example, in an LCD backlighting application, the level of brightness of the backlight should be adjusted in proportion to the level of ambient lighting; the LX1970 can provide closed loop brightness control for this type of system. For most indoor applications, the 2500 lux saturation point of the LX1970 is usually not a limiting affect.

The LX1971 is best suited for applications where the system must respond to external events that affect the user's ability to see clearly. For example, a sensor to turn on headlights or a sensor to adjust the reflectivity of a rear view mirrors. These systems require the sensor to have dynamic range similar to sight. Like the human eye, the square root function of the LX1971 makes it extra sensitive to small changes at lower light levels. The wide dynamic range allows the LX1971 to sense the difference between twilight and daylight or sunshine and heavy cloud cover.

The following curves show the calculated responsiveness of the LX1971 without load resistors based on the formulas above. They can be used as baseline guidelines to calculate gain setting resistors. The compliance of the current source output may result in premature saturation of the output when load resistors are added. The SRC compliance voltage is specified typically at VDD-600mV @ about 4000 lux.

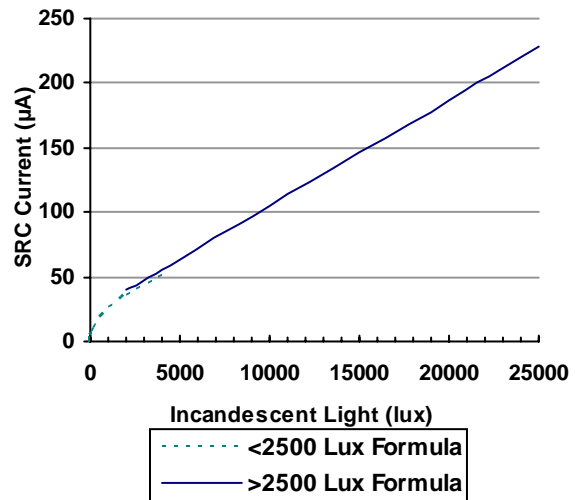
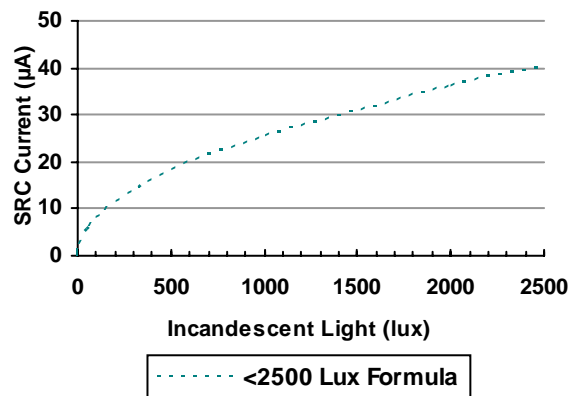
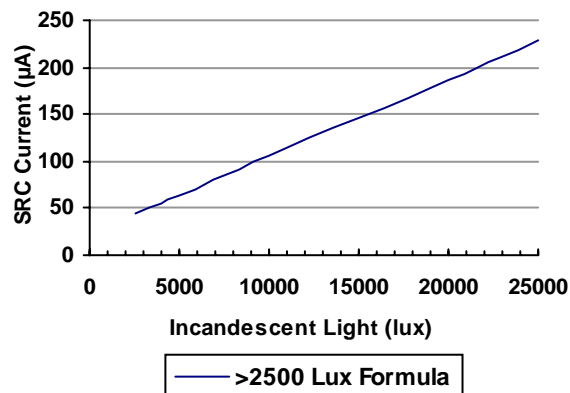
LX1971 Calculated SRC Full Range Response

LX1971 Calculated SRC Low Level Response

LX1971 Calculated SRC High Level Response

APPLICATION EXAMPLES

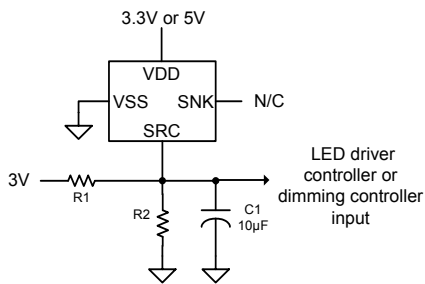
The following examples present both fully automatic (no user input) and semi-automatic, to fully manual override implementations. These general guidelines are applicable to a wide variety of potential light control applications. The LX1971 can be used for the control of artificial lighting, operation of shades, LED signage and display, street lighting, automotive light sensors and control of backlight dimming.

In each specific application it is important to recognize the need to correlate the sink and source current of the LX1971 for the target environment and its ambient light conditions. The mechanical mounting of the sensor, light aperture hole size, use of a light pipe or bezel are critical in determining the response of the LX1971 for a given exposure of light.

Figure 1

The example in figure one shows a fully automatic lighting control solution with no user interaction. Choose R1 and R2 values for any desired minimum brightness and slope. Choose C1 to adjust response time. As an example, let's say you wish to generate an output voltage from 0.25V to 1.25V to drive the input of an LED driver controller. The 0.25V represents the minimum LED brightness and 1.25V represent the maximum. The first step would be to determine the ratio of R1 and R2.

$$R1 = R2 [3.0V / 0.25V - 1] = 11 * R2$$

Next the value of R2 can be calculated based on the maximum output source current coming from the LX1971 under the application's maximum light exposure, let's say this has been determined to be about 50µA. Thus R2 can be calculated first order as follows:

$$R2 = [1.25V / 50\mu A] = 25K\Omega \therefore R1 = 11 * R2 = 275K\Omega$$

The output node will actually reach 1.25V when the source current from the LX1971 is only about 44µA since about 6µA of current will be contributed from R1.

We are assuming a high impedance input to the LED driver. In Figure 2 user adjustable bias control has been added to allow control over the minimum and maximum output voltage. This allows the user to adjust the output brightness to personal preference over a limited range. The PWM input source could of course be replaced with an equivalent DC voltage.

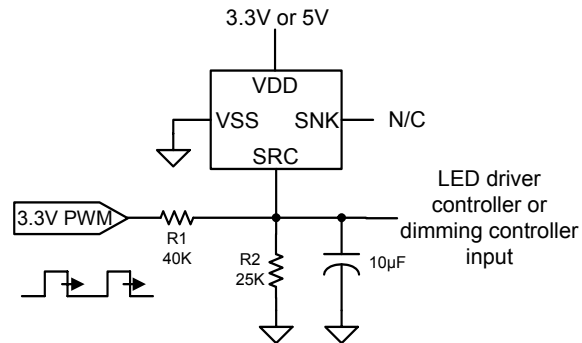
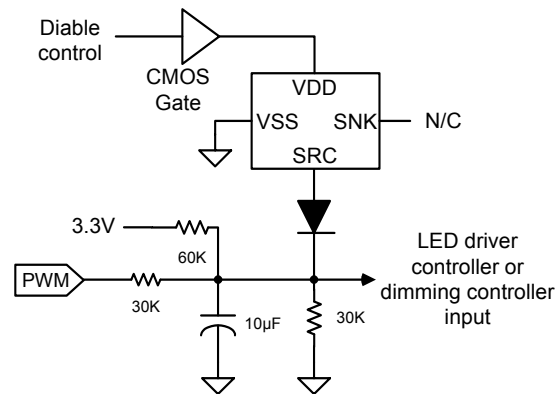
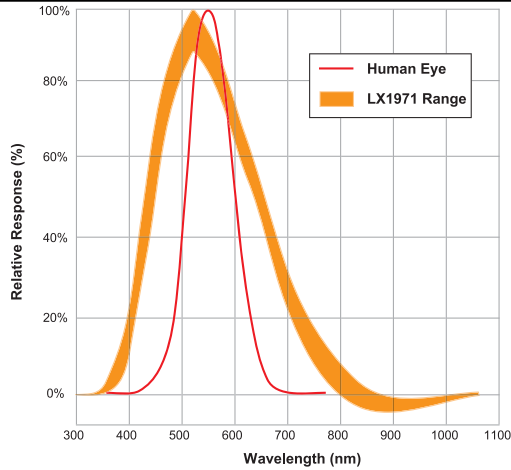

Figure 2

Figure 3 shows how a fully manual override can be quickly added to the example in figure 2. In addition to the gate to turn on and off the LX1971, a diode has been inserted to isolate the LX1971 when it is shut down.

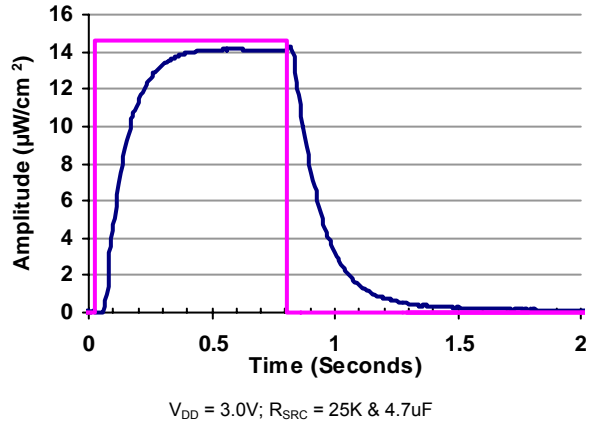

Figure 3

The preceding examples represent just a few of the many ways the sensor can be used. For example since there is also a complimentary sink output a resistor from VDD to SNK could develop a voltage that could be compared (with some hysteresis) to a fixed (or adjustable) reference voltage and develop a logic signal. In the case of street lighting or operation of shades such a signal would engage the function when reaching the correct ambient light level.

RESPONSE VS WAVELENGTH



I_{SRC} STEP RESPONSE



LINE REGULATION

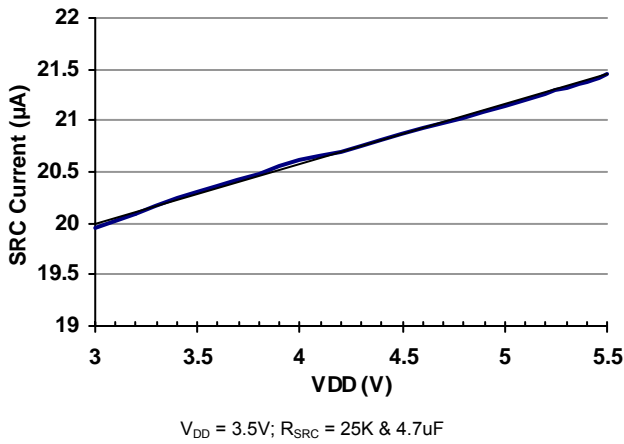

DARK CURRENT VS TEMP

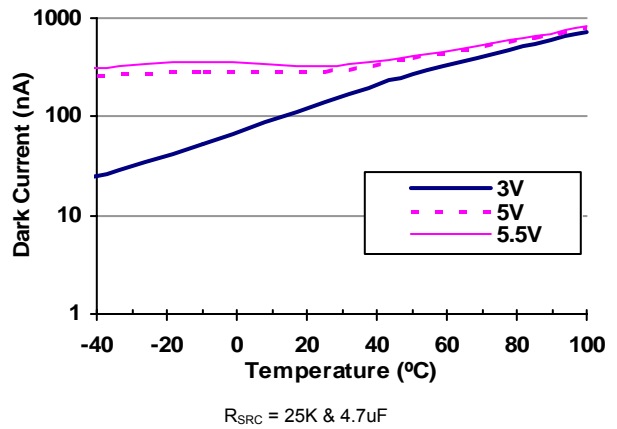

SNK OUTPUT PSRR

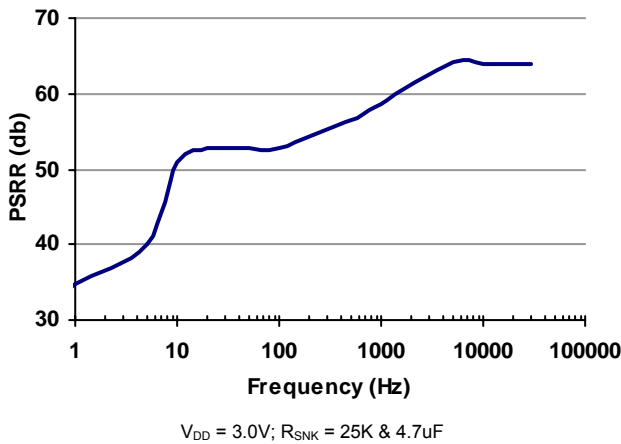

GAIN VS TEMP

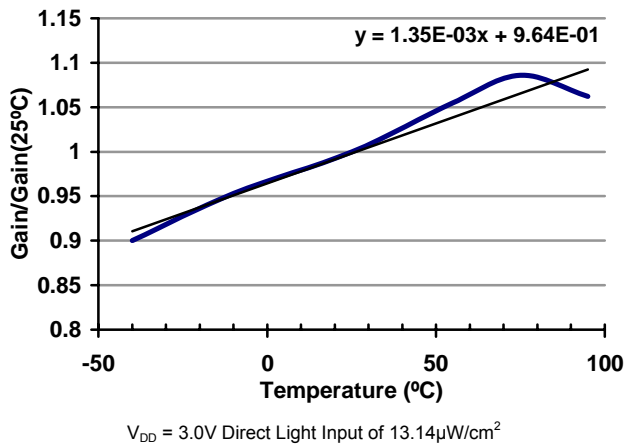

SNK COMPLIANCE VS CURRENT

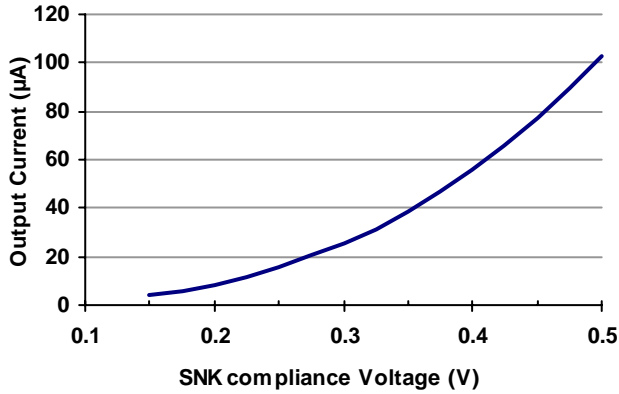

$V_{DD} = 3.0V$; $R_{SNK} = 25K \ \& \ 4.7\mu F$

SRC COMPLIANCE VS CURRENT

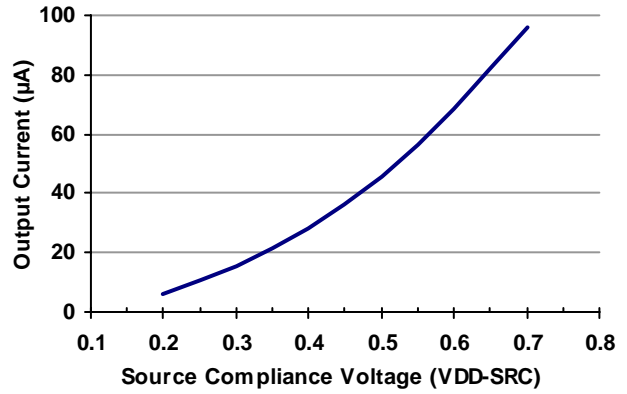

$V_{DD} = 3.0V$; $R_{SRC} = 25K \ \& \ 4.7\mu F$

SRC OUTPUT VS LUMINANCE(LUX)

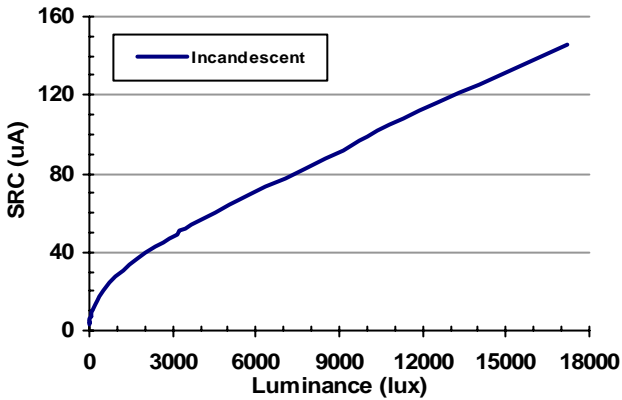

$V_{DD} = 4.0V$; $R_{SNK} = 10K \ \& \ 4.7\mu F$

SRC OUTPUT VS LUMINANCE(LUX)

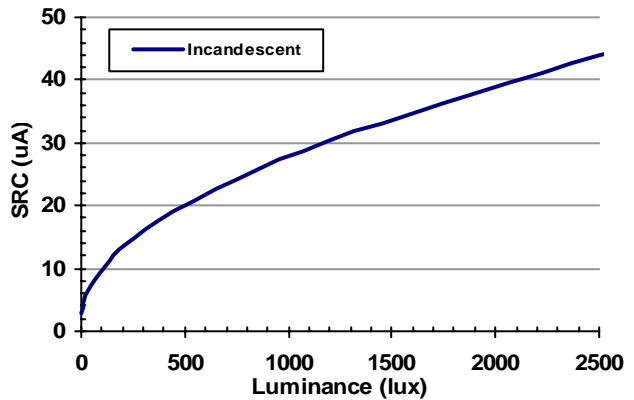

$V_{DD} = 4.0V$; $R_{SNK} = 10K \ \& \ 4.7\mu F$

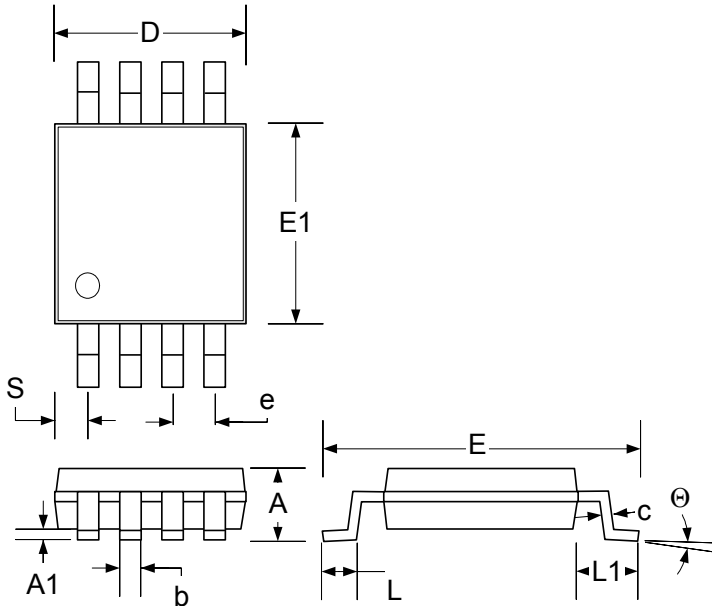
PACKAGE DIMENSIONS
DU 8-Pin Miniature Shrink Outline Package (MSOP)

Dim	MILLIMETERS		INCHES	
	MIN	MAX	MIN	MAX
A	–	1.10	–	0.043
A1	0.05	0.15	0.002	0.006
b	0.26	0.41	0.010	0.016
c	0.13	0.23	0.005	0.009
D	2.90	3.10	0.114	0.122
e	0.65 BSC		0.025 BSC	
E	4.75	5.05	0.187	0.198
E1	2.90	3.10	0.114	0.122
L	0.41	0.71	0.016	0.028
L1	0.95 BSC		0.037 BSC	
S	0.525 BSC		0.021 BSC	
θ	3°		3°	

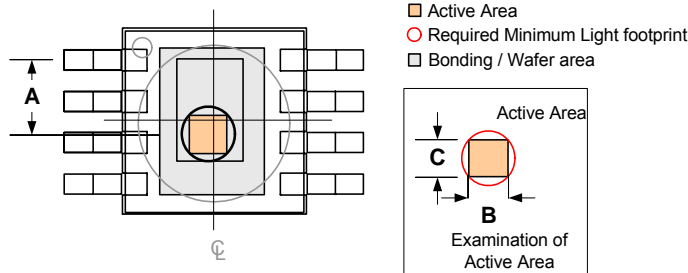

Dim	MILLIMETERS	INCHES
A	1.22	0.048
B	0.60	0.024
C	0.60	0.024
P1	2.5	0.98

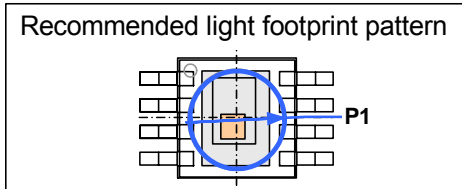
Note:

P1 represents a possible light footprint and its dimensions are not subject to strict tolerances. Only the active area of the device is required to be covered with light. This larger footprint is designed to ensure coverage of the device's active area.

NOTES

PRODUCTION DATA – Information contained in this document is proprietary to Microsemi and is current as of publication date. This document may not be modified in any way without the express written consent of Microsemi. Product processing does not necessarily include testing of all parameters. Microsemi reserves the right to change the configuration and performance of the product and to discontinue product at any time.