

Silicon PNP RF Transistor

Applications: UHF/VHF high current input and mixer stages

Features:

- High cross modulation performance
- High power gain
- Low noise
- High reverse attenuation

Dimensions in mm

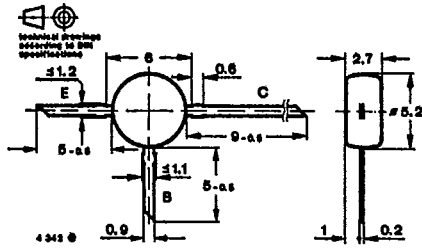

Plastic case
≈ JEDEC TO 50
Weight max. 0.25 g

Absolute maximum ratings

Collector-base voltage	$-V_{CBO}$	20	V
Collector-emitter voltage	$-V_{CEO}$	20	V
Emitter-base voltage	$-V_{EBO}$	3	V
Collector current	$-I_C$	50	mA
Base current	$-I_B$	5	mA
Total power dissipation $T_{amb} \leq 55^\circ C$	P_{tot}	160	mW
Junction temperature	T_j	150	$^\circ C$
Storage temperature range	T_{stg}	-55 ... +150	$^\circ C$

Thermal resistance

Junction ambient	R_{thJA}	Min.	Typ.	Max.	600	K/W
------------------	------------	------	------	------	-----	-----

T1.2/542.0484 E1

BF 479 T · (S 479 T)

T-31-15

DC characteristics

		Min.	Typ.	Max.
$T_{amb} = 25\text{ °C}$, unless otherwise specified				
Collector cut-off current $-V_{CB} = 16\text{ V}$	$-I_{CBO}$			100 nA
Collector-base breakdown voltage $-I_C = 10\text{ }\mu\text{A}$	$-V_{(BR)CBO}$	20		V
Collector-emitter breakdown voltage $-I_C = 2\text{ mA}$	$-V_{(BR)CEO}^{1)}$	20		V
Emitter-base breakdown voltage $-I_E = 10\text{ }\mu\text{A}$	$-V_{(BR)EBO}$	3		V
DC forward current transfer ratio $-V_{CB} = 10\text{ V}, -I_C = 10\text{ mA}$	h_{FE}	20		

AC characteristics

$T_{amb} = 25\text{ °C}$				
Gain bandwidth product $-V_{CB} = 10\text{ V}, -I_C = 8\text{ mA}, f = 300\text{ MHz}$	f_T		1850	MHz
Collector-base capacitance $-V_{CB} = 10\text{ V}, f = 100\text{ MHz}$	C_{CBO}		0.5	pF
Noise figure $-V_{CB} = 10\text{ V}, -I_C = 10\text{ mA}, R_G = 50\text{ }\Omega,$ $f = 800\text{ MHz}$	$F_b^{2)}$		4.5	6.0 dB
Power gain $-V_{CB} = 10\text{ V}, -I_C = 10\text{ mA}, f = 800\text{ MHz},$ $R_G = 50\text{ }\Omega, R_L = 500\text{ }\Omega$	$G_{pb}^{2)}$	13	14.5	dB
Collector current for $G_{pb\text{ max}}$ $-V_{CB} = 10\text{ V}, f = 800\text{ MHz},$ $R_L = 500\text{ }\Omega$	$I_C^{2)}$	8.0	10.5	mA

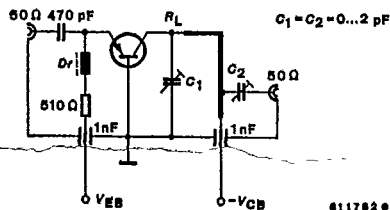

Test circuit for: G_{pb}, F_b

¹⁾ $\frac{f_D}{f} = 0.01, t_p = 0.3\text{ ms}$, ²⁾ see test circuit

BF 479 T · (S 479 T)

7-31-15

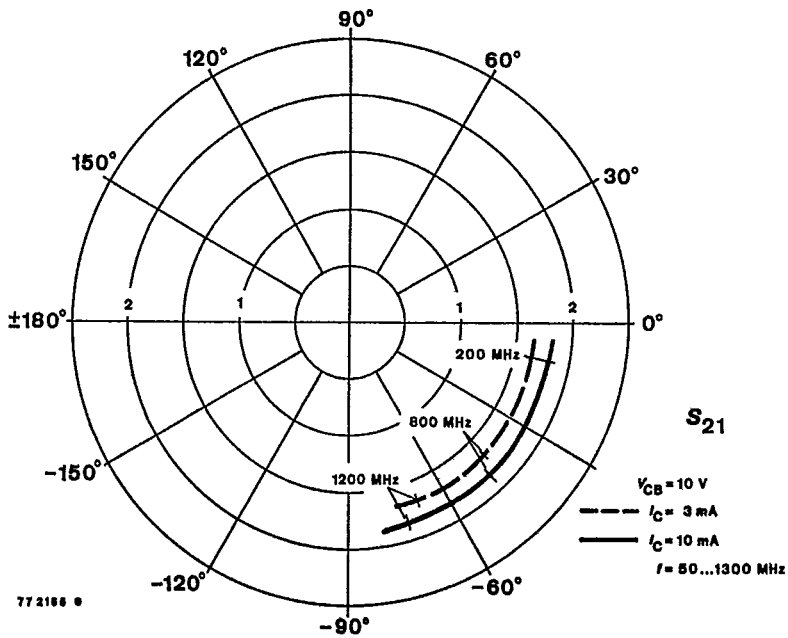
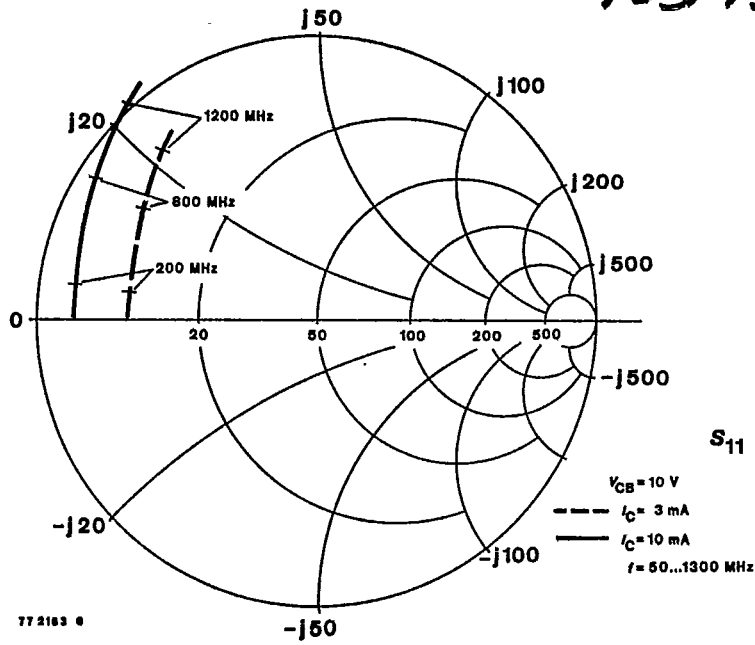

BF 479 T · (S 479 T)

7-31-15

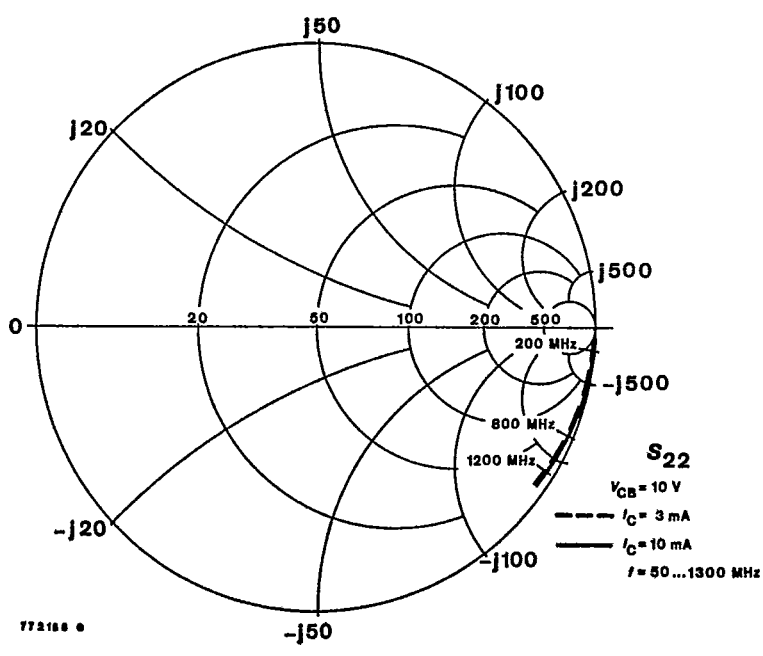
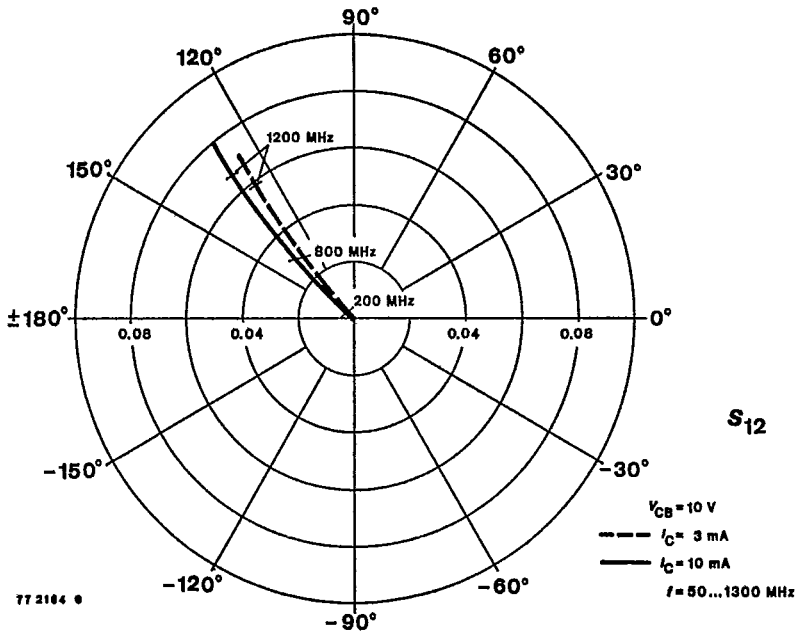

7. Taping and Reeling

T-91-20

7.1. Taping of TO-92 Transistors

Standard reeling: Taped on reel, reeled together with a paper film.

7.1.1. Order Numbers

Add the taping-code to the order number.

Example:

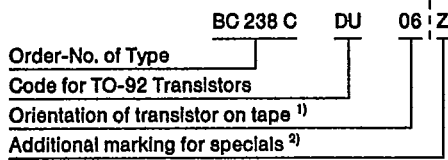

- ¹⁾ 06 = View on flat side of transistor, view on gummed tape
- 05 = View on round side of transistor, view on gummed tape

- ²⁾ Additional marking "0": taping without paper film
- Additional marking "Z": Zigzag folded tape in special box. Marking for orientation of transistor not necessary, because box can be opened on top or bottom

Example for order No.: BC 237 C DU Z

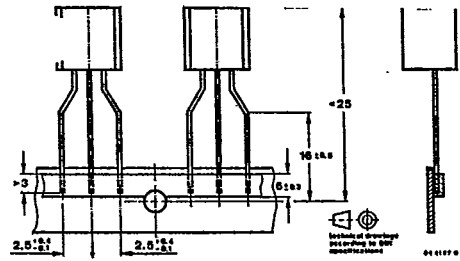

Fig. 7.3 Dimensions of tape in mm

7.1.2 Quantity of devices

- 1 000 devices per reel
- 2 000 devices per folded tape in special box.

7.2. Taped transistors in SOT 23 and SOT 143 case

7.2.1. Designation

a) Standard taping

Designation is attached with code GS 08 in case of standard taping. Example for normal version transistors as standard taped: BF 569-GS 08.

Example for R-version transistors as standard taped: BF 569 R-GS 08.

In case of standard taping, the transistor orientation on the tape is shown in Fig. 7.4 and Fig. 7.5.

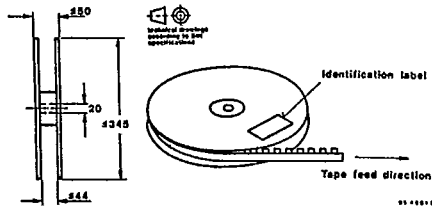

Fig. 7.1. Dimensions of reel in mm

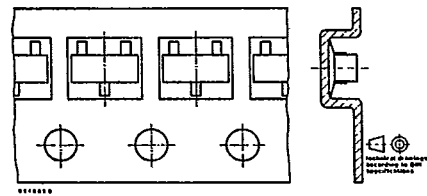

Fig. 7.4 Standard taped SOT 23

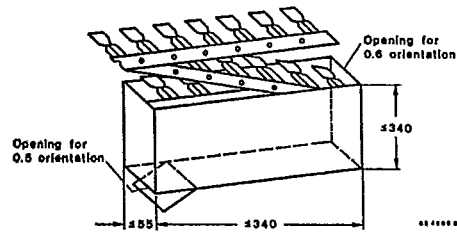

Fig. 7.2. Dimension of box for Zigzag folding in mm

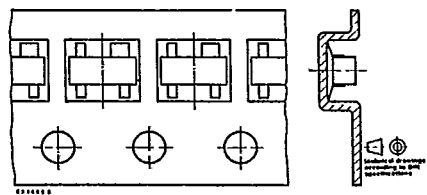

Fig. 7.5. Standard taped SOT 143

T-91-20

b) Reverse taping

Designation is attached with code GS07 in case of reverse taping. Example for normal version transistors as reverse taped: BF 569-GS 07.

Example for R-version transistors as reverse taping: BF 569 R-GS 07.

In case of reverse taping, the transistor orientation on the tape is shown in Fig. 7.6.

Regarding MOS-FET and MES-FET devices, reverse taping is at present not available.

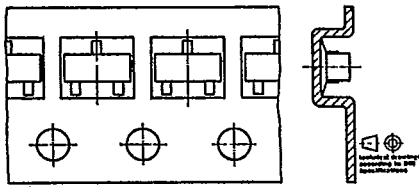

Fig. 7.6 Reverse taped SOT 23

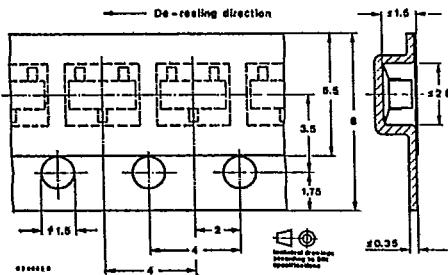

Fig. 7.7 Dimensions of tape in mm

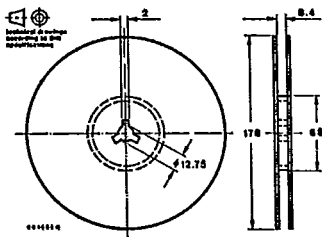

Fig. 7.8 Dimensions of reel in mm

7.2.2 Quantity of devices

3000 devices per reel