



LIGITEK ELECTRONICS CO.,LTD.
Property of Ligitek Only

LED SMD



LG-170RGB-CT

DATA SHEET

DOC. NO : QW0905-LG-170RGB-CT

REV. : A

DATE : 05 - Jan - 2005



Features:

- 1. Package in 8.0mm carrier tape on 7" diameter reel.
- 2. Compatible with automatic placement equipment.
- 3. Compatible with reflow solder process.

Descriptions:

- 1. The LG-170RGB SMD Taping is much smaller than lead frame type components, thus enable smaller board size, higher packing density, reduced storage space and finally smaller equipment to be obtained.
- 2. Besides, lightweight makes them ideal for miniature applications. etc.

Applications:

- 1. Automotive : backlighting in dashboard and switch.
- 2. Telecommunication : indicator and backlighting in telephone and fax.
- 3. Flat backlight for LCD, switch and symbol
- 4. General use.

Device Selection Guide:

PART NO	MATERIAL	COLOR	
		Emitted	Lens
LG-170RGB-CT	AlGaInP	Red	Water Clear
	InGaN/GaN	Green	
	InGaN/GaN	Blue	



Package Dimensions

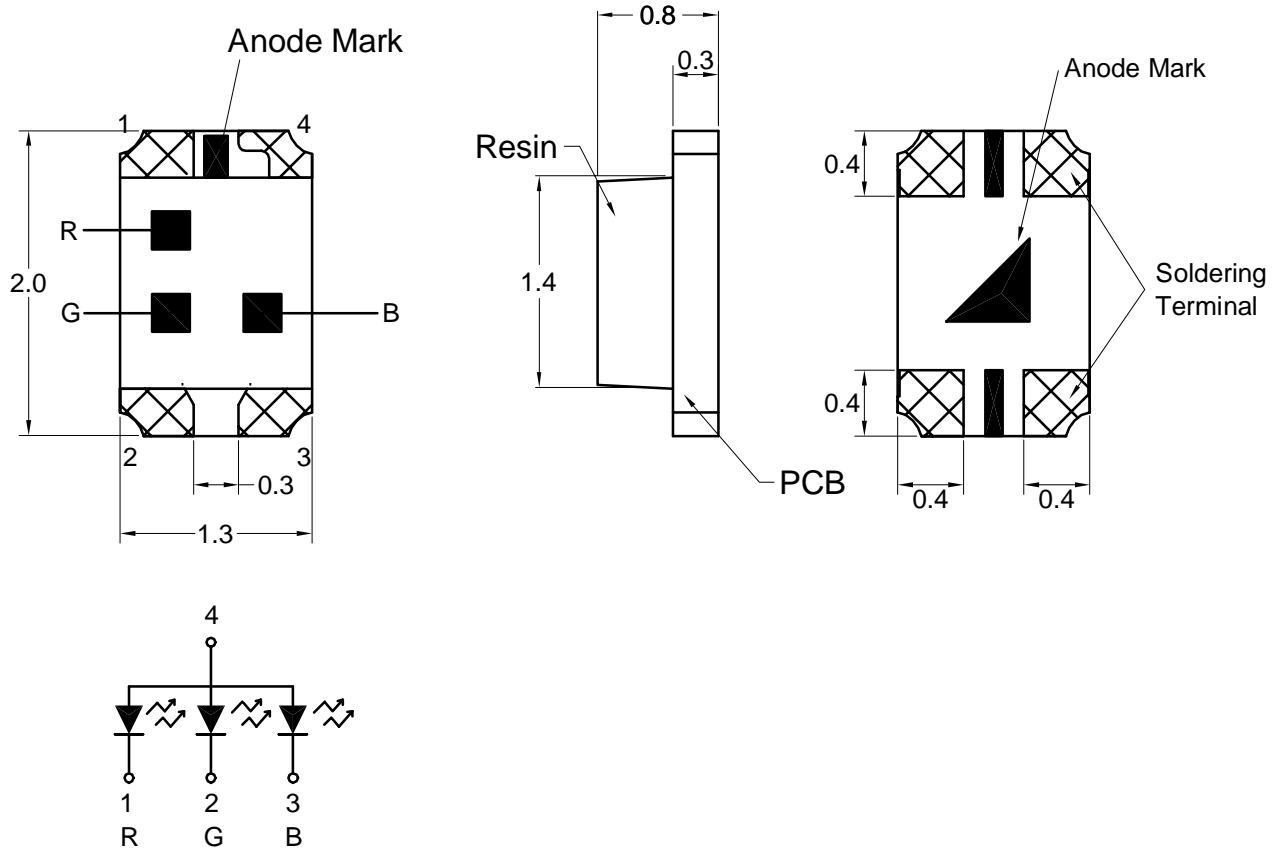

Note : 1.All dimension are in millimeter tolerance is $\pm 0.1\text{mm}$ unless otherwise noted.
2.Specifications are subject to change without notice.

Recommended Soldering Pad Dimensions

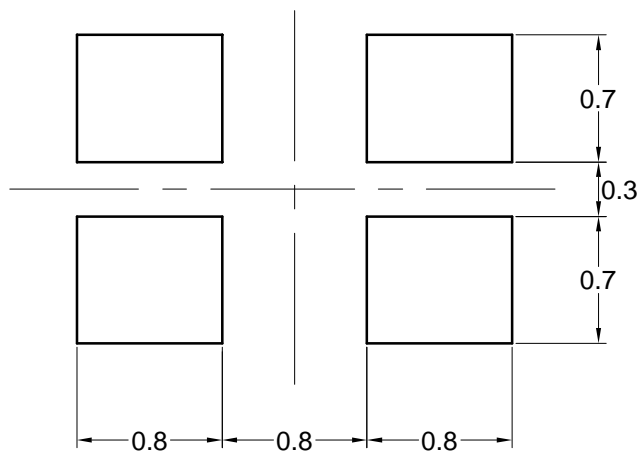

Note : The tolerances unless mentioned is $\pm 0.1\text{mm}$, Angle ± 0.5 . Unit=mm.

**Absolute Maximum Ratings at Ta=25**

Parameter	Symbol	Ratings			UNIT
		URF	DGM	DBK	
Power Dissipation	PD	72	80	80	mW
Peak Forward Current Duty 1/10@10KHz	IFP	130	100	100	mA
Forward Current	IF	30	20	20	mA
Reverse Current @5V	Ir	10	50	50	μ A
Electrostatic Discharge	ESD	2000	150		V
Operating Temperature	Topr	-40 ~ +85			
Storage Temperature	Tstg	-40 ~ +90			
Soldering Temperature	Tsol	Max 260 for 5 sec Max			



Typical Electrical & Optical Characteristics (Ta=25)

Items	Symbol	Min.	Typ.	Max.	UNIT	CONDITION	
Luminous Intensity	Iv	URF	32	100	----	mcd	IF=20mA
		DGM	80	250	----		
		DBK	32	80	----		
Peak Wavelength	P	URF	----	642	----	nm	IF=20mA
		DGM	----	518	----		
		DBK	----	465	----		
Dominant Wavelength	D	URF	----	630	----	nm	IF=20mA
		DGM	----	525	----		
		DBK	----	470	----		
Spectral Line Half-Width		URF	----	20	----	nm	IF=20mA
		DGM	----	36	----		
		DBK	----	30	----		
Forward Voltage	V _F	URF	1.5	----	2.4	V	IF=20mA
		DGM	----	3.5	4.0		
		DBK	----	3.5	4.0		
Viewing Angle	2 1/2	URF	----	130	----	deg	IF=20mA
		DGM	----	130	----		
		DBK	----	130	----		



Typical Electro-Optical Characteristics Curve URF CHIP

Fig.1 Forward current vs. Forward Voltage

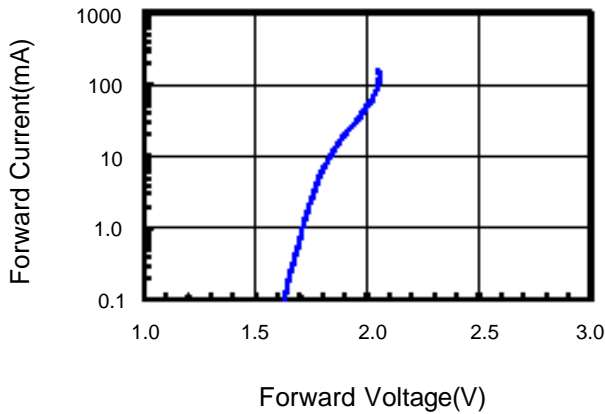

Fig.2 Relative Intensity vs. Forward Current

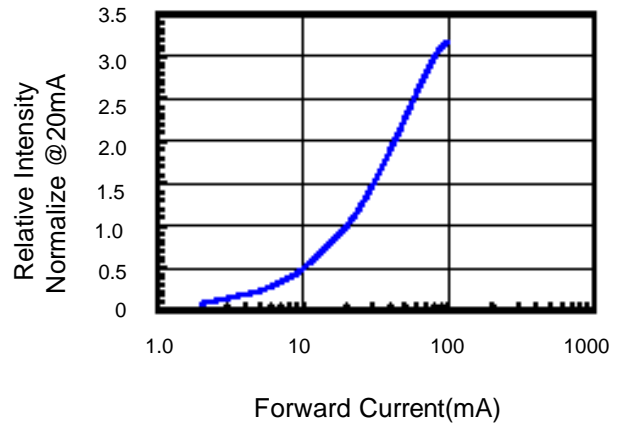

Fig.3 Forward Voltage vs. Temperature

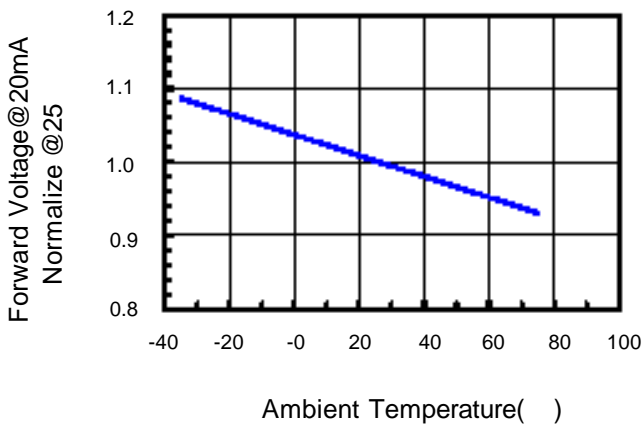

Fig.4 Relative Intensity vs. Temperature

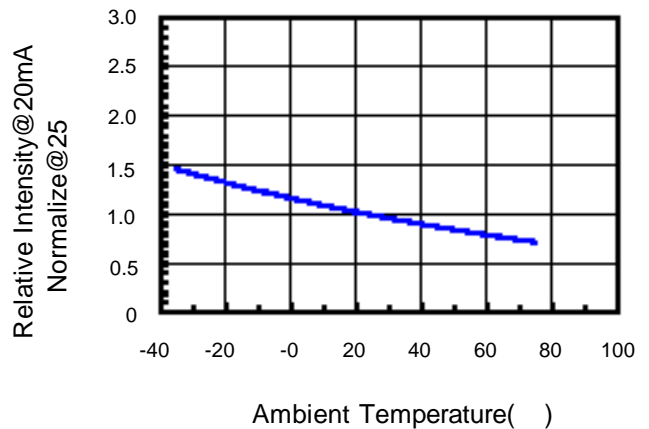

Fig.5 Relative Intensity vs. Wavelength

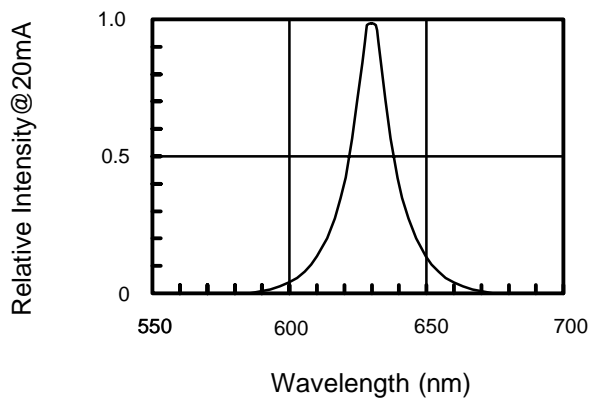
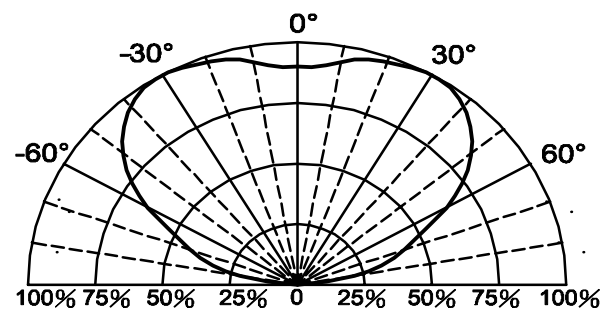

Fig.6 Directive Radiation





Typical Electro-Optical Characteristics Curve

DGM CHIP

Fig.1 Forward current vs. Forward Voltage

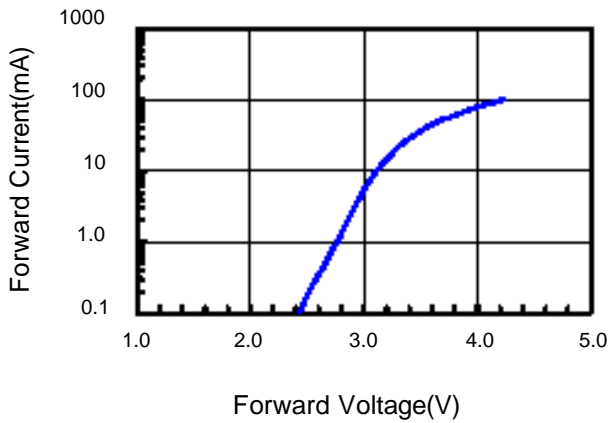

Fig.2 Relative Intensity vs. Forward Current

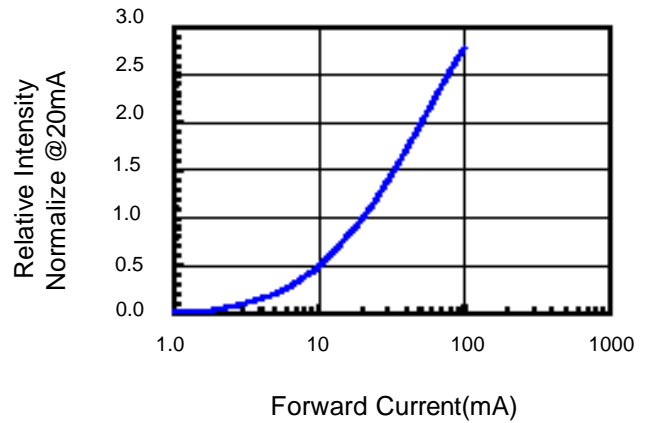

Fig.3 Forward Voltage vs. Temperature

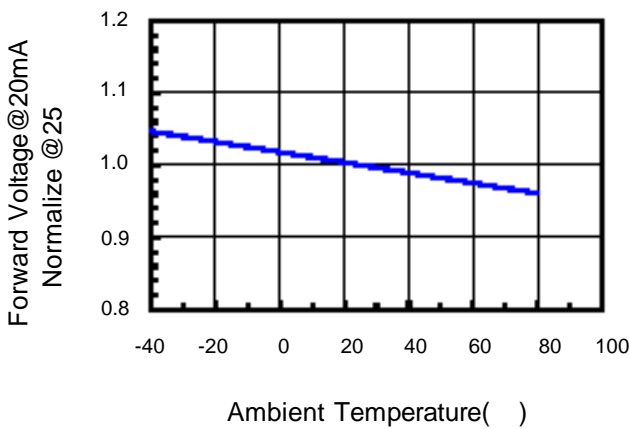

Fig.4 Relative Intensity vs. Temperature

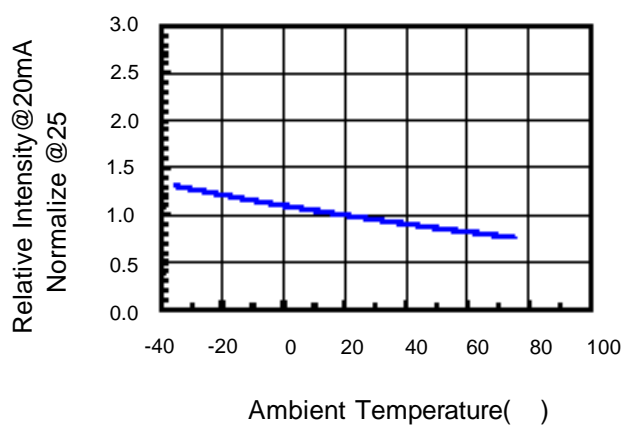

Fig.5 Relative Intensity vs. Wavelength

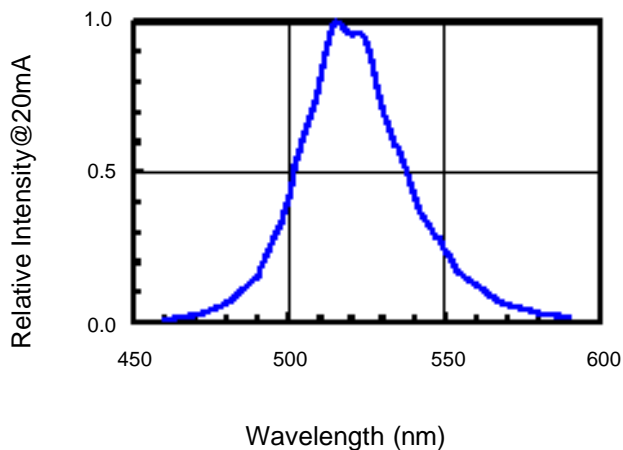
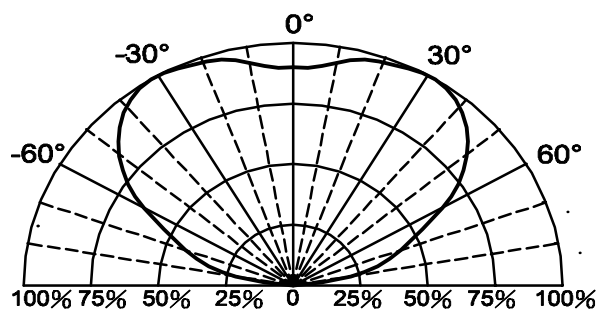

Fig.6 Directive Radiation





Typical Electro-Optical Characteristics Curve

DBK CHIP

Fig.1 Forward current vs. Forward Voltage

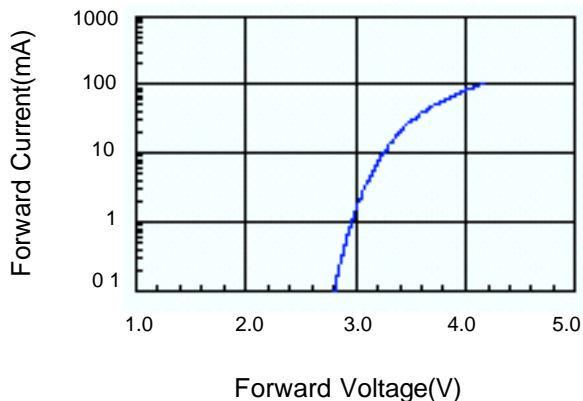

Fig.2 Relative Intensity vs. Forward Current

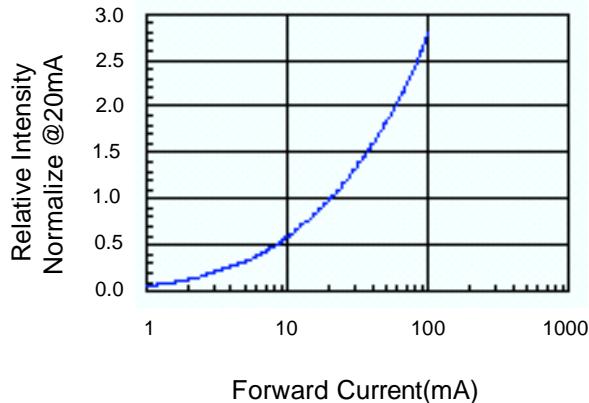

Fig.3 Forward Voltage vs. Temperature

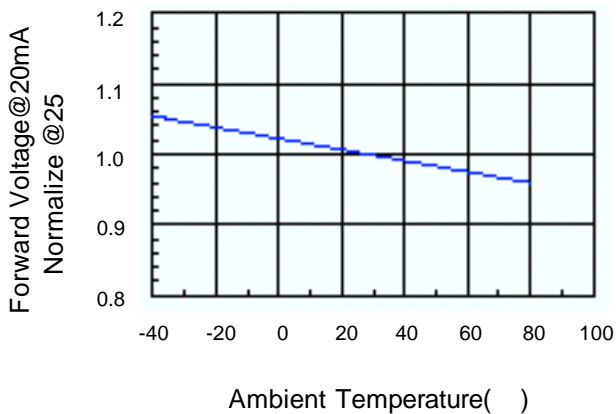

Fig.4 Relative Intensity vs. Temperature

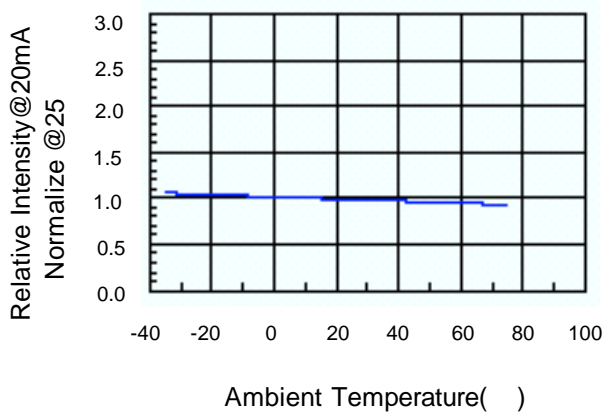

Fig.5 Relative Intensity vs. Wavelength

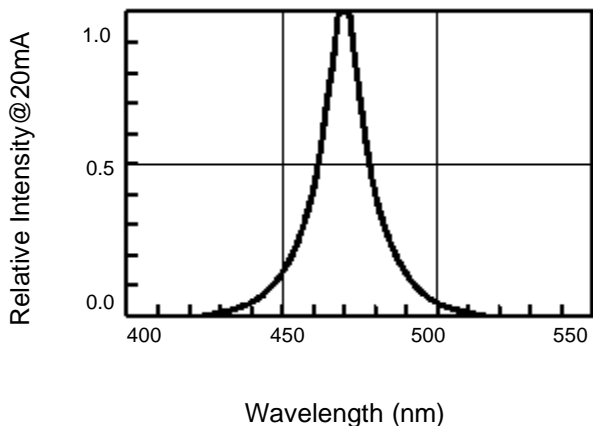
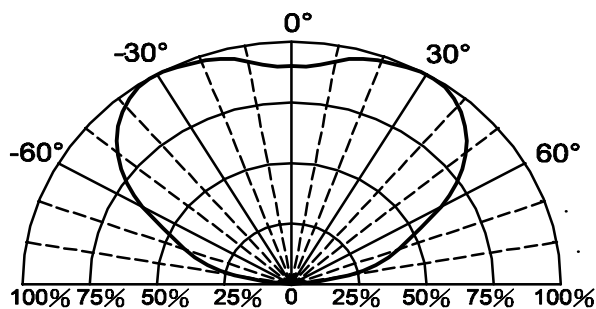
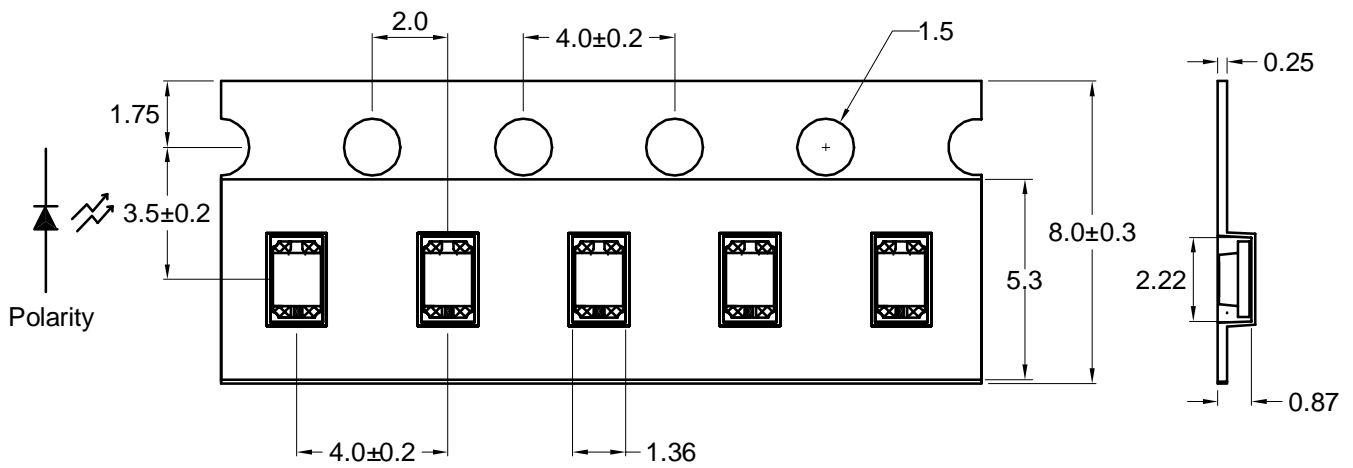

Fig.6 Directive Radiation





Carrier Type Dimensions



Note : The tolerances unless mentioned is ±0.1mm, Angle ± 0.5. Unit=mm.

Packing Specifications

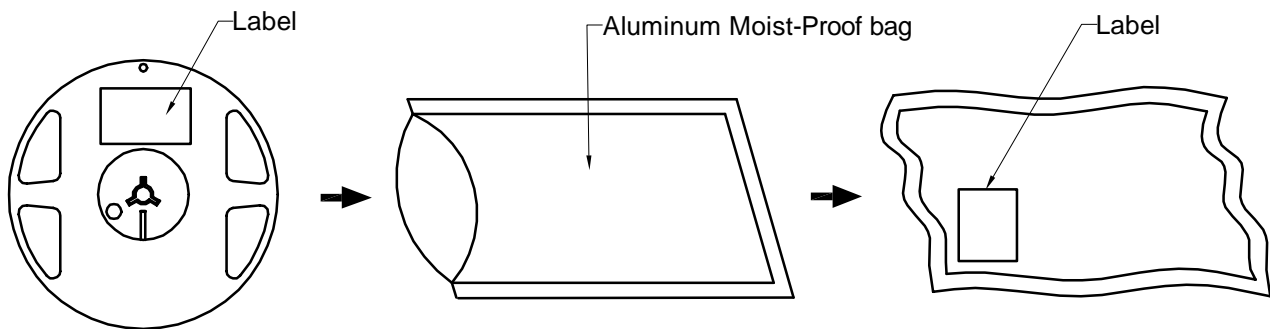

Part No.	Description	Quantity/Reel
LG-170RGB-CT	8.0mm tape, 7" reel	4000 devices



Label Explanation

 立碁電子工業股份有限公司 LIGITEK ELECTRONICS CO., LTD.	
PART NO. : LG-170RGB-CT	
LOT NO. : 93000454	
Q'TY(PCS) : 4000 PCS	
BIN/HUE : Q/S/Q	

BIN : Luminous Intensity

Reel Dimensions

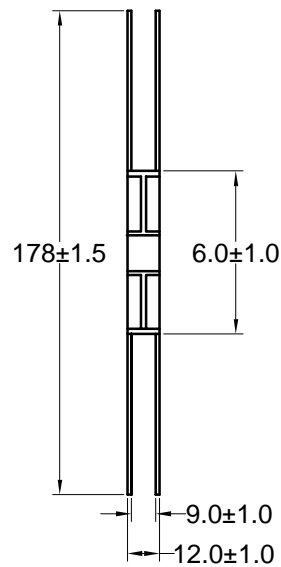
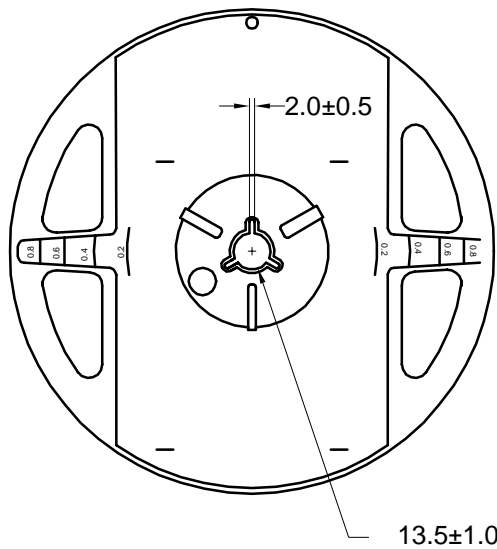



LIGITEK

LIGITEK ELECTRONICS CO.,LTD.
Property of Ligitek Only

PART NO. LG-170RGB-CT

Page 10/13

Box Explanation

1. 5 BAG / INNER BOX
2. INNER BOX SIZE : L X W X H 23cm X 8.5cm x 26cm

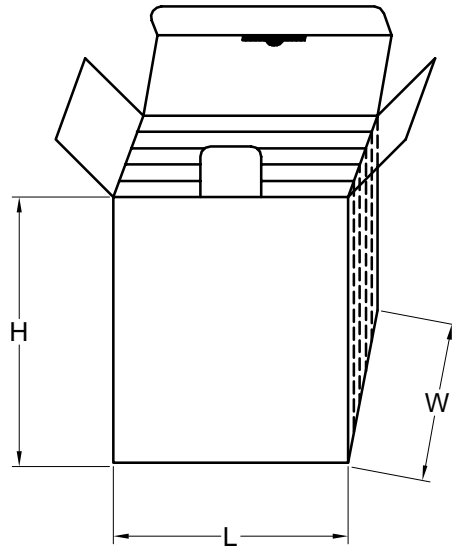

3. 10 INNER BOXES / CARTON
4. CARTON SIZE : L X W X H 49cm X 46cm x 29cm

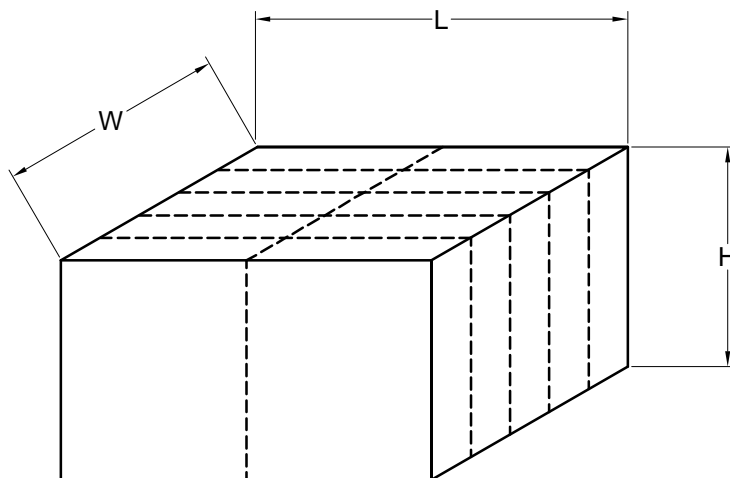



Recommended Soldering Conditions

1. Hand Solder

Basic spec is 280 3 sec one time only.

2. Wave Solder

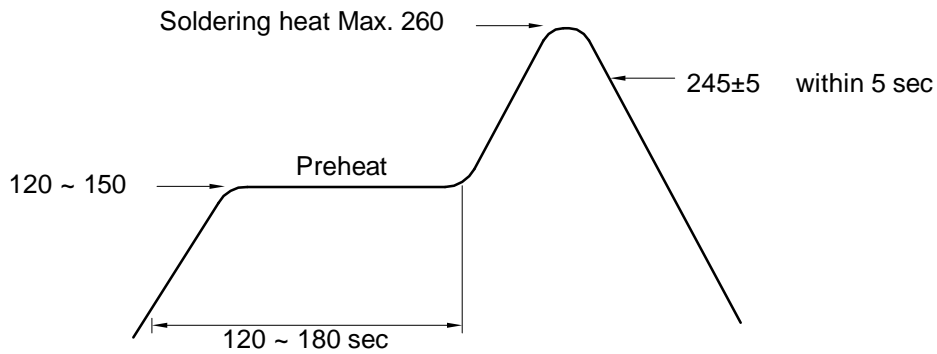

3-1. LEAD Reflow Solder

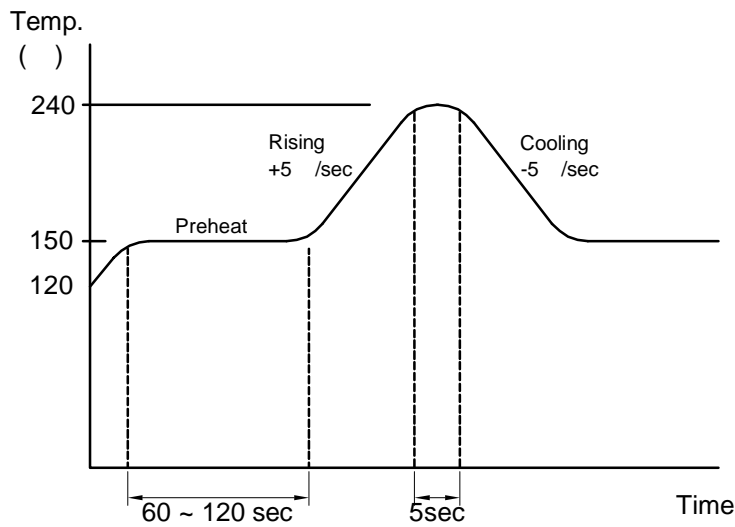

3-2 PB-Free Reflow Solder

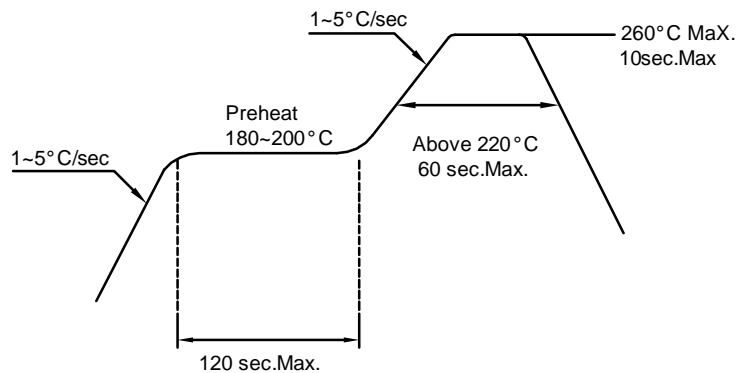

Reflow Soldering should not be done more than two times.



Precautions For Use:

Storage time:

- 1.The operation of Temperatures and RH are : 5 ~35 ,RH60%.
- 2.Once the package is opened, the products should be used within a week.
Otherwise, they should be kept in a damp proof box with descanting agent.
Considering the tape life, we suggest our customers to use our products within a year(from production date).
- 3.If opened more than one week in an atmosphere 5 ~ 35 ,RH60%, they should be treated at 60 ±5 fo r 15hrs.

Drive Method:

LED is a current operated device, and therefore, requirer some kind of current limiting incorporated into the driver circuit. This current limiting typically takes the form of a current limiting resistor placed in series with the LED.

Consider worst case voltage variations than could occur across the current limiting resistor. The forwr d current should not be allowed to change by more than 40 % of its desired value.

Circuit model A

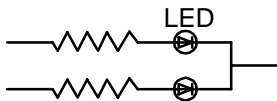

Circuit model B

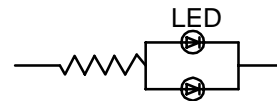

(A) Recommended circuit.

(B) The difference of brightness between LED could be found due to the VF-IF characteristics of LED.

Cleaning:

Use alcohol-based cleaning solvents such as isopropyl alcohol to clean the LED.

ESD(Electrostatic Discharge):

Static Electricity or power surge will damage the LED. Use of a conductive wrist band or anti-electrosatic glove is recommended when handing these LED. All devices, equipment and machinery must be properly grounded.



Reliability Test:

Classification	Test Item	Test Condition	Reference Standard
Endurance Test	Operating Life Test	1.Ta=Under Room Temperature As Per Data Sheet Maximum Rating. 2.If=20mA 3.t=1000 hrs (-24hrs, +72hrs)	MIL-STD-750D: 1026 MIL-STD-883D: 1005 JIS C 7021: B-1
	High Temperature Storage Test	1.Ta=105 ±5 2.t=1000 hrs (-24hrs, +72hrs)	MIL-STD-883D:1008 JIS C 7021: B-10
	Low Temperature Storage Test	1.Ta=-40 ±5 2.t=1000 hrs (-24hrs, +72hrs)	JIS C 7021: B-12
	High Temperature High Humidity Storage Test	1.Ta=65 ±5 2.RH=90 %-95% 3.t=1000hrs ±2hrs	MIL-STD-202F:103B JIS C 7021: B-11
Environmental Test	Thermal Shock Test	1.Ta=105 ±5 & -40 ±5 (10min) (10min) 2.total 10 cycles	MIL-STD-202F: 107D MIL-STD-750D: 1051 MIL-STD-883D: 1011
	Solderability Test	1.T.Sol=235 ±5 2.Immersion time 2 ±0.5sec 3.Coverage 95% of the dipped surface	MIL-STD-202F: 208D MIL-STD-750D: 2026 MIL-STD-883D: 2003 IEC 68 Part 2-20 JIS C 7021: A-2
	Temperature Cycling	1.105 ~ 25 ~ -55 ~ 25 30mins 5mins 30mins 5mins 2.10 Cyeles	MIL-STD-202F: 107D MIL-STD-750D: 1051 MIL-STD-883D: 1010 JIS C 7021: A-4
	IR Reflow	1.T=260°C Max. 10sec.Max. 2. 6 Min	MIL-STD-750D:2031.2 J-STD-020