



Features

- ◇ For IF SAW filter
- ◇ High attenuation
- ◇ Single-ended operation
- ◇ Dual In-line Package
- ◇ RoHS compliant (2002/95/EC), Pb-free

Specifications

Parameter	Unit	Minimum	Typical	Maximum
Center Frequency	MHz	159.65	160	160.35
Insertion Loss	dB	-	25.7	26
3dB Bandwidth	MHz	40.7	40.79	-
30 dB Bandwidth	MHz	-	42.27	-
40 dB Bandwidth	MHz	-	42.52	42.8
Passband Variation	dB	-	0.7	1.2
Absolute Delay	usec	-	1.75	-
Ultimate Rejection	dB	50	52	-
Material Temperature coefficient	KHz/°C	-13.12		
Substrate Material	-	128LN		
Ambient Temperature	°C	25		
Operating Temperature Range	°C	-40	-	+85
Storage Temperature Range	°C	-45	-	+105
DC Voltage	V	0		
Input Power	dBm	-	-	10
ESD Class	-	1A		
Package Size	DIP2712 (27.0x12.8x4.7mm3)			

Notes:

1. All specifications are based on the test circuit shown;
2. In production, all specifications are measured by Agilent Network analyzer and full 2 port calibration at room temperature;
3. Electrical margin has been built into the design to account for the variations due to temperature drift and manufacturing tolerances;
4. This is the optimum impedance in order to achieve the performance show.

	SIPAT Co., Ltd. (CETC No.26 Research Institute) #14 Nanping Huayuan Road, Chongqing, China, 400060	Part Number	LBN16052	
		Rev. Date	2008-07-03	
		Ver.	1.0	Page

Matching Configuration



L1=L2=27nH

Source/Load Impedance=50 ohm

Notes - Component values may change depending on board layout.

Package Dimension

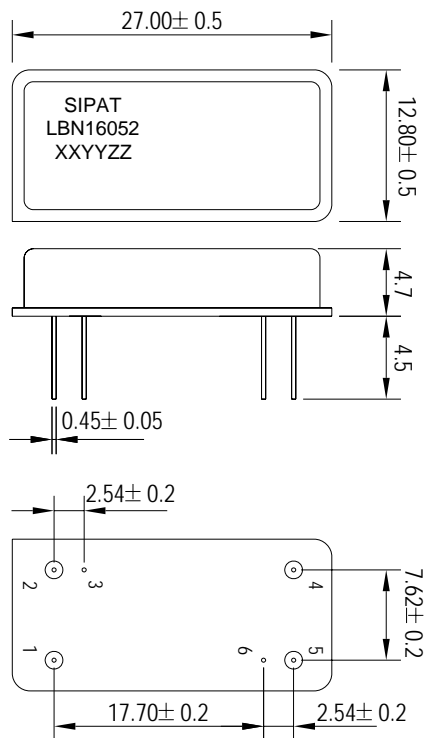

Pad Configuration:

Input 1
Output 5
Ground All Others

Marking Configuration:

- 1) SIPAT: Manufacturer Name
- 2) LBN16052: Part Number
- 3) XXYY: Date(Year/month)
- 4) ZZ: Identified Code

Package: DIP2712

Unit: mm



SIPAT Co., Ltd.
(CETC No.26 Research Institute)
#14 Nanping Huayuan Road,
Chongqing, China, 400060

Part Number	LBN16052	
Rev. Date	2008-07-03	
Ver.	1.0	Page 2/3



Typical Performance

Frequency Respond

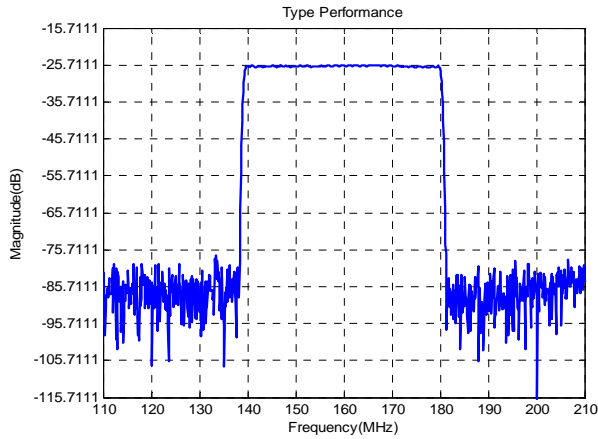

Horizontal: 10MHz/Div Vertical: 10dB/Div

Passband Respond

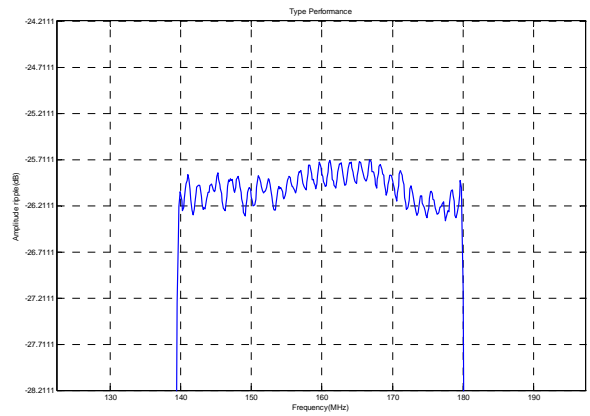

Horizontal: 10MHz/Div Vertical: 0.5dB/Div

Group Delay Variation(f0±20MHz)

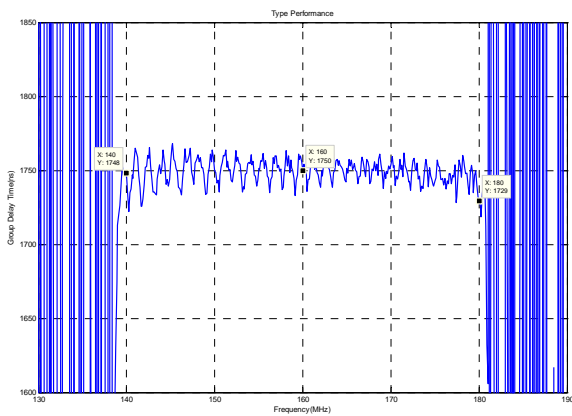

Horizontal: 10MHz/Div Vertical: 50ns/Div

Phase Linearity(f0±20MHz)

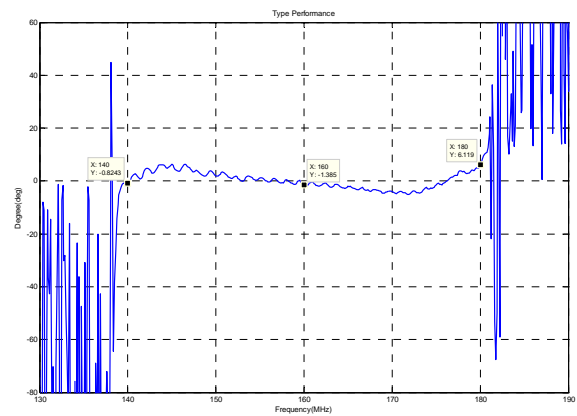

Horizontal: 10MHz/Div Vertical: 20deg/Div

Smith Chart S11

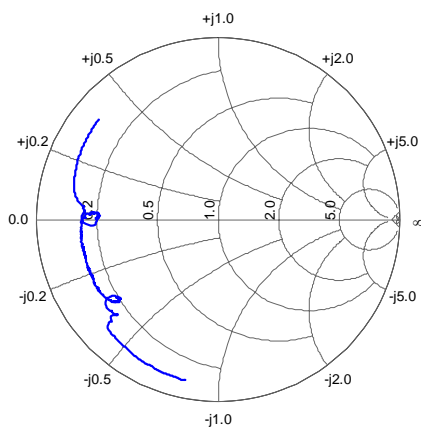

Smith Chart S22

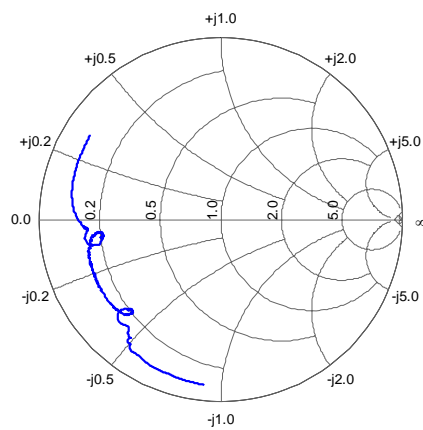

SIPAT Co., Ltd.
(CETC No.26 Research Institute)
#14 Nanping Huayuan Road,
Chongqing, China, 400060

Part Number	LBN16052	
Rev. Date	2008-07-03	
Ver.	1.0	Page 3/3