

3-TERMINAL 1A POSITIVE ADJUSTABLE REGULATOR

The KIA317F/FP/PI/S is adjustable 3-terminal positive voltage regulator capable of supplying in excess of 1.5A over a 1.25V to 37V output range. This is exceptionally easy to use and require only two external resistors to set the output voltage. Further, both line and load regulation are better than standard fixed regulators.

FEATURES

- Adjustable output between 1.25V and 37V
- Guaranteed 1.5A output current
- Line regulation typically 0.001%/V
- Load regulation typically 0.1%
- 80dB ripple rejection (with Cadj)
- Internal thermal overload protection
- Internal short-circuit current limiting
- Output transistor safe-area compensation

MAXIMUM RATINGS (Ta=25 °C)

| CHARACTERISTIC | | SYMBOL | RATING | UNIT |
|------------------------------------|----------|------------|---------|------|
| Input-Output Voltage Differential | | V_{IN} | 40 | V |
| Output Current | | I_{OUT} | 1.5 | A |
| Power Dissipation (No Heatsink) | F | P_D | 1.3 | W |
| | FP | | 2.0 | |
| | PI | | 2.0 | |
| | S (Note) | | 1.0 | |
| Operating Temperature | | T_{opr} | -30 85 | |
| Storage Temperature | | T_{stg} | -65 150 | |
| Lead Temperature | | T_{lead} | 230 | |

Note) : Package Mounted on FR-4 PCB 36 × 18 × 1.5mm.
mounting pad for the GND Lead min. 6cm².

BLOCK DIAGRAM

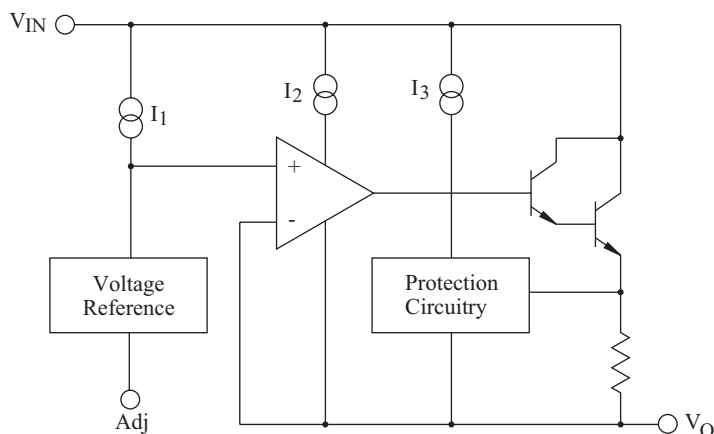

KIA317F/FP/PI/S

ELECTRICAL CHARACTERISTICS (Ta=25 °C)

(Vin-Vo=5V, Io=0.5A, 0 ≤ Tj ≤ 125 °C, I_MAX=1.5A, unless otherwise specified.)

| CHARACTERISTIC | SYMBOL | TEST CONDITION | MIN. | TYP. | MAX. | UNIT |
|---|----------|---|------|--------|------|-------|
| Line Regulation | Vo(Line) | Ta=25 °C, Io=10mA | - | 0.01 | 0.04 | % / V |
| | | Ta=0 ~ 125 °C, Io=10mA | - | 0.02 | 0.07 | |
| Load Regulation | Vo(Load) | Ta=25 °C | - | 0.1 | 0.5 | % |
| | | Ta=0 ~ 125 °C | - | 0.3 | 1.5 | |
| Adjustable Pin Current | IAdj | | - | 50 | 100 | μA |
| Adjustable Pin Current Change | IAdj | 10mA Io I_MAX, 3V Vin-Vout 40V | - | 0.2 | 5 | μA |
| Reference Voltage | Vref | 10mA Io I_MAX, 3V Vin-Vout 40V, P P_MAX | 1.20 | 1.25 | 1.30 | V |
| Temperature Stability | ST_T | T_Min Tj T_MAX | - | 1 | - | % |
| Minimum Load Current to Maintain Regulation | Io(MIN) | (Vin-Vout)=40V | - | 3.5 | 10 | mA |
| Current Limit | Io(MAX) | (Vin-Vout) 15V, P P_MAX | 1.5 | 2.2 | 3.4 | A |
| | | (Vin-Vout) 40V, P P_MAX, Ta=25 °C | 0.15 | 0.4 | - | A |
| Output Noise Voltage | VNO | Ta=25 °C, 10Hz ≤ f ≤ 10kHz, % of Vout | - | 0.0003 | - | % |
| Ripple Rejection Ratio | RR | Vo=10V, f=120Hz | - | 65 | - | dB |
| | | CAdj=10μF | 66 | 80 | - | |
| Long Term Stability | ST | Ta=25 °C for end point measurement, 1000 Hr | - | 0.3 | 1 | % |

Note : Load and line regulation are specified at constant junction temperature.

Change in Vo due to heating effects must be taken into account separately. Pulse testing with low duty is used.

TYPICAL APPLICATION (PROGRAMMABLE REGULATOR)

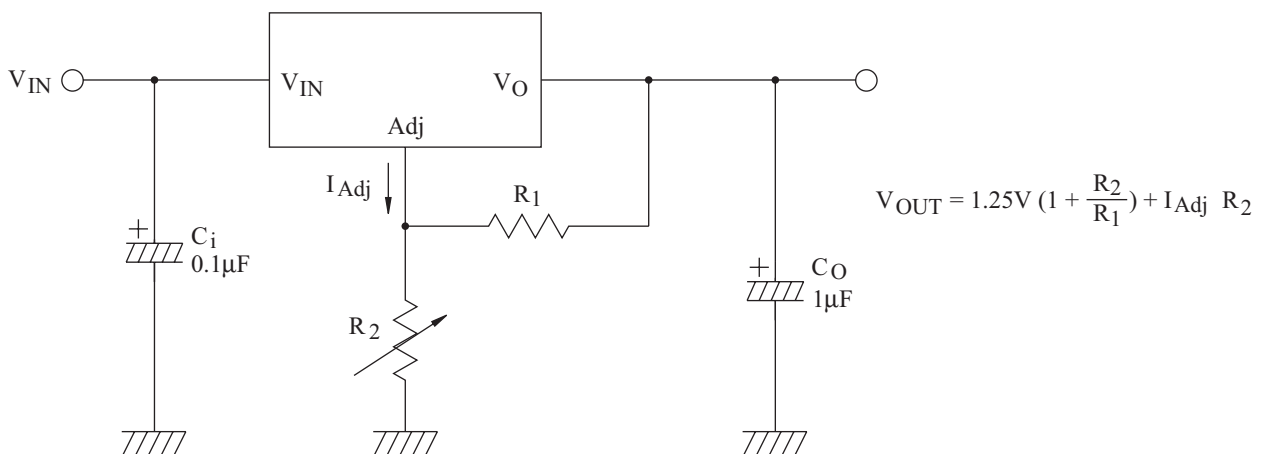

Ci is required when regulator is located an appreciable distance from power supply filter.

Co is not needed for stability, however, in the range of 1μF to 100μF of aluminum or tantalum electrolytic are commonly used to provide improved output impedance and rejection of transients.

Since IAdj is controlled to less than 100μA, the error associated with this term is negligible in most applications.

KIA317F/FP/PI/S

Load Regulation

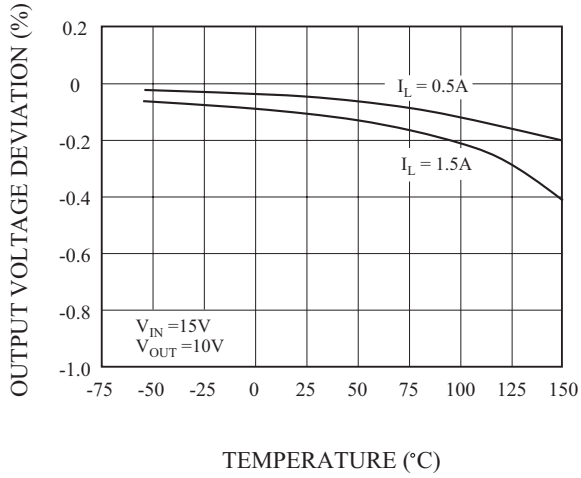

Current Limit

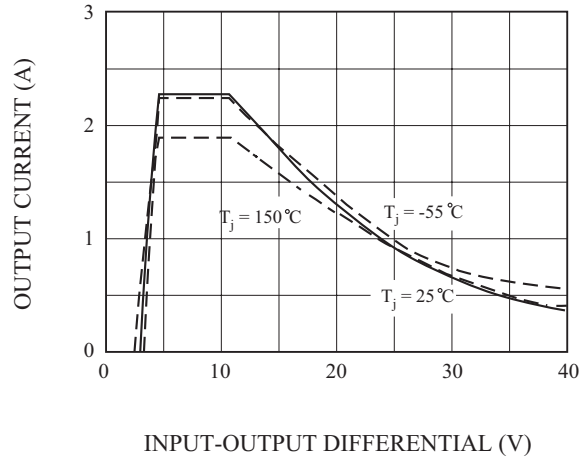

Adjustment Current

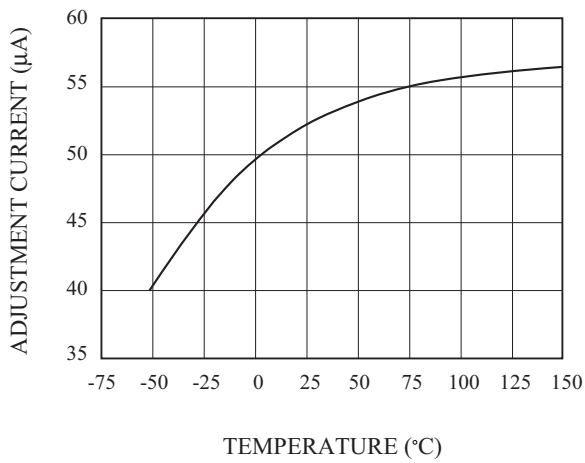

Dropout Voltage

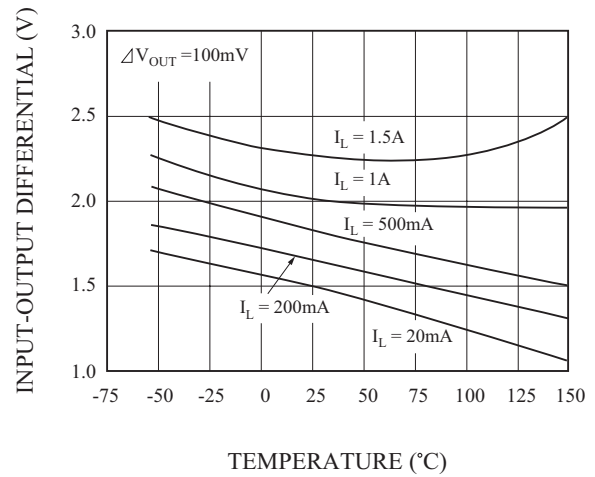

Temperature Stability

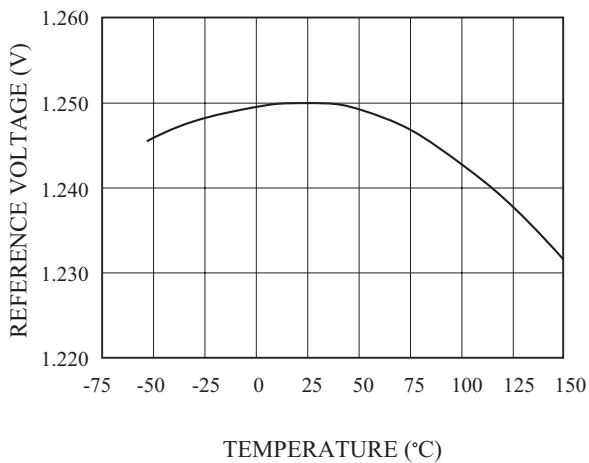

Minimum Operating Current

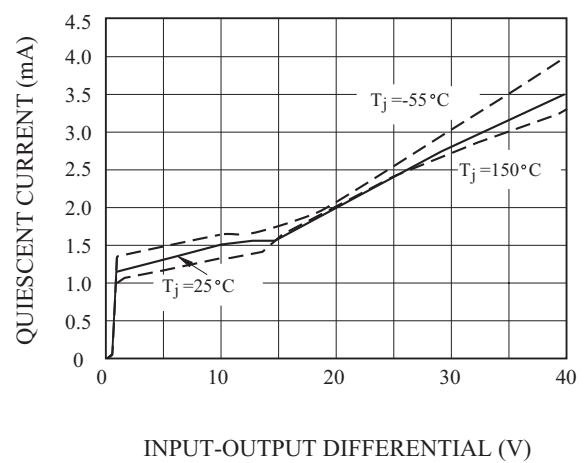

Ripple Rejection

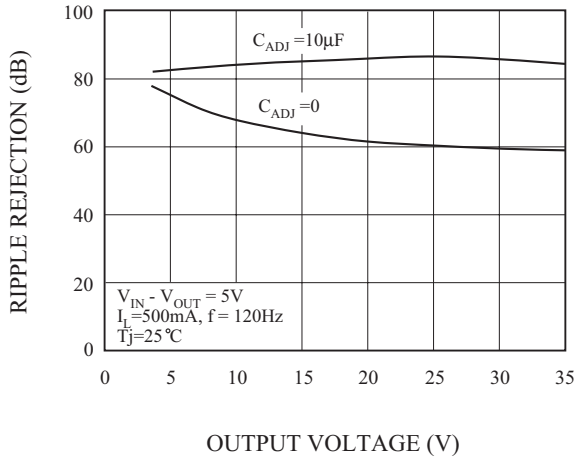

Ripple Rejection

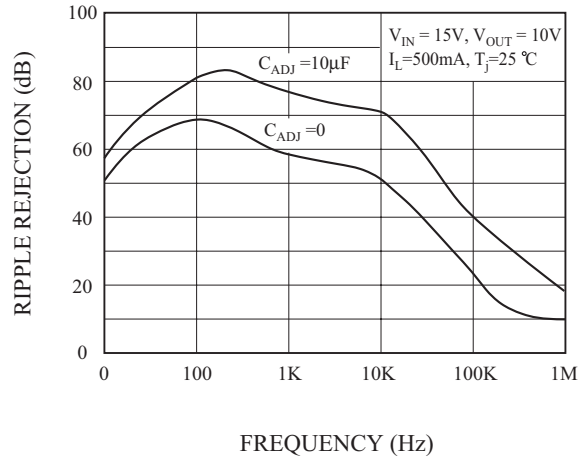

Ripple Rejection

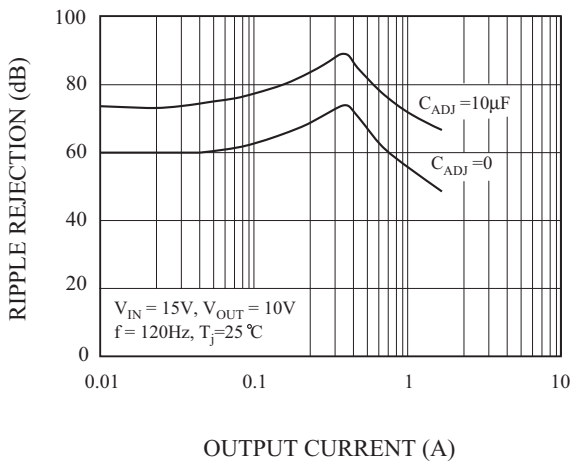

Output Impedance

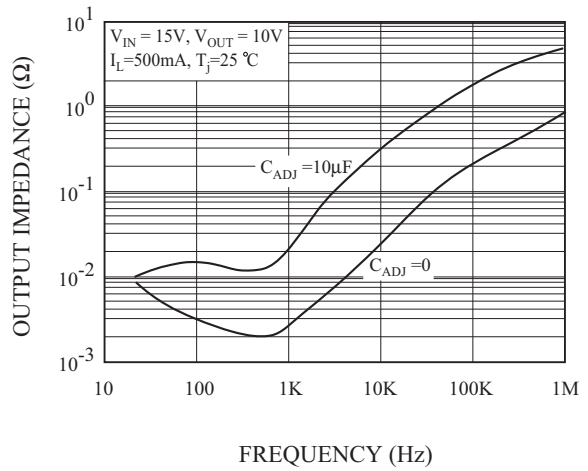

Line Transient Response

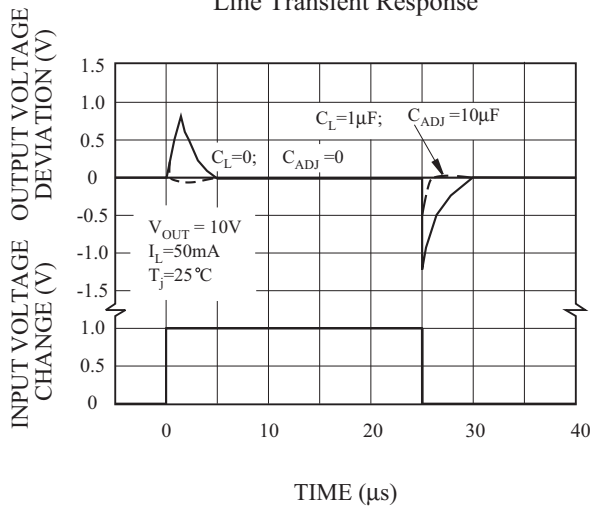

Line Transient Response

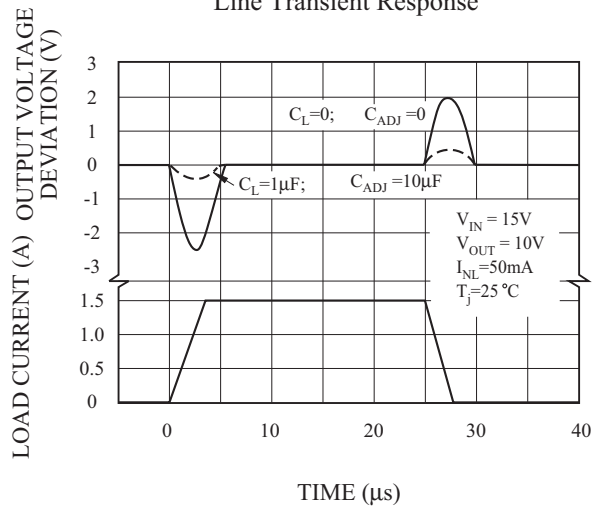

KIA317F/FP/PI/S

Power Dissipation-2 (DPAK)

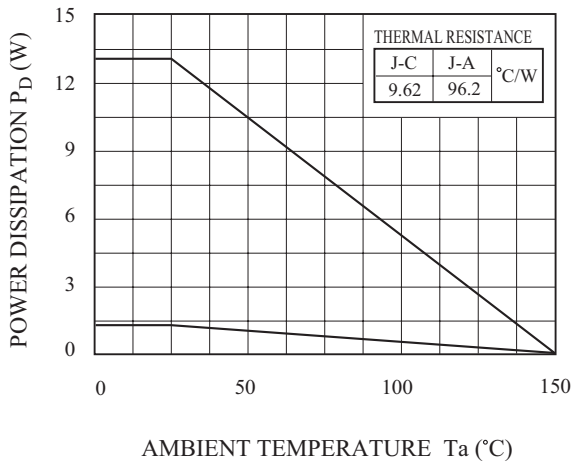

Power Dissipation-3 (D²PAK)

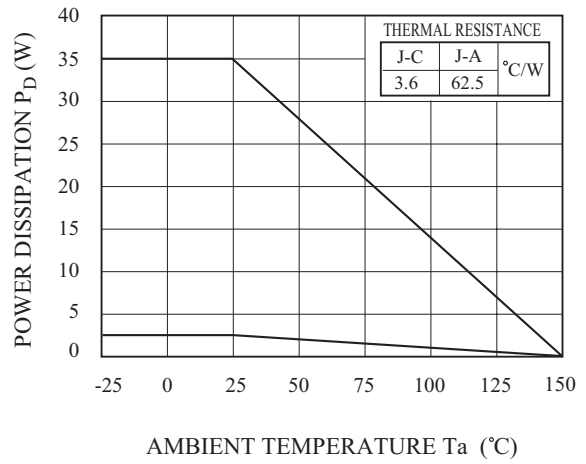

Power Dissipation-1 (TO-220IS)

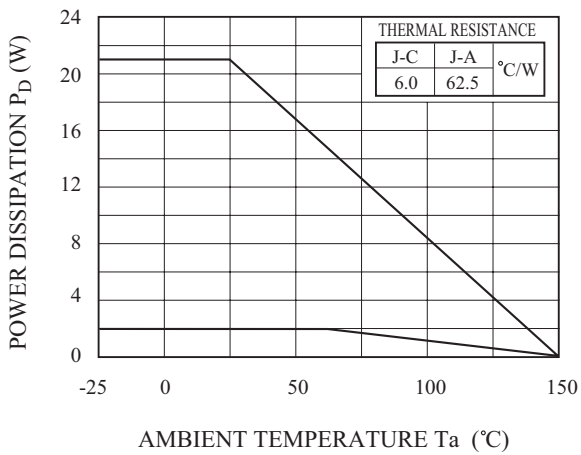

Power Dissipation-4 (SOT-223)

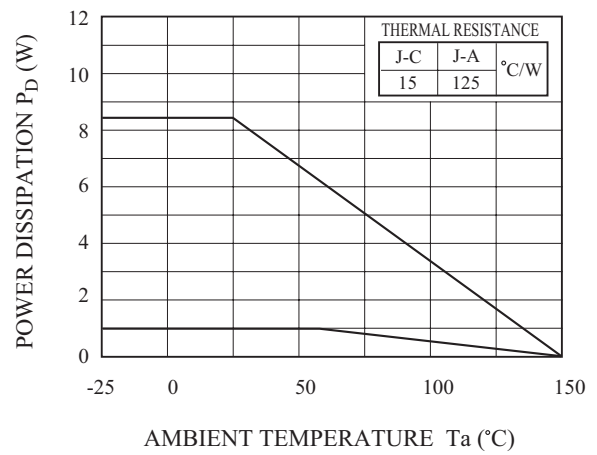

KIA317F/FP/PI/S

