

BCR8PM

MEDIUM POWER USE

INSULATED TYPE, PLANAR PASSIVATION TYPE

Refer to the page 6 as to the product guaranteed maximum junction temperature 150°C

BCR8PM

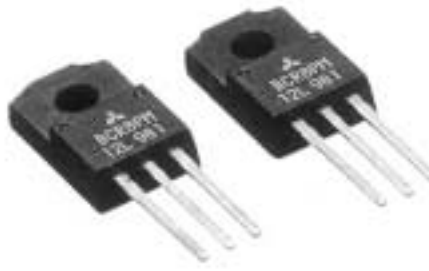

- **IT (RMS)** **8A**
- **VDRM** **600V**
- **IFGT I, IRGT I, IRGT III** **20mA**
- **Viso** **2000V**
- **UL Recognized: Yellow Card No.E80276(N)**

File No. E80271

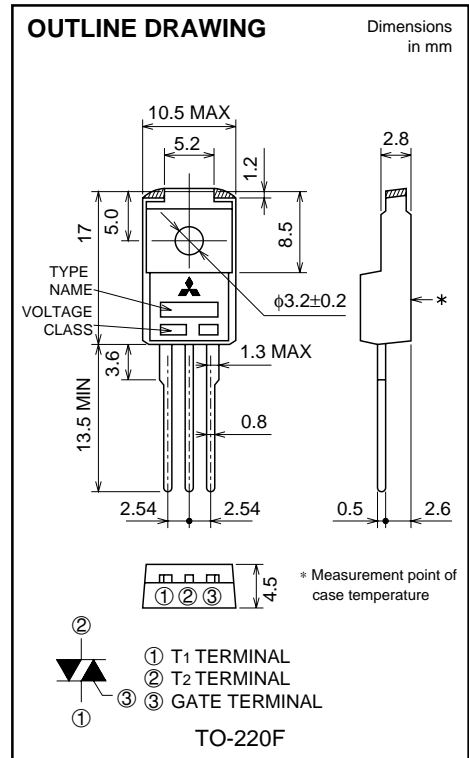

APPLICATION

Switching mode power supply, light dimmer, electric flasher unit, control of household equipment such as TV sets · stereo · refrigerator · washing machine · infrared kotatsu · carpet, solenoid drivers, small motor control, copying machine, electric tool, other general purpose control applications

MAXIMUM RATINGS

Symbol	Parameter	Voltage class	
		12	Unit
VDRM	Repetitive peak off-state voltage *1	600	V
VDSM	Non-repetitive peak off-state voltage *1	720	V

Symbol	Parameter	Conditions	Ratings	Unit
IT (RMS)	RMS on-state current	Commercial frequency, sine full wave 360° conduction, T _c =88°C	8	A
ITSM	Surge on-state current	60Hz sinewave 1 full cycle, peak value, non-repetitive	80	A
I ² _t	I ² _t for fusing	Value corresponding to 1 cycle of half wave 60Hz, surge on-state current	26	A ² s
PGM	Peak gate power dissipation		5	W
PG (AV)	Average gate power dissipation		0.5	W
VGM	Peak gate voltage		10	V
IGM	Peak gate current		2	A
T _j	Junction temperature		-40 ~ +125	°C
T _{stg}	Storage temperature		-40 ~ +125	°C
—	Weight	Typical value	2.0	g
Viso	Isolation voltage	T _a =25°C, AC 1 minute, T ₁ · T ₂ · G terminal to case	2000	V

*1. Gate open.

BCR8PM

Refer to the page 6 as to the product guaranteed maximum junction temperature 150°C

MEDIUM POWER USE
INSULATED TYPE, PLANAR PASSIVATION TYPE

ELECTRICAL CHARACTERISTICS

Symbol	Parameter	Test conditions	Limits			Unit	
			Min.	Typ.	Max.		
IDRM	Repetitive peak off-state current	T _j =125°C, V _{DRM} applied	—	—	2.0	mA	
V _{TM}	On-state voltage	T _c =25°C, I _{TM} =12A, Instantaneous measurement	—	—	1.5	V	
V _{FGT I}	Gate trigger voltage *2	T _j =25°C, V _D =6V, R _L =6Ω, R _G =330Ω	I	—	—	1.5	V
V _{RGT I}			II	—	—	1.5	V
V _{RGT III}			III	—	—	1.5	V
I _{FGT I}	Gate trigger current *2	T _j =25°C, V _D =6V, R _L =6Ω, R _G =330Ω	I	—	—	20	mA
I _{RGT I}			II	—	—	20	mA
I _{RGT III}			III	—	—	20	mA
V _{GD}	Gate non-trigger voltage	T _j =125°C, V _D =1/2V _{DRM}	0.2	—	—	V	
R _{th (j-c)}	Thermal resistance	Junction to case *3	—	—	3.7	°C/W	
(dv/dt) _c	Critical-rate of rise of off-state commutating voltage *4	T _j =125°C	10	—	—	V/μs	

*2. Measurement using the gate trigger characteristics measurement circuit.

*3. The contact thermal resistance R_{th (c-f)} in case of greasing is 0.5°C/W.

*4. Test conditions of the critical-rate of rise of off-state commutating voltage is shown in the table below.

Test conditions	Commutating voltage and current waveforms (inductive load)
1. Junction temperature T _j =125°C 2. Rate of decay of on-state commutating current (di/dt) _c =-4.0A/ms 3. Peak off-state voltage V _D =400V	

PERFORMANCE CURVES

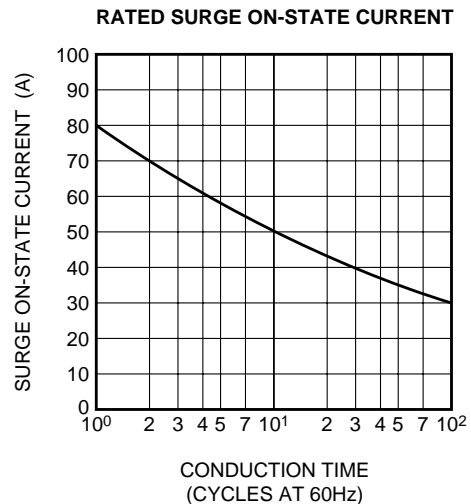
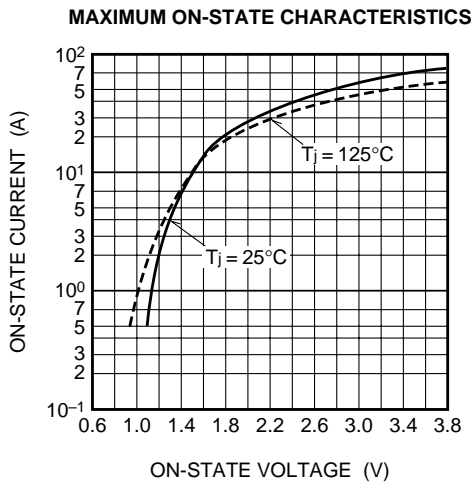

BCR8PM

Refer to the page 6 as to the product guaranteed maximum junction temperature 150°C

MEDIUM POWER USE
INSULATED TYPE, PLANAR PASSIVATION TYPE

GATE CHARACTERISTICS (I, II AND III)

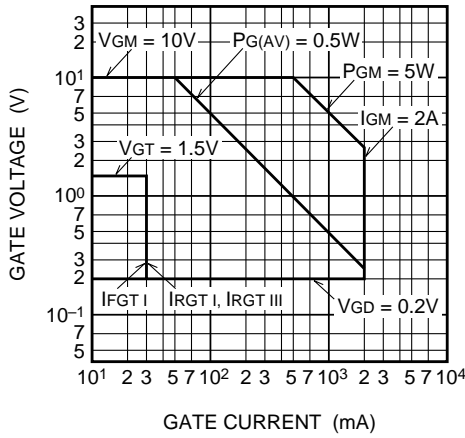

GATE TRIGGER CURRENT VS. JUNCTION TEMPERATURE

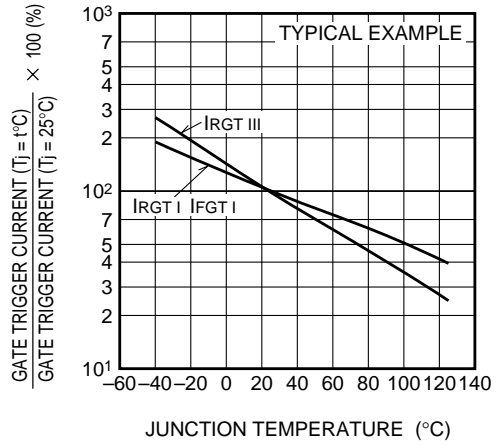

GATE TRIGGER VOLTAGE VS. JUNCTION TEMPERATURE

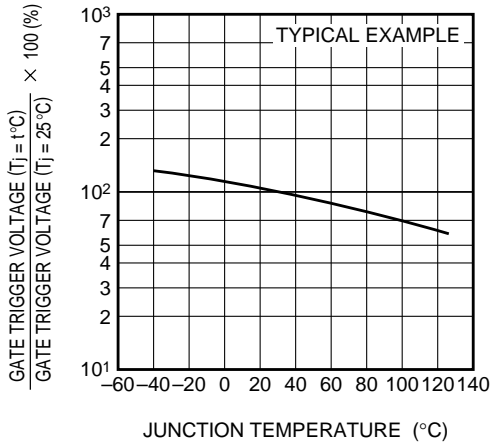

MAXIMUM TRANSIENT THERMAL IMPEDANCE CHARACTERISTICS (JUNCTION TO CASE)

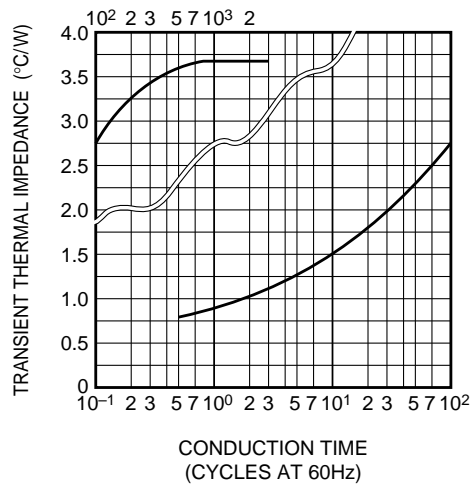

MAXIMUM TRANSIENT THERMAL IMPEDANCE CHARACTERISTICS (JUNCTION TO AMBIENT)

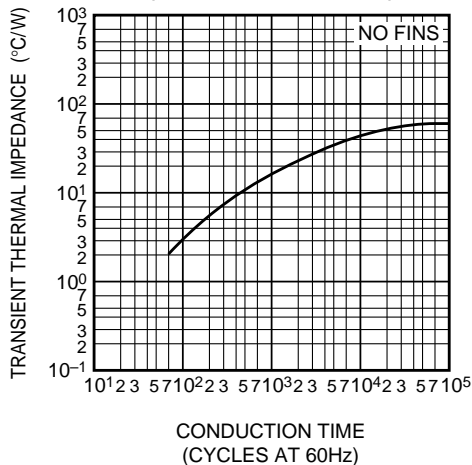

MAXIMUM ON-STATE POWER DISSIPATION

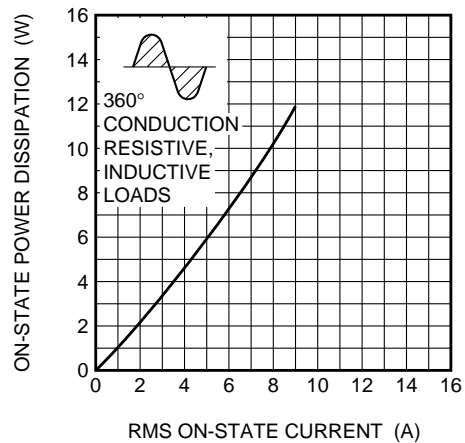

BCR8PM

Refer to the page 6 as to the product guaranteed maximum junction temperature 150°C

MEDIUM POWER USE
INSULATED TYPE, PLANAR PASSIVATION TYPE

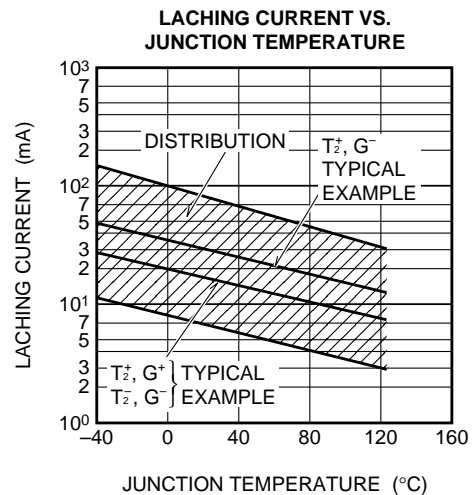
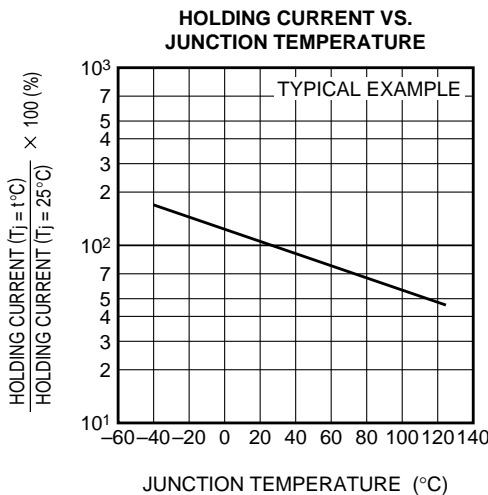
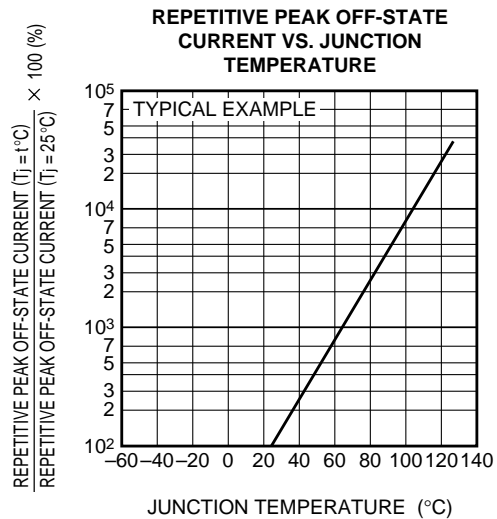
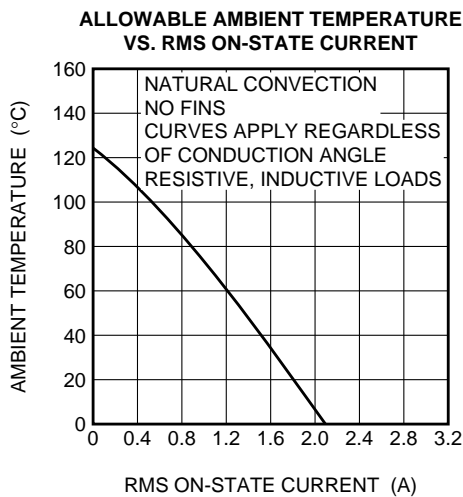
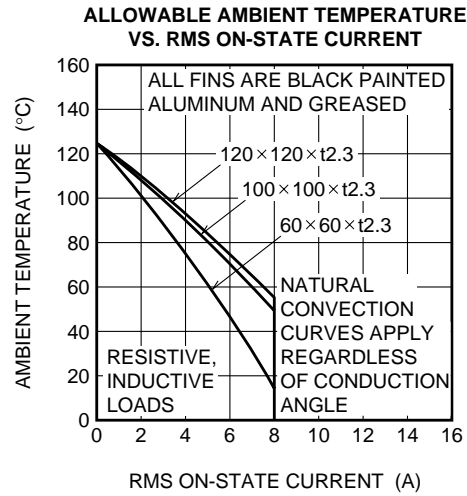
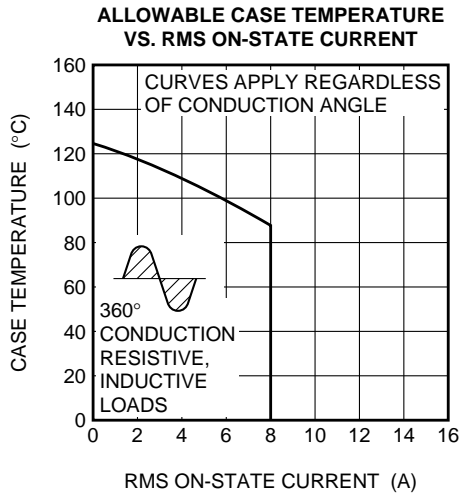

BCR8PM

Refer to the page 6 as to the product guaranteed maximum junction temperature 150°C

MEDIUM POWER USE
INSULATED TYPE, PLANAR PASSIVATION TYPE

BREAKOVER VOLTAGE VS. JUNCTION TEMPERATURE

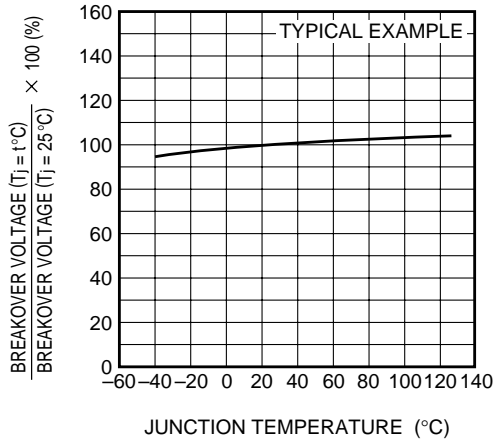

BREAKOVER VOLTAGE VS. RATE OF RISE OF OFF-STATE VOLTAGE

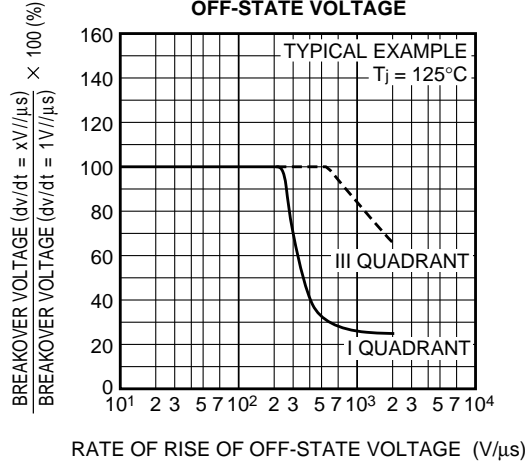

COMMUTATION CHARACTERISTICS

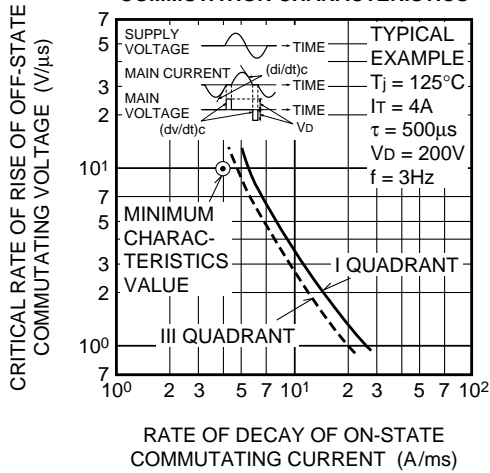

GATE TRIGGER CURRENT VS. GATE CURRENT PULSE WIDTH

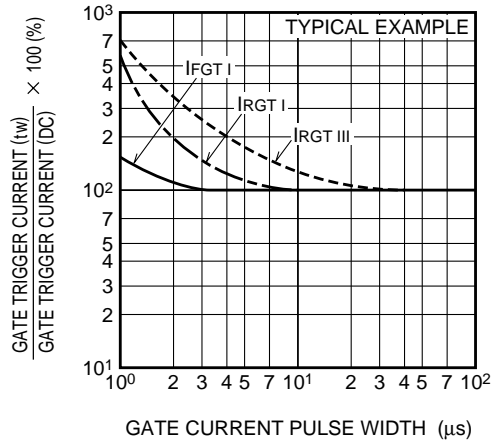

GATE TRIGGER CHARACTERISTICS TEST CIRCUITS

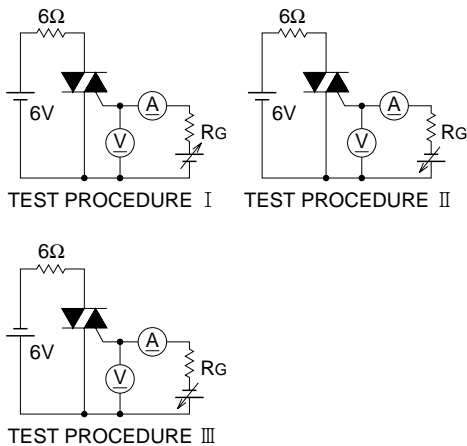

BCR8PM

MEDIUM POWER USE

INSULATED TYPE, PLANAR PASSIVATION TYPE

The product guaranteed maximum junction temperature 150°C (See warning.)

BCR8PM

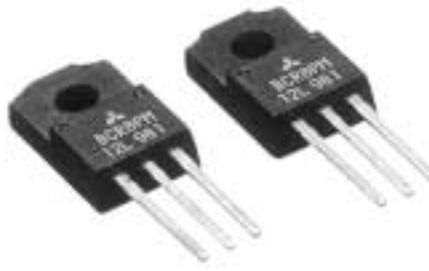

- **IT (RMS)** **8A**
- **VDRM** **600V**
- **IFGT I, IRGT I, IRGT III** **20mA**
- **Viso** **2000V**
- **UL Recognized: Yellow Card No.E80276(N)**

File No. E80271

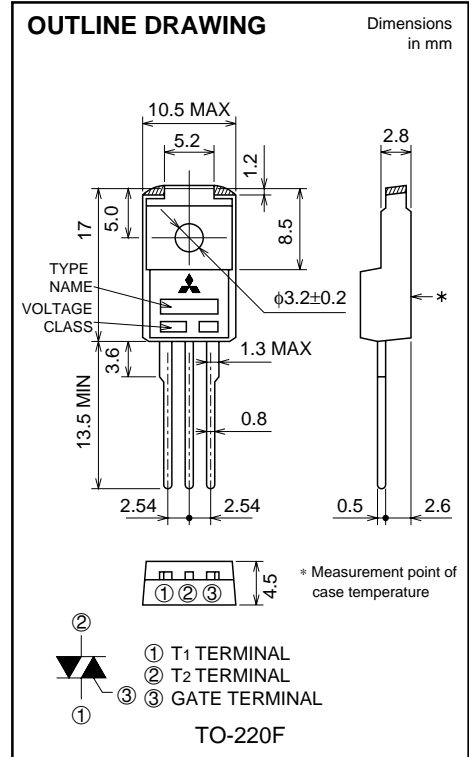

APPLICATION

Switching mode power supply, light dimmer, electric flasher unit, control of household equipment such as TV sets · stereo · refrigerator · washing machine · infrared kotatsu · carpet, solenoid drivers, small motor control, copying machine, electric tool, other general purpose control applications

(Warning)

1. Refer to the recommended circuit values around the triac before using.
2. Be sure to exchange the specification before using. If not exchanged, general triacs will be supplied.

MAXIMUM RATINGS

Symbol	Parameter	Voltage class		Unit
		12		
VDRM	Repetitive peak off-state voltage *1	600		V
VDSM	Non-repetitive peak off-state voltage *1	720		V

Symbol	Parameter	Conditions	Ratings	Unit
IT (RMS)	RMS on-state current	Commercial frequency, sine full wave 360° conduction, Tc=113°C	8	A
ITSM	Surge on-state current	60Hz sinewave 1 full cycle, peak value, non-repetitive	80	A
I ² _t	I ² _t for fusing	Value corresponding to 1 cycle of half wave 60Hz, surge on-state current	26	A ² s
PGM	Peak gate power dissipation		5	W
PG (AV)	Average gate power dissipation		0.5	W
VGM	Peak gate voltage		10	V
IGM	Peak gate current		2	A
T _j	Junction temperature		-40 ~ +150	°C
T _{stg}	Storage temperature		-40 ~ +150	°C
—	Weight	Typical value	2.0	g
Viso	Isolation voltage	Ta=25°C, AC 1 minute, T1 · T2 · G terminal to case	2000	V

*1. Gate open.

BCR8PM

The product guaranteed maximum junction temperature 150°C (See warning.)

MEDIUM POWER USE
INSULATED TYPE, PLANAR PASSIVATION TYPE

ELECTRICAL CHARACTERISTICS

Symbol	Parameter	Test conditions	Limits			Unit	
			Min.	Typ.	Max.		
IDRM	Repetitive peak off-state current	T _j =150°C, V _{DRM} applied	—	—	2.0	mA	
V _{TM}	On-state voltage	T _c =25°C, I _{TM} =12A, Instantaneous measurement	—	—	1.5	V	
V _{FGT I}	Gate trigger voltage *2	T _j =25°C, V _D =6V, R _L =6Ω, R _G =330Ω	I	—	—	1.5	V
V _{RGT I}			II	—	—	1.5	V
V _{RGT III}			III	—	—	1.5	V
I _{FGT I}	Gate trigger current *2	T _j =25°C, V _D =6V, R _L =6Ω, R _G =330Ω	I	—	—	20	mA
I _{RGT I}			II	—	—	20	mA
I _{RGT III}			III	—	—	20	mA
V _{GD}	Gate non-trigger voltage	T _j =125°C/150°C, V _D =1/2V _{DRM}	0.2/0.1	—	—	V	
R _{th (j-c)}	Thermal resistance	Junction to case *3	—	—	3.7	°C/W	
(dv/dt) _c	Critical-rate of rise of off-state commutating voltage *4	T _j =125°C/150°C	10/1	—	—	V/μs	

*2. Measurement using the gate trigger characteristics measurement circuit.

*3. The contact thermal resistance R_{th (c-f)} in case of greasing is 0.5°C/W.

*4. Test conditions of the critical-rate of rise of off-state commutating voltage is shown in the table below.

Test conditions	Commutating voltage and current waveforms (inductive load)
1. Junction temperature T _j =125°C/150°C 2. Rate of decay of on-state commutating current (di/dt) _c =-4.0A/ms 3. Peak off-state voltage V _D =400V	

PERFORMANCE CURVES

MAXIMUM ON-STATE CHARACTERISTICS

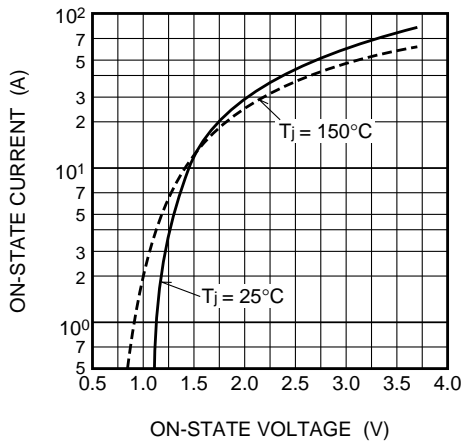

RATED SURGE ON-STATE CURRENT

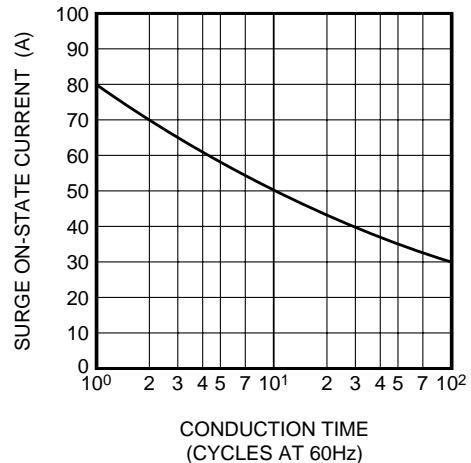

BCR8PM

The product guaranteed maximum junction temperature 150°C (See warning.)

MEDIUM POWER USE
INSULATED TYPE, PLANAR PASSIVATION TYPE

**GATE CHARACTERISTICS
(I, II AND III)**

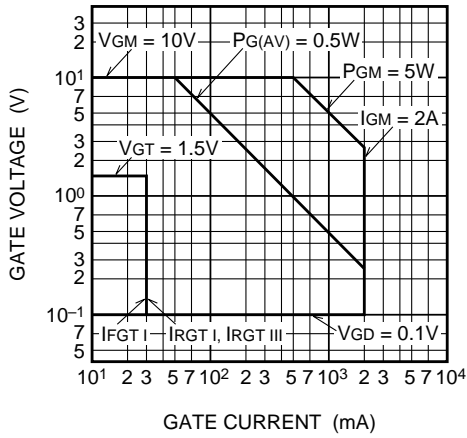

**GATE TRIGGER CURRENT VS.
JUNCTION TEMPERATURE**

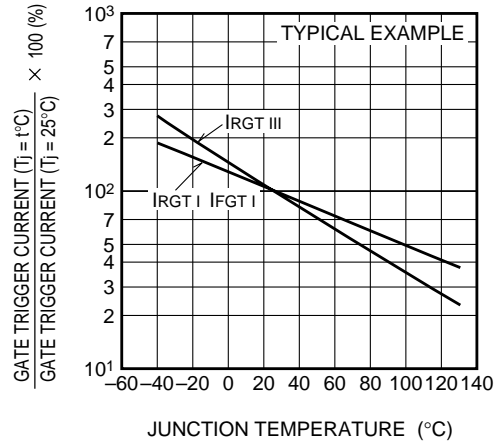

**GATE TRIGGER VOLTAGE VS.
JUNCTION TEMPERATURE**

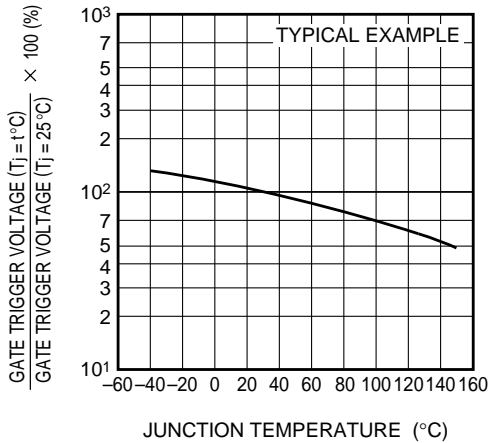

**MAXIMUM TRANSIENT THERMAL
IMPEDANCE CHARACTERISTICS
(JUNCTION TO CASE)**

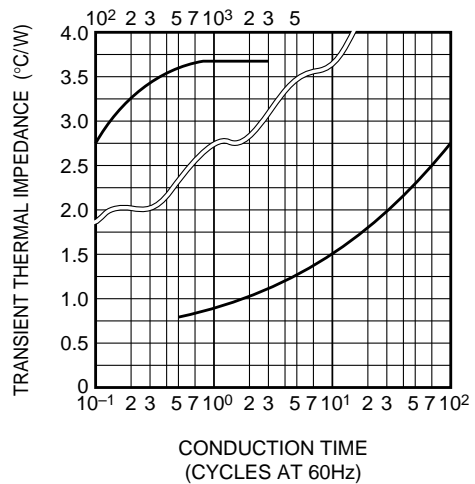

**MAXIMUM TRANSIENT THERMAL
IMPEDANCE CHARACTERISTICS
(JUNCTION TO AMBIENT)**

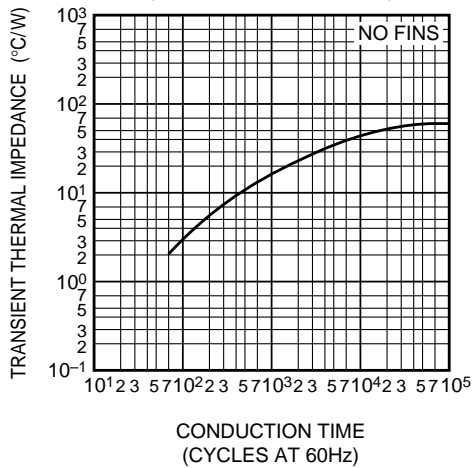

**MAXIMUM ON-STATE POWER
DISSIPATION**

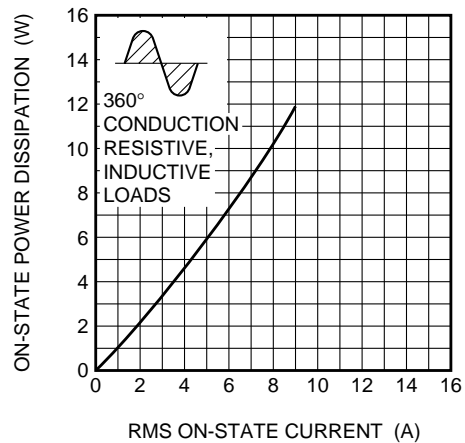

BCR8PM

The product guaranteed maximum junction temperature 150°C (See warning.)

MEDIUM POWER USE
INSULATED TYPE, PLANAR PASSIVATION TYPE

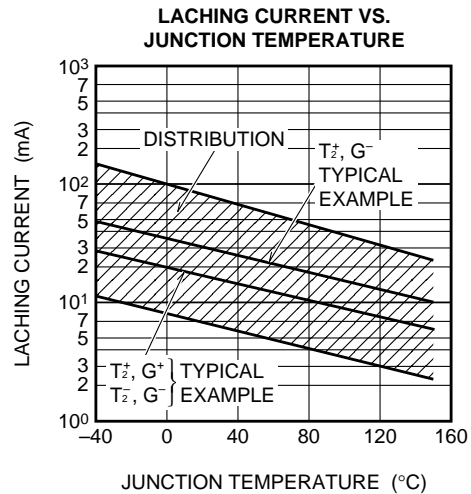
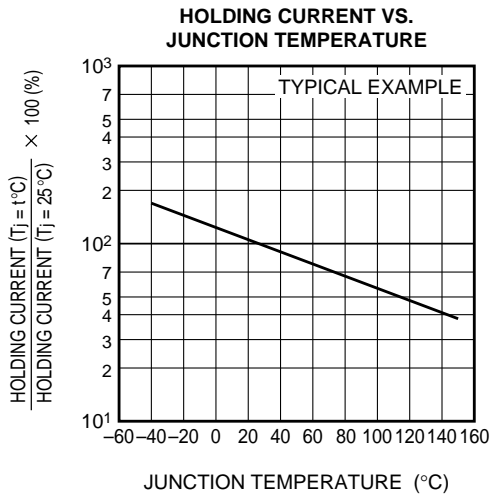
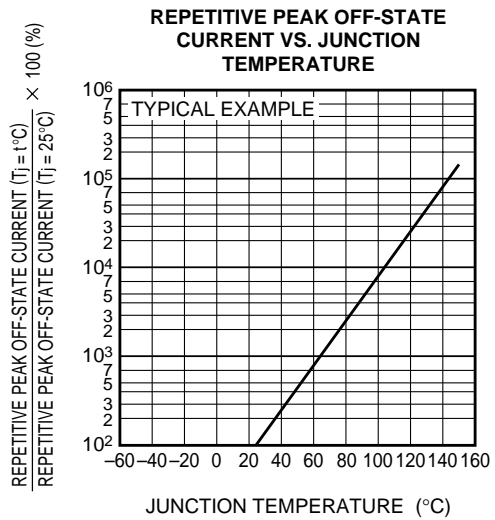
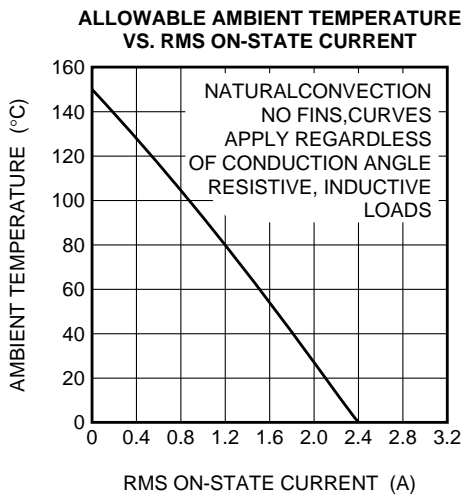
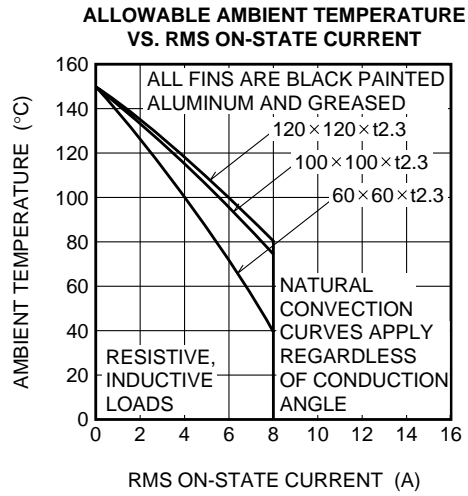
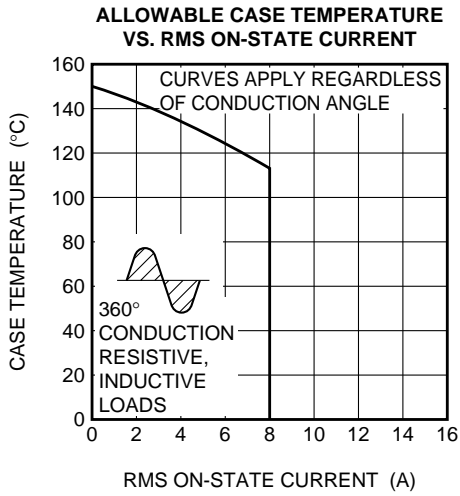

BCR8PM

The product guaranteed maximum junction temperature 150°C (See warning.)

MEDIUM POWER USE
INSULATED TYPE, PLANAR PASSIVATION TYPE

BREAKOVER VOLTAGE VS. JUNCTION TEMPERATURE

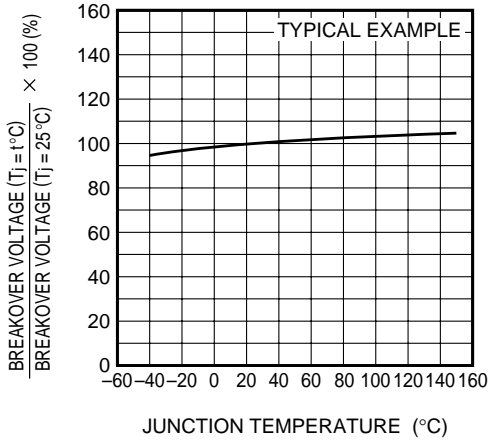

BREAKOVER VOLTAGE VS. RATE OF RISE OF OFF-STATE VOLTAGE (Tj = 125°C)

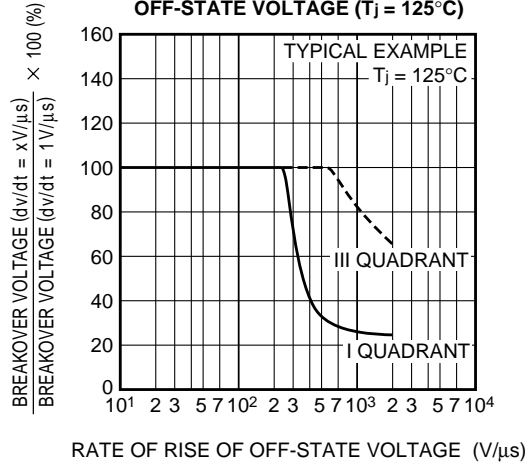

BREAKOVER VOLTAGE VS. RATE OF RISE OF OFF-STATE VOLTAGE (Tj = 150°C)

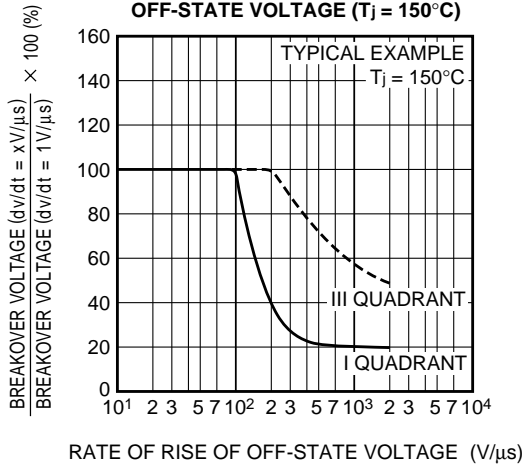

COMMUTATION CHARACTERISTICS (Tj = 125°C)

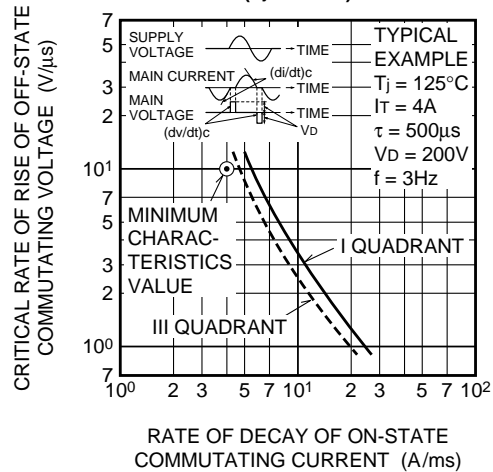

COMMUTATION CHARACTERISTICS (Tj = 150°C)

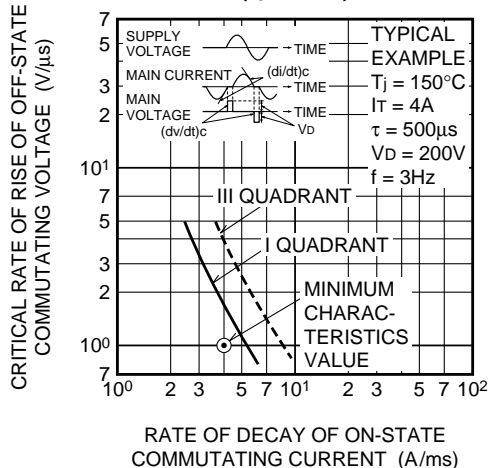

GATE TRIGGER CURRENT VS. GATE CURRENT PULSE WIDTH

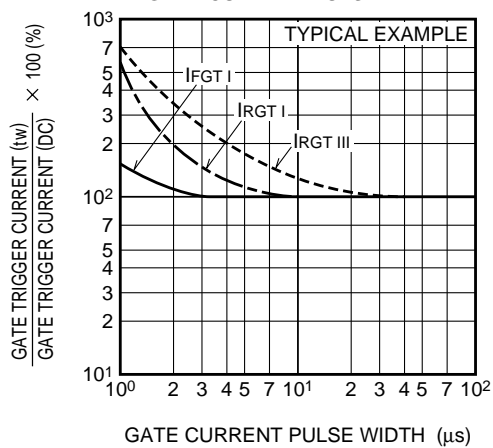

BCR8PM

The product guaranteed maximum junction temperature 150°C (See warning.)

MEDIUM POWER USE
INSULATED TYPE, PLANAR PASSIVATION TYPE

GATE TRIGGER CHARACTERISTICS TEST CIRCUITS

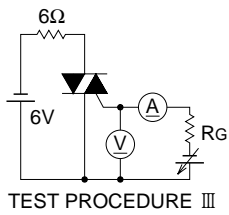
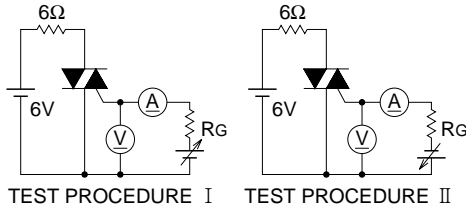

RECOMMENDED CIRCUIT VALUES AROUND THE TRIAC

