

1、Features/特征:

- I Emitting Color/发光颜色: White /白色
- I Lens Type/封装特性: Yellow Diffused/黄色散射
- I Device Outline/外形特征: 5.5×5.0×1.95 (unit:mm)
- I RoHS compliant/符合 RoHS 标准

2、Applications/应用:

- I Backlight for Mobile, Machine Vision, LCD Display/手机、电话、显示屏背光源
- I Backlight in Dashboard and switch of Automive/汽车仪表盘、记程器背光源

3、Outline Dimensions/产品外形尺寸 (units:mm) :

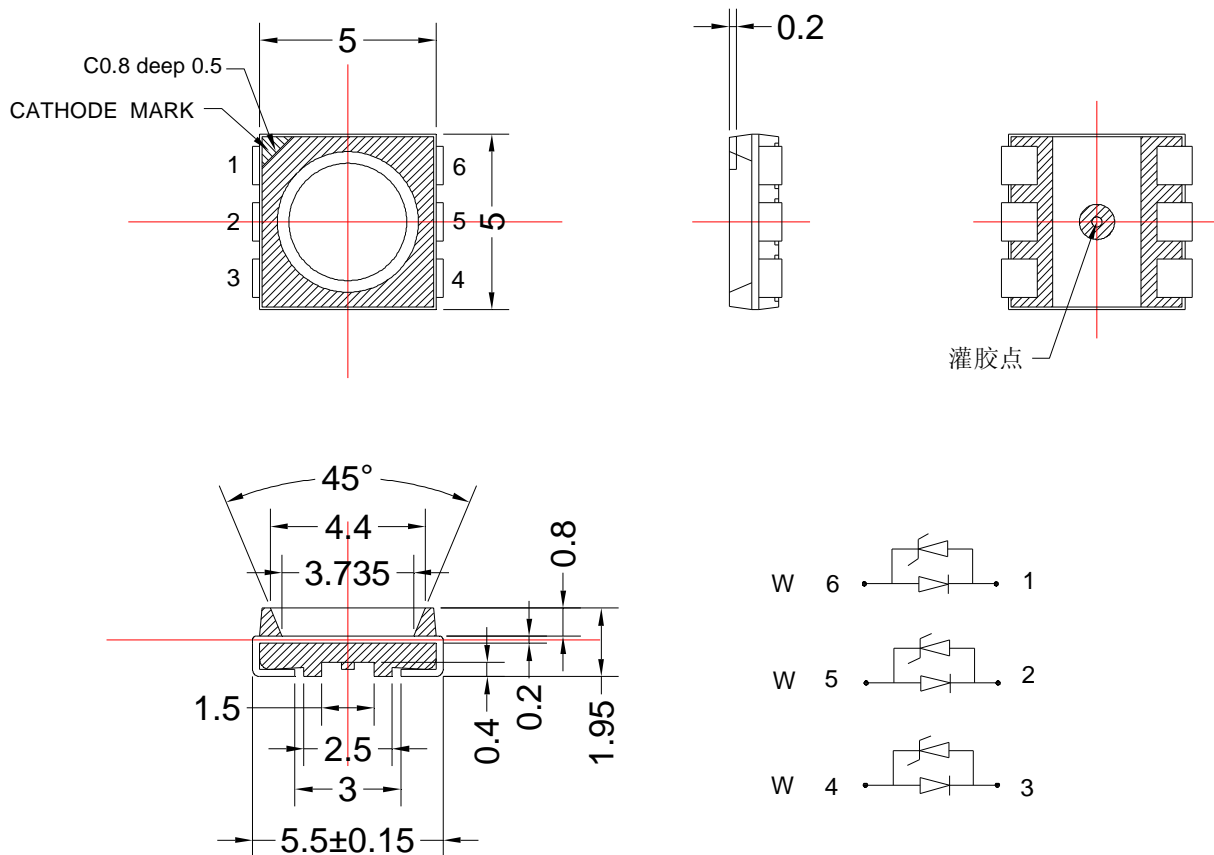

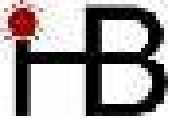

4、Absolute maximum ratings/极限参数 (Ta = 25°C):

Parameter 参数	Color 颜色	Symbol 符号	Test Condition 测试条件	Values 数值		Unit 单位
				Min.	Max.	
Power Dissipation 损耗功率	White	Pd	—	—	95	mW
	White			—	95	
	White			—	95	
Reverse Voltage 反向电压	White	VR	IR = 30 μ A	5	—	V
	White					
	White					
Pulse Current 正向峰值电流	White	IFp	Duty=0.1, 1kHz	—	100	mA
	White					
	White					
Forward Current 正向工作电流	White	IFm	—	—	25	mA
	White					
	White					
Operating Temperature 工作温度范围	White	Topr	—	-40	+85	°C
	White					
	White					
Storage Temperature 储存温度范围	White	Tstr	—	-40	+85	°C
	White					
	White					

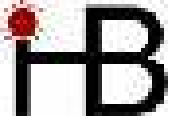

5、Electrical and optical characteristics/光电参数 (Ta = 25℃):

Parameter 参数	Color 颜色	Symbol 符号	Test Condition 测试条件	Values 数值			Unit 单位
				Min	Typ	Max	
Forward Voltage 正向电压	White	VF	IF = 20mA	—	3.3	3.8	V
	White			—	3.3	3.8	
	White			—	3.3	3.8	
Reverse Current 反向电流	White	IR	VR = 5V	—	—	30	μ A
	White			—	—	30	
	White			—	—	30	
Chromaticity coordinates 色坐标	White	CIE-X	IF = 60mA	—	—	—	
		CIE-Y		—	—	—	
Luminous Intensity 发光强度	White	Iv	IF = 20mA	770	1200	—	mcd
	White			770	1200	—	
	White			770	1200	—	
Luminous Intensity 发光强度	White	Iv	IF = 60mA	2130	3500		mcd
Viewing Angle 发光指向角	White	2 θ 1/2	IF = 20mA	—	120	—	Deg.
	White			—	120	—	
	White			—	120	—	

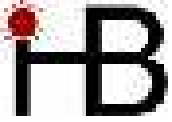

6、Chromaticity coordinates Ranks /色坐标分档:

色坐标误差: ± 0.01

代码	轴	参数				代码	轴	参数			
Wa1	X	0.247	0.253	0.261	0.255	Wa2	X	0.255	0.261	0.269	0.264
	Y	0.236	0.246	0.238	0.228		Y	0.228	0.238	0.229	0.220
Wa3	X	0.253	0.259	0.267	0.261	Wa4	X	0.261	0.267	0.275	0.269
	Y	0.246	0.257	0.248	0.238		Y	0.238	0.248	0.239	0.229
Wa5	X	0.259	0.265	0.273	0.267	Wa6	X	0.267	0.273	0.281	0.275
	Y	0.257	0.267	0.258	0.248		Y	0.248	0.258	0.248	0.239
Wb1	X	0.265	0.269	0.277	0.273	Wb2	X	0.273	0.277	0.285	0.281
	Y	0.267	0.277	0.266	0.258		Y	0.258	0.266	0.255	0.248
Wb3	X	0.269	0.274	0.282	0.277	Wb4	X	0.277	0.282	0.289	0.285
	Y	0.277	0.286	0.274	0.266		Y	0.266	0.274	0.262	0.255
Wb5	X	0.274	0.279	0.286	0.282	Wb6	X	0.282	0.286	0.293	0.289
	Y	0.286	0.295	0.282	0.274		Y	0.274	0.282	0.269	0.262
Wb7	X	0.279	0.284	0.290	0.286	Wb8	X	0.286	0.290	0.297	0.293
	Y	0.295	0.305	0.291	0.282		Y	0.282	0.291	0.276	0.269
Wc1	X	0.284	0.295	0.298	0.288	Wc2	X	0.288	0.298	0.302	0.292
	Y	0.305	0.319	0.308	0.296		Y	0.296	0.308	0.297	0.286
Wc3	X	0.292	0.302	0.305	0.297	Wc4	X	0.295	0.307	0.309	0.298
	Y	0.286	0.297	0.286	0.276		Y	0.319	0.332	0.320	0.308
Wc5	X	0.298	0.309	0.311	0.302	Wc6	X	0.302	0.311	0.313	0.305
	Y	0.308	0.320	0.308	0.297		Y	0.297	0.308	0.296	0.286
Wc7	X	0.307	0.318	0.319	0.309	Wc8	X	0.309	0.319	0.320	0.311
	Y	0.332	0.346	0.333	0.320		Y	0.320	0.333	0.320	0.308
Wc9	X	0.311	0.320	0.322	0.313	Wc10	X	0.318	0.330	0.330	0.319
	Y	0.308	0.320	0.307	0.296		Y	0.346	0.360	0.346	0.333
Wc11	X	0.319	0.330	0.330	0.320	Wc12	X	0.320	0.330	0.330	0.322
	Y	0.333	0.346	0.331	0.320		Y	0.320	0.331	0.317	0.307
Wd1	X	0.330	0.343	0.343	0.330	Wd2	X	0.330	0.343	0.343	0.330
	Y	0.360	0.373	0.358	0.346		Y	0.346	0.358	0.344	0.331
Wd3	X	0.330	0.343	0.343	0.330	Wd4	X	0.343	0.355	0.355	0.343
	Y	0.331	0.344	0.330	0.317		Y	0.373	0.385	0.371	0.358
Wd5	X	0.343	0.355	0.355	0.343	Wd6	X	0.343	0.355	0.355	0.343
	Y	0.358	0.371	0.357	0.344		Y	0.344	0.357	0.343	0.330

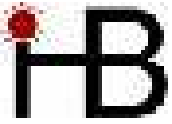

Diagram

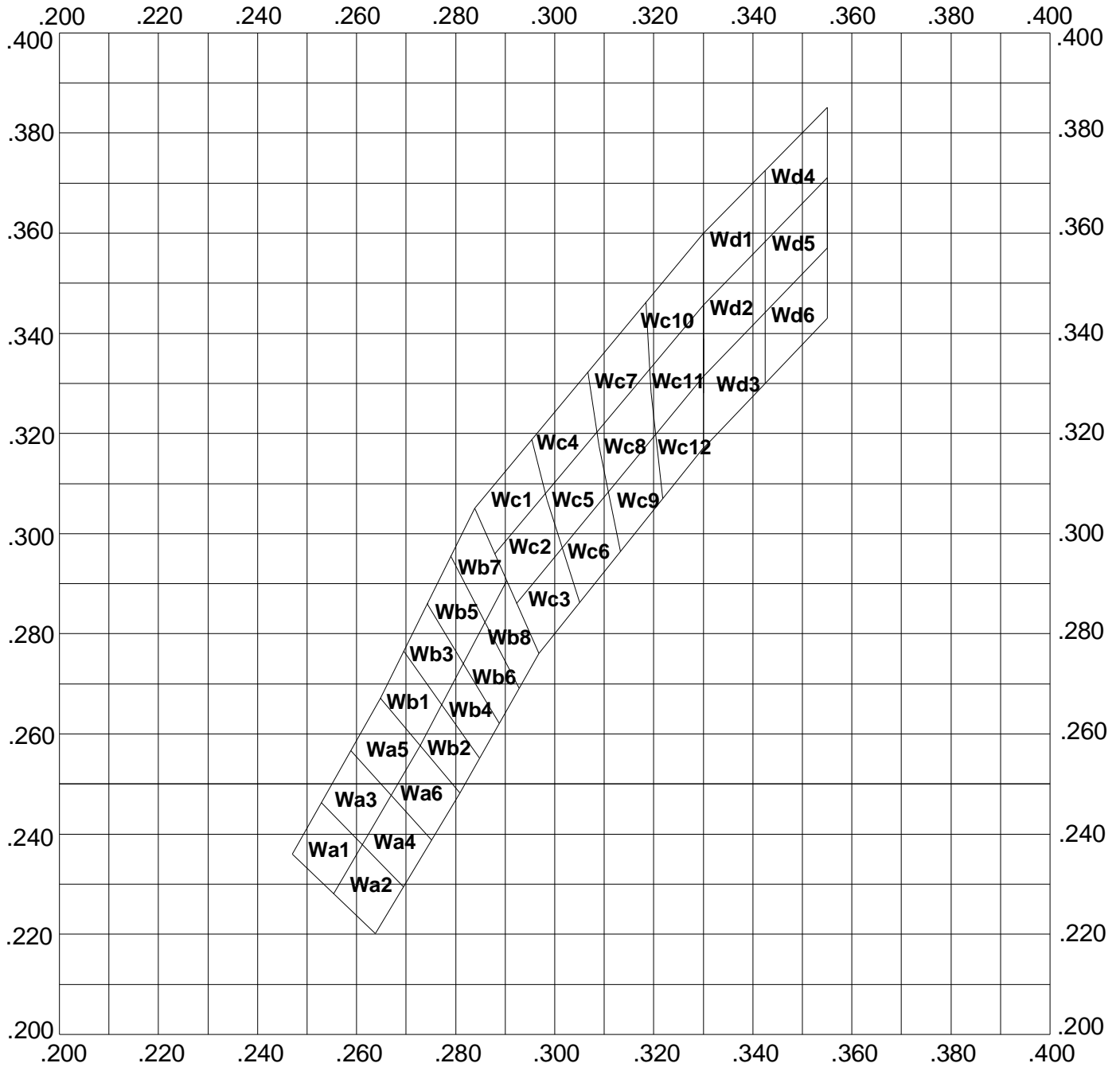

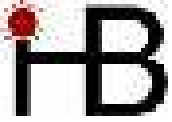

7、Typical electrical/optical characteristic curves/光电特性曲线:

Fig.1 正向电流 Vs. 正向电压

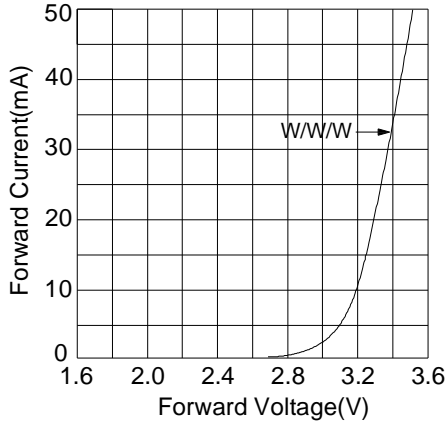

Fig.2 相对亮度 Vs. 正向电流

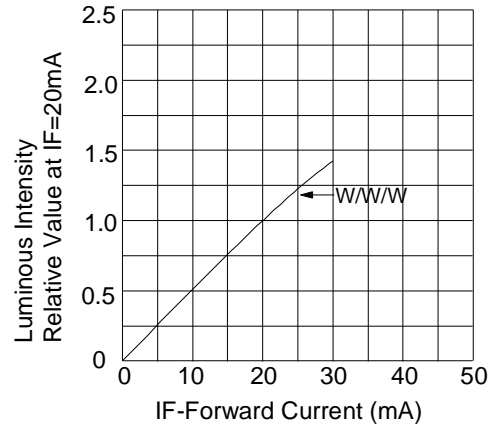

Fig.3 正向电流 Vs. 环境温度

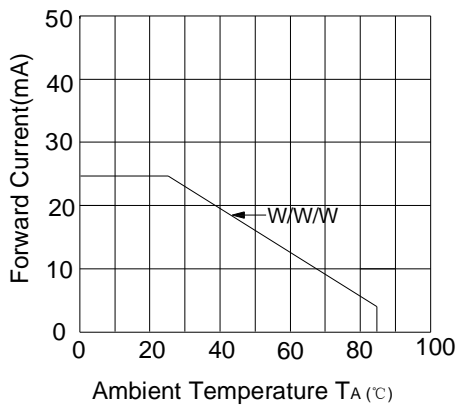
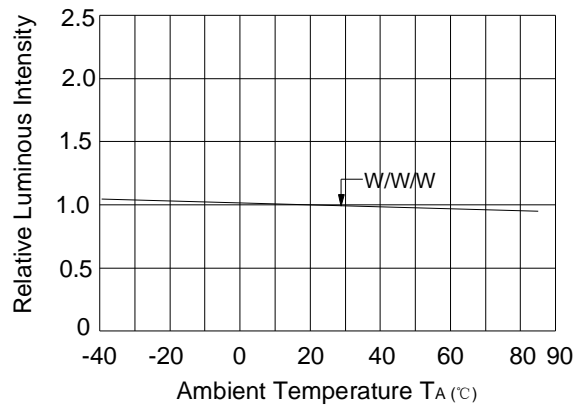
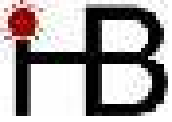

Fig.4 相对亮度 Vs. 环境温度





SMD SPECIFICATION

型号: PLCC6MWC

