



48-Lane 12-Port PCI Express® Switch

89HPES48T12 Data Sheet

Device Overview

The 89HPES48T12 is a member of the IDT PRECISE™ family of PCI Express® switching solutions. The PES48T12 is a 48-lane, 12-port peripheral chip that performs PCI Express packet switching with a feature set optimized for high-performance applications such as servers, storage, and communications/networking. It provides connectivity and switching functions between a PCI Express upstream port and up to eleven downstream ports and supports switching between downstream ports.

Features

- ◆ **High Performance PCI Express Switch**
 - Twelve switch ports
 - Six main ports each of which consists of 8 SerDes
 - Each x8 main port can further bifurcate to 2 x4-ports
- Forty-eight 2.5 Gbps embedded SerDes
- Supports pre-emphasis and receive equalization on per-port basis
- Delivers 192 Gbps (24 GBps) of aggregate switching capacity
- Low-latency cut-through switch architecture
- Support for Max Payload Size up to 2048 bytes

- Supports one virtual channel and eight traffic classes
- PCI Express Base Specification Revision 1.1 compliant
- ◆ **Flexible Architecture with Numerous Configuration Options**
 - Port arbitration schemes utilizing round robin algorithms
 - Automatic per port link width negotiation to x8, x4, x2 or x1
 - Automatic lane reversal on all ports
 - Automatic polarity inversion on all lanes
 - Supports locked transactions, allowing use with legacy software
 - Ability to load device configuration from serial EEPROM
 - Ability to control device via SMBus
- ◆ **Highly Integrated Solution**
 - Requires no external components
 - Incorporates on-chip internal memory for packet buffering and queueing
 - Integrates forty-eight 2.5 Gbps embedded full duplex SerDes, 8B/10B encoder/decoder (no separate transceivers needed)
- ◆ **Reliability, Availability, and Serviceability (RAS) Features**
 - Redundant upstream port failover capability
 - Supports optional PCI Express end-to-end CRC checking

Block Diagram

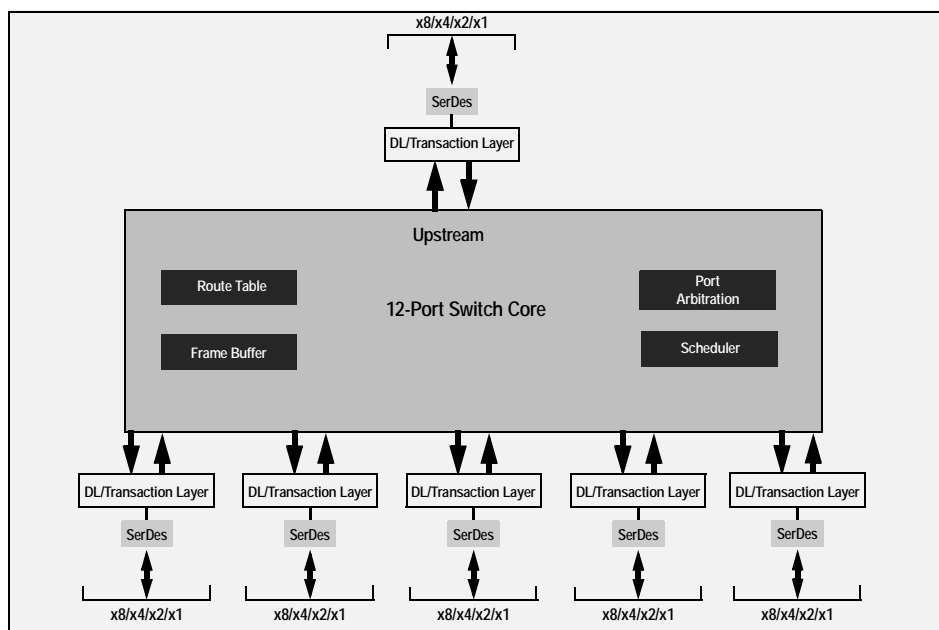

48 PCI Express Lanes
Up to 6 x8 ports or 12 x4 Ports

Figure 1 Internal Block Diagram

- Internal end-to-end parity protection on all TLPs ensures data integrity even in systems that do not implement end-to-end CRC (ECRC)
- Supports optional PCI Express Advanced Error Reporting
- Supports PCI Express Hot-Plug
 - Compatible with Hot-Plug I/O expanders used on PC motherboards
- Supports Hot-Swap
- ◆ **Power Management**
 - Supports PCI Power Management Interface specification, Revision 1.1 (PCI-PM)
 - Supports powerdown modes at the link level (L0, L0s, L1, L2/L3 Ready and L3) and at the device level (D0, D3_{not})
 - Unused SerDes disabled
- ◆ **Testability and Debug Features**
 - Built in SerDes Pseudo-Random Bit Stream (PRBS) generator
 - Ability to read and write any internal register via the SMBus
 - Ability to bypass link training and force any link into any mode
 - Provides statistics and performance counters
- ◆ **32 General Purpose Input/Output pins**
 - Each pin may be individually configured as an input or output
 - Each pin may be individually configured as an interrupt input
 - Some pins have selectable alternate functions
- ◆ **Packaged in a 35mm x 35mm 1156-ball Flip Chip BGA with 1mm ball spacing**

Product Description

Utilizing standard PCI Express interconnect, the PES48T12 provides the most efficient connectivity solution for applications requiring high throughput, low latency, and simple board layout with a minimum number of board layers. It provides 192 Gbps of aggregated switching

capacity through 48 integrated serial lanes, using proven and robust IDT technology. Each lane provides 2.5 Gbps of bandwidth in both directions and is fully compliant with PCI Express Base specification 1.1.

The PES48T12 is based on a flexible and efficient layered architecture. The PCI Express layers consist of SerDes, Physical, Data Link and Transaction layers. The PES48T12 can operate either as a store and forward switch or a cut-through switch and is designed to switch memory and I/O transactions. It supports eight Traffic Classes (TCs) and one Virtual Channel (VC) with sophisticated resource management to enable efficient switching and I/O connectivity.

SMBus Interface

The PES48T12 contains two SMBus interfaces. The slave interface provides full access to the configuration registers in the PES48T12, allowing every configuration register in the device to be read or written by an external agent. The master interface allows the default configuration register values of the PES48T12 to be overridden following a reset with values programmed in an external serial EEPROM. The master interface is also used by an external Hot-Plug I/O expander.

Six pins make up each of the two SMBus interfaces. These pins consist of an SMBus clock pin, an SMBus data pin, and 4 SMBus address pins. In the slave interface, these address pins allow the SMBus address to which the device responds to be configured. In the master interface, these address pins allow the SMBus address of the serial configuration EEPROM from which data is loaded to be configured. The SMBus address is set up on negation of PERSTN by sampling the corresponding address pins. When the pins are sampled, the resulting address is assigned as shown in Table 1.

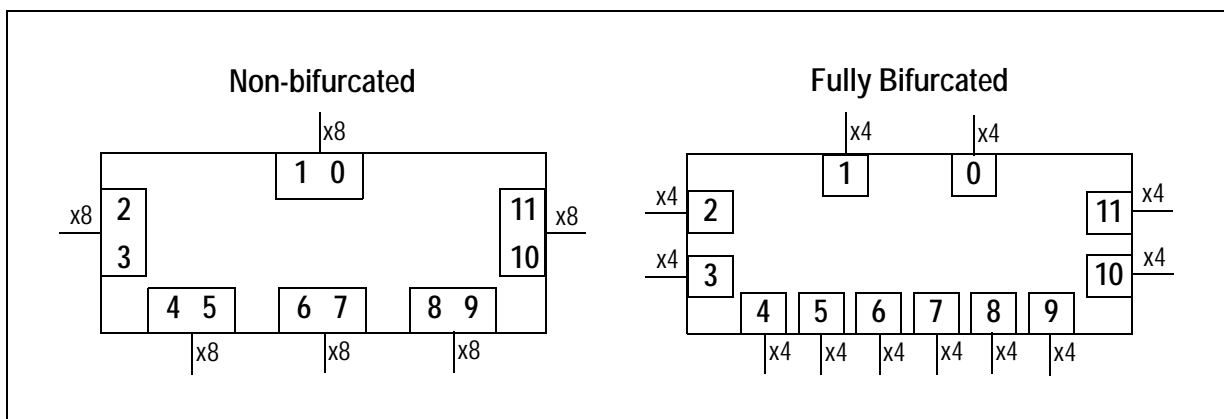

Figure 2 Port Configuration Examples

Note: The configurations in the above diagram show the maximum port widths. The PES48T12 can negotiate to narrower port widths — x4, x2, or x1.

Bit	Slave SMBus Address	Master SMBus Address
1	SSMBADDR[1]	MSMBADDR[1]
2	SSMBADDR[2]	MSMBADDR[2]
3	SSMBADDR[3]	MSMBADDR[3]
4	0	MSMBADDR[4]
5	SSMBADDR[5]	1
6	1	0
7	1	1

Table 1 Master and Slave SMBus Address Assignment

As shown in Figure 3, the master and slave SMBuses may be used in a unified or split configuration. In the unified configuration, shown in Figure 3(a), the master and slave SMBuses are tied together and the PES48T12 acts both as a SMBus master as well as a SMBus slave on this bus. This requires that the SMBus master or processor that has access to PES48T12 registers supports SMBus arbitration. In some systems, this SMBus master interface may be implemented using general purpose I/O pins on a processor or micro controller, and may not support SMBus arbitration. To support these systems, the PES48T12 may be configured to operate in a split configuration as shown in Figure 3(b).

In the split configuration, the master and slave SMBuses operate as two independent buses and thus multi-master arbitration is never required. The PES48T12 supports reading and writing of the serial EEPROM on the master SMBus via the slave SMBus, allowing in system programming of the serial EEPROM.

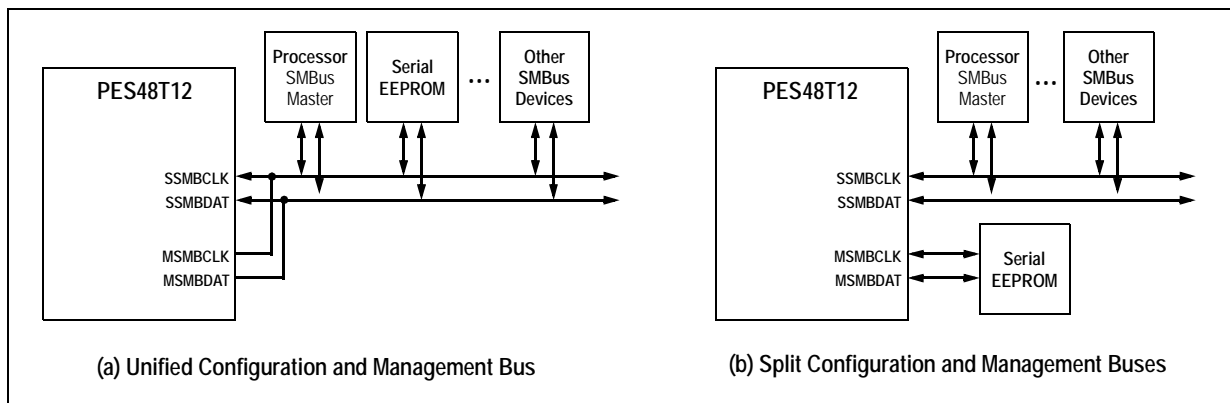

Figure 3 SMBus Interface Configuration Examples

Hot-Plug Interface

The PES48T12 supports PCI Express Hot-Plug on each downstream port. To reduce the number of pins required on the device, the PES48T12 utilizes an external I/O expander, such as that used on PC motherboards, connected to the SMBus master interface. Following reset and configuration, whenever the state of a Hot-Plug output needs to be modified, the PES48T12 generates an SMBus transaction to the I/O expander with the new value of all of the outputs. Whenever a Hot-Plug input changes, the I/O expander generates an interrupt which is received on the IOEXPINTN input pin (alternate function of GPIO) of the PES48T12. In response to an I/O expander interrupt, the PES48T12 generates an SMBus transaction to read the state of all of the Hot-Plug inputs from the I/O expander.

General Purpose Input/Output

The PES48T12 provides 32 General Purpose I/O (GPIO) pins that may be individually configured as general purpose inputs, general purpose outputs, or alternate functions. Some GPIO pins are shared with other on-chip functions. These alternate functions may be enabled via software, SMBus slave interface, or serial configuration EEPROM.

Pin Description

The following tables lists the functions of the pins provided on the PES48T12. Some of the functions listed may be multiplexed onto the same pin. The active polarity of a signal is defined using a suffix. Signals ending with an "N" are defined as being active, or asserted, when at a logic zero (low) level. All other signals (including clocks, buses, and select lines) will be interpreted as being active, or asserted, when at a logic one (high) level. Differential signals end with a suffix "N" or "P." The differential signal ending in "P" is the positive portion of the differential pair and the differential signal ending in "N" is the negative portion of the differential pair.

Signal	Type	Name/Description
PE0RP[3:0] PE0RN[3:0]	I	PCI Express Port 0 Serial Data Receive. Differential PCI Express receive pairs for port 0. Port 0 is the upstream port.
PE0TP[3:0] PE0TN[3:0]	O	PCI Express Port 0 Serial Data Transmit. Differential PCI Express transmit pairs for port 0. Port 0 is the upstream port.
PE1RP[3:0] PE1RN[3:0]	I	PCI Express Port 1 Serial Data Receive. Differential PCI Express receive pairs for port 1. When port 0 is merged with port 1, these signals become port 0 receive pairs for lanes 4 through 7.
PE1TP[3:0] PE1TN[3:0]	O	PCI Express Port 1 Serial Data Transmit. Differential PCI Express transmit pairs for port 1. When port 0 is merged with port 1, these signals become port 0 transmit pairs for lanes 4 through 7.
PE2RP[3:0] PE2RN[3:0]	I	PCI Express Port 2 Serial Data Receive. Differential PCI Express receive pairs for port 2.
PE2TP[3:0] PE2TN[3:0]	O	PCI Express Port 2 Serial Data Transmit. Differential PCI Express transmit pairs for port 2.
PE3RP[3:0] PE3RN[3:0]	I	PCI Express Port 3 Serial Data Receive. Differential PCI Express receive pairs for port 3. When port 2 is merged with port 3, these signals become port 2 receive pairs for lanes 4 through 7.
PE3TP[3:0] PE3TN[3:0]	O	PCI Express Port 3 Serial Data Transmit. Differential PCI Express transmit pairs for port 2. When port 2 is merged with port 3, these signals become port 2 transmit pairs for lanes 4 through 7.
PE4RP[3:0] PE4RN[3:0]	I	PCI Express Port 4 Serial Data Receive. Differential PCI Express receive pairs for port 4.
PE4TP[3:0] PE4TN[3:0]	O	PCI Express Port 4 Serial Data Transmit. Differential PCI Express transmit pairs for port 4.
PE5RP[3:0] PE5RN[3:0]	I	PCI Express Port 5 Serial Data Receive. Differential PCI Express receive pairs for port 5. When port 4 is merged with port 5, these signals become port 4 receive pairs for lanes 4 through 7.
PE5TP[3:0] PE5TN[3:0]	O	PCI Express Port 5 Serial Data Transmit. Differential PCI Express transmit pairs for port 5. When port 4 is merged with port 5, these signals become port 4 transmit pairs for lanes 4 through 7.
PE6RP[3:0] PE6RN[3:0]	I	PCI Express Port 6 Serial Data Receive. Differential PCI Express receive pairs for port 6.
PE6TP[3:0] PE6TN[3:0]	O	PCI Express Port 6 Serial Data Transmit. Differential PCI Express transmit pairs for port 6.
PE7RP[3:0] PE7RN[3:0]	I	PCI Express Port 7 Serial Data Receive. Differential PCI Express receive pairs for port 7. When port 6 is merged with port 7, these signals become port 6 receive pairs for lanes 4 through 7.

Table 2 PCI Express Interface Pins (Part 1 of 2)

Signal	Type	Name/Description
PE7TP[3:0] PE7TN[3:0]	O	PCI Express Port 7 Serial Data Transmit. Differential PCI Express transmit pairs for port 7. When port 6 is merged with port 7, these signals become port 6 transmit pairs for lanes 4 through 7.
PE8RP[3:0] PE8RN[3:0]	I	PCI Express Port 8 Serial Data Receive. Differential PCI Express receive pairs for port 8.
PE8TP[3:0] PE8TN[3:0]	O	PCI Express Port 8 Serial Data Transmit. Differential PCI Express transmit pairs for port 8.
PE9RP[3:0] PE9RN[3:0]	I	PCI Express Port 9 Serial Data Receive. Differential PCI Express receive pairs for port 9. When port 8 is merged with port 9, these signals become port 8 receive pairs for lanes 4 through 7.
PE9TP[3:0] PE9TN[3:0]	O	PCI Express Port 9 Serial Data Transmit. Differential PCI Express transmit pairs for port 9. When port 8 is merged with port 9, these signals become port 8 transmit pairs for lanes 4 through 7.
PE10RP[3:0] PE10RN[3:0]	I	PCI Express Port 10 Serial Data Receive. Differential PCI Express receive pairs for port 10.
PE10TP[3:0] PE10TN[3:0]	O	PCI Express Port 10 Serial Data Transmit. Differential PCI Express transmit pairs for port 10.
PE11RP[3:0] PE11RN[3:0]	I	PCI Express Port 11 Serial Data Receive. Differential PCI Express receive pairs for port 11. When port 10 is merged with port 11, these signals become port 10 receive pairs for lanes 4 through 7.
PE11TP[3:0] PE11TN[3:0]	O	PCI Express Port 11 Serial Data Transmit. Differential PCI Express transmit pairs for port 11. When port 10 is merged with port 11, these signals become port 10 transmit pairs for lanes 4 through 7.
REFCLKM	I	PCI Express Reference Clock Mode Select. This signal selects the frequency of the reference clock input. 0x0 - 100 MHz 0x1 - 125 MHz
REFCLKP[3:0] REFCLKN[3:0]	I	PCI Express Reference Clock. Differential reference clock pair input. This clock is used as the reference clock by on-chip PLLs to generate the clocks required for the system logic and on-chip SerDes. The frequency of the differential reference clock is determined by the REFCLKM signal.

Table 2 PCI Express Interface Pins (Part 2 of 2)

Signal	Type	Name/Description
MSMBADDR[4:1]	I	Master SMBus Address. These pins determine the SMBus address of the serial EEPROM from which configuration information is loaded.
MSMBCLK	I/O	Master SMBus Clock. This bidirectional signal is used to synchronize transfers on the master SMBus. It is active and generating the clock only when the EEPROM or I/O Expanders are being accessed.
MSMBDAT	I/O	Master SMBus Data. This bidirectional signal is used for data on the master SMBus.

Table 3 SMBus Interface Pins (Part 1 of 2)

Signal	Type	Name/Description
SSMBADDR[5,3:1]	I	Slave SMBus Address. These pins determine the SMBus address to which the slave SMBus interface responds.
SSMBCLK	I/O	Slave SMBus Clock. This bidirectional signal is used to synchronize transfers on the slave SMBus.
SSMBDAT	I/O	Slave SMBus Data. This bidirectional signal is used for data on the slave SMBus.

Table 3 SMBus Interface Pins (Part 2 of 2)

Signal	Type	Name/Description
GPIO[0]	I/O	General Purpose I/O. This pin can be configured as a general purpose I/O pin.
GPIO[1]	I/O	General Purpose I/O. This pin can be configured as a general purpose I/O pin.
GPIO[2]	I/O	General Purpose I/O. This pin can be configured as a general purpose I/O pin.
GPIO[3]	I/O	General Purpose I/O. This pin can be configured as a general purpose I/O pin.
GPIO[4]	I/O	General Purpose I/O. This pin can be configured as a general purpose I/O pin.
GPIO[5]	I/O	General Purpose I/O. This pin can be configured as a general purpose I/O pin. Alternate function pin name: GPEN Alternate function pin type: Output Alternate function: General Purpose Event (GPE) output
GPIO[6]	I/O	General Purpose I/O. This pin can be configured as a general purpose I/O pin. Alternate function pin name: P1RSTN Alternate function pin type: Output Alternate function: Reset output for downstream port 1
GPIO[7]	I/O	General Purpose I/O. This pin can be configured as a general purpose I/O pin. Alternate function pin name: P2RSTN Alternate function pin type: Output Alternate function: Reset output for downstream port 2
GPIO[8]	I/O	General Purpose I/O. This pin can be configured as a general purpose I/O pin. Alternate function pin name: P3RSTN Alternate function pin type: Output Alternate function: Reset output for downstream port 3
GPIO[9]	I/O	General Purpose I/O. This pin can be configured as a general purpose I/O pin. Alternate function pin name: P4RSTN Alternate function pin type: Output Alternate function: Reset output for downstream port 4

Table 4 General Purpose I/O Pins (Part 1 of 3)

Signal	Type	Name/Description
GPIO[10]	I/O	General Purpose I/O. This pin can be configured as a general purpose I/O pin. Alternate function pin name: P5RSTN Alternate function pin type: Output Alternate function: Reset output for downstream port 5
GPIO[11]	I/O	General Purpose I/O. This pin can be configured as a general purpose I/O pin. Alternate function pin name: P6RSTN Alternate function pin type: Output Alternate function: Reset output for downstream port 6
GPIO[12]	I/O	General Purpose I/O. This pin can be configured as a general purpose I/O pin. Alternate function pin name: P7RSTN Alternate function pin type: Output Alternate function: Reset output for downstream port 7
GPIO[13]	I/O	General Purpose I/O. This pin can be configured as a general purpose I/O pin. Alternate function pin name: P8RSTN Alternate function pin type: Output Alternate function: Reset output for downstream port 8
GPIO[14]	I/O	General Purpose I/O. This pin can be configured as a general purpose I/O pin. Alternate function pin name: P9RSTN Alternate function pin type: Output Alternate function: Reset output for downstream port 9
GPIO[15]	I/O	General Purpose I/O. This pin can be configured as a general purpose I/O pin. Alternate function pin name: P10RSTN Alternate function pin type: Output Alternate function: Reset output for downstream port 10
GPIO[16]	I/O	General Purpose I/O. This pin can be configured as a general purpose I/O pin. Alternate function pin name: P11RSTN Alternate function pin type: Output Alternate function: Reset output for downstream port 11
GPIO[17]	I/O	General Purpose I/O. This pin can be configured as a general purpose I/O pin.
GPIO[18]	I/O	General Purpose I/O. This pin can be configured as a general purpose I/O pin.
GPIO[19]	I/O	General Purpose I/O. This pin can be configured as a general purpose I/O pin.
GPIO[20]	I/O	General Purpose I/O. This pin can be configured as a general purpose I/O pin.
GPIO[21]	I/O	General Purpose I/O. This pin can be configured as a general purpose I/O pin. Alternate function pin name: IOEXPINTN0 Alternate function pin type: Input Alternate function: SMBus I/O expander interrupt 0

Table 4 General Purpose I/O Pins (Part 2 of 3)

Signal	Type	Name/Description
GPIO[22]	I/O	General Purpose I/O. This pin can be configured as a general purpose I/O pin. Alternate function pin name: IOEXPINTN1 Alternate function pin type: Input Alternate function: SMBus I/O expander interrupt 1
GPIO[23]	I/O	General Purpose I/O. This pin can be configured as a general purpose I/O pin. Alternate function pin name: IOEXPINTN2 Alternate function pin type: Input Alternate function: SMBus I/O expander interrupt 2
GPIO[24]	I/O	General Purpose I/O. This pin can be configured as a general purpose I/O pin. Alternate function pin name: IOEXPINTN3 Alternate function pin type: Input Alternate function: SMBus I/O expander interrupt 3
GPIO[25]	I/O	General Purpose I/O. This pin can be configured as a general purpose I/O pin. Alternate function pin name: IOEXPINTN4 Alternate function pin type: Input Alternate function: SMBus I/O expander interrupt 4
GPIO[26]	I/O	General Purpose I/O. This pin can be configured as a general purpose I/O pin. Alternate function pin name: IOEXPINTN5 Alternate function pin type: Input Alternate function: SMBus I/O expander interrupt 5
GPIO[27]	I/O	General Purpose I/O. This pin can be configured as a general purpose I/O pin.
GPIO[28]	I/O	General Purpose I/O. This pin can be configured as a general purpose I/O pin.
GPIO[29]	I/O	General Purpose I/O. This pin can be configured as a general purpose I/O pin.
GPIO[30]	I/O	General Purpose I/O. This pin can be configured as a general purpose I/O pin.
GPIO[31]	I/O	General Purpose I/O. This pin can be configured as a general purpose I/O pin. Alternate function pin name: IOEXPINTN10 Alternate function pin type: Input Alternate function: SMBus I/O expander interrupt 10.

Table 4 General Purpose I/O Pins (Part 3 of 3)

Signal	Type	Name/Description
CCLKDS	I	Common Clock Downstream. When the CCLKDS pin is asserted, it indicates that a common clock is being used between the downstream device and the downstream port.
CCLKUS	I	Common Clock Upstream. When the CCLKUS pin is asserted, it indicates that a common clock is being used between the upstream device and the upstream port.
MSMBSMODE	I	Master SMBus Slow Mode. The assertion of this pin indicates that the master SMBus should operate at 100 KHz instead of 400 KHz. This value may not be overridden.

Table 5 System Pins (Part 1 of 2)

Signal	Type	Name/Description
P01MERGEN	I	Port 0 and 1 Merge. When this pin is asserted, port 1 is merged with port 0 to form a single x8 port. The SerDes lanes associated with port 1 become lanes 4 through 7 of port 0.
P23MERGEN	I	Port 2 and 3 Merge. When this pin is asserted, port 3 is merged with port 2 to form a single x8 port. The SerDes lanes associated with port 3 become lanes 4 through 7 of port 2.
P45MERGEN	I	Port 4 and 5 Merge. When this pin is asserted, port 5 is merged with port 4 to form a single x8 port. The SerDes lanes associated with port 5 become lanes 4 through 7 of port 4.
P67MERGEN	I	Port 6 and 7 Merge. When this pin is asserted, port 7 is merged with port 6 to form a single x8 port. The SerDes lanes associated with port 7 become lanes 4 through 7 of port 6.
P89MERGEN	I	Port 8 and 9 Merge. When this pin is asserted, port 9 is merged with port 8 to form a single x8 port. The SerDes lanes associated with port 9 become lanes 4 through 7 of port 8.
P1011MERGEN	I	Port 10 and 11 Merge. When this pin is asserted, port 11 is merged with port 10 to form a single x8 port. The SerDes lanes associated with port 11 become lanes 4 through 7 of port 10.
PERSTN	I	Fundamental Reset. Assertion of this signal resets all logic inside the PES48T12 and initiates a PCI Express fundamental reset.
RSTHALT	I	Reset Halt. When this signal is asserted during a PCI Express fundamental reset, PES48T12 executes the reset procedure and remains in a reset state with the Master and Slave SMBuses active. This allows software to read and write registers internal to the device before normal device operation begins. The device exits the reset state when the RSTHALT bit is cleared in the PA_SWCTL register by an SMBus master.
SWMODE[3:0]	I	Switch Mode. These configuration pins determine the PES48T12 switch operating mode. 0x0 - Normal switch mode 0x1 - Normal switch mode with Serial EEPROM initialization 0x2 through 0x7 - Reserved 0x8 - Normal switch mode with upstream port failover (port 0 selected as the upstream port) 0x9 - Normal switch mode with upstream port failover (port 2 selected as the upstream port) 0xA - Normal switch mode with Serial EEPROM initialization and upstream port failover (port 0 selected as the upstream port) 0xB - Normal switch mode with Serial EEPROM initialization and upstream port failover (port 2 selected as the upstream port) 0xC through 0xF - Reserved

Table 5 System Pins (Part 2 of 2)

Signal	Type	Name/Description
JTAG_TCK	I	JTAG Clock. This is an input test clock used to clock the shifting of data into or out of the boundary scan logic or JTAG Controller. JTAG_TCK is independent of the system clock with a nominal 50% duty cycle.
JTAG_TDI	I	JTAG Data Input. This is the serial data input to the boundary scan logic or JTAG Controller.
JTAG_TDO	O	JTAG Data Output. This is the serial data shifted out from the boundary scan logic or JTAG Controller. When no data is being shifted out, this signal is tri-stated.
JTAG_TMS	I	JTAG Mode. The value on this signal controls the test mode select of the boundary scan logic or JTAG Controller.
JTAG_TRST_N	I	JTAG Reset. This active low signal asynchronously resets the boundary scan logic and JTAG TAP Controller. An external pull-up on the board is recommended to meet the JTAG specification in cases where the tester can access this signal. However, for systems running in functional mode, one of the following should occur: 1) actively drive this signal low with control logic 2) statically drive this signal low with an external pull-down on the board

Table 6 Test Pins

Signal	Type	Name/Description
V _{DD} CORE	I	Core VDD. Power supply for core logic.
V _{DD} I/O	I	I/O VDD. LVTTTL I/O buffer power supply.
V _{DD} PE	I	PCI Express Digital Power. PCI Express digital power used by the digital power of the SerDes.
V _{DD} APE	I	PCI Express Analog Power. PCI Express analog power used by the PLL and bias generator.
V _{SS}	I	Ground.
V _{TT} PE	I	PCI Express Serial Data Transmit Termination Voltage. This pin allows the driver termination voltage to be set, enabling the system designer to control the Common Mode Voltage and output voltage swing of the corresponding PCI Serial Data Transmit differential pair.

Table 7 Power and Ground Pins

Pin Characteristics

Note: Some input pads of the PES48T12 do not contain internal pull-ups or pull-downs. Unused inputs should be tied off to appropriate levels. This is especially critical for unused control signal inputs which, if left floating, could adversely affect operation. Also, any input pin left floating can cause a slight increase in power consumption.

Function	Pin Name	Type	Buffer	I/O Type	Internal Resistor	Notes
PCI Express Interface	PE0RN[3:0]	I	CML	Serial Link		
	PE0RP[3:0]	I				
	PE0TN[3:0]	O				
	PE0TP[3:0]	O				
	PE1RN[3:0]	I				
	PE1RP[3:0]	I				
	PE1TN[3:0]	O				
	PE1TP[3:0]	O				
	PE2RN[3:0]	I				
	PE2RP[3:0]	I				
	PE2TN[3:0]	O				
	PE2TP[3:0]	O				
	PE3RN[3:0]	I				
	PE3RP[3:0]	I				
	PE3TN[3:0]	O				
	PE3TP[3:0]	O				
	PE4RN[3:0]	I				
	PE4RP[3:0]	I				
	PE4TN[3:0]	O				
	PE4TP[3:0]	O				
	PE5RN[3:0]	I				
	PE5RP[3:0]	I				
	PE5TN[3:0]	O				
	PE5TP[3:0]	O				
	PE6RN[3:0]	I				
	PE6RP[3:0]	I				
	PE6TN[3:0]	O				
	PE6TP[3:0]	O				
	PE7RN[3:0]	I				
	PE7RP[3:0]	I				
PE7TN[3:0]	O					
PE7TP[3:0]	O					

Table 8 Pin Characteristics (Part 1 of 3)

Function	Pin Name	Type	Buffer	I/O Type	Internal Resistor	Notes	
PCI Express Interface (cont.)	PE8RN[3:0]	I	CML	Serial Link			
	PE8RP[3:0]	I					
	PE8TN[3:0]	O					
	PE8TP[3:0]	O					
	PE9RN[3:0]	I					
	PE9RP[3:0]	I					
	PE9TN[3:0]	O					
	PE9TP[3:0]	O					
	PE10RN[3:0]	I					
	PE10RP[3:0]	I					
	PE10TN[3:0]	O					
	PE10TP[3:0]	O					
	PE11RN[3:0]	I					
	PE11RP[3:0]	I					
	PE11TN[3:0]	O					
	PE11TP[3:0]	O					
		PEREFCLKN[3:0]	I	LVPECL/ CML	Diff. Clock Input		Refer to Table 9
	PEREFCLKP[3:0]	I					
	REFCLKM	I	LVTTTL	Input	pull-down		
SMBus Interface	MSMBADDR[4:1]	I	LVTTTL	STI ¹	pull-up		
	MSMBCLK	I/O		STI			
	MSMBDAT	I/O		STI			
	SSMBADDR[5,3:1]	I			pull-up		
	SSMBCLK	I/O		STI			
	SSMBDAT	I/O		STI			
General Purpose I/O	GPIO[31:0]	I/O	LVTTTL		pull-up		
System Pins	CCLKDS	I	LVTTTL	Input	pull-up		
	CCLKUS	I			pull-up		
	MSMBSMODE	I			pull-down		
	P01MERGEN	I			pull-down		
	P23MERGEN	I			pull-down		
	P45MERGEN	I			pull-down		
	P67MERGEN	I			pull-down		
	P89MERGEN	I			pull-down		
	P1011MERGEN	I			pull-down		
	PERSTN	I					
	RSTHALT	I				pull-down	
	SWMODE[3:0]	I				pull-down	

Table 8 Pin Characteristics (Part 2 of 3)

Function	Pin Name	Type	Buffer	I/O Type	Internal Resistor	Notes
EJTAG / JTAG	JTAG_TCK	I	LVTTTL	STI	pull-up	
	JTAG_TDI	I		STI	pull-up	
	JTAG_TDO	O				
	JTAG_TMS	I		STI	pull-up	
	JTAG_TRST_N	I		STI	pull-up	External pull-down

Table 8 Pin Characteristics (Part 3 of 3)

¹ Schmitt Trigger Input (STI).

Logic Diagram — PES48T12

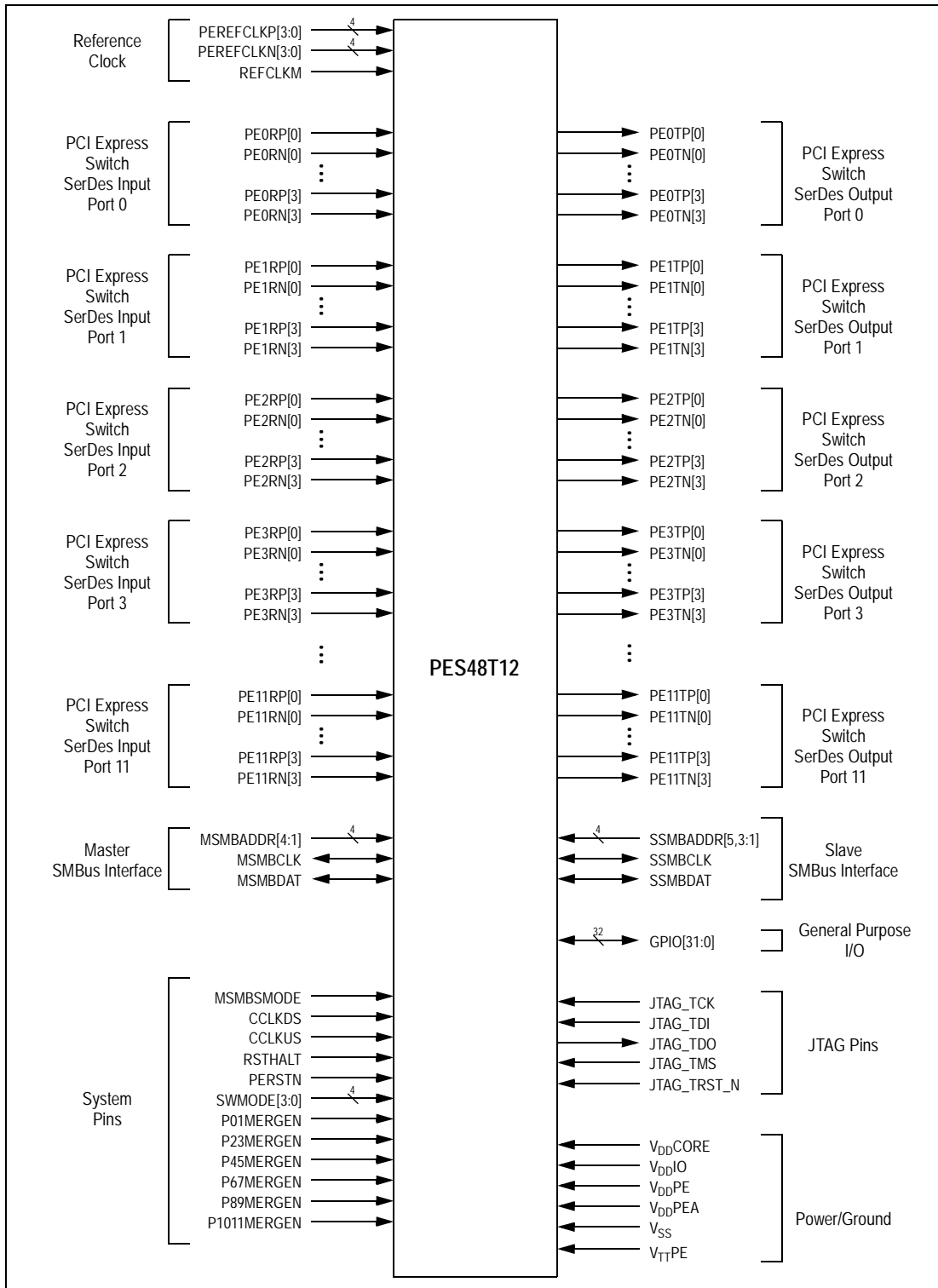

Figure 4 PES48T12 Logic Diagram

System Clock Parameters

Values based on systems running at recommended supply voltages and operating temperatures, as shown in Tables 13 and 14.

Parameter	Description	Min	Typical	Max	Unit
PEREFCLK					
Refclk _{FREQ}	Input reference clock frequency range	100		125 ¹	MHz
Refclk _{DC} ²	Duty cycle of input clock	40	50	60	%
T _R , T _F	Rise/Fall time of input clocks			0.2*RCUI	RCUI ³
V _{SW}	Differential input voltage swing ⁴	0.6		1.6	V
T _{jitter}	Input clock jitter (cycle-to-cycle)			125	ps

Table 9 Input Clock Requirements

- ¹- The input clock frequency will be either 100 or 125 MHz depending on signal REFCLKM.
- ² ClkIn must be AC coupled. Use 0.01 — 0.1 µF ceramic capacitors.
- ³ RCUI (Reference Clock Unit Interval) refers to the reference clock period.
- ⁴ AC coupling required.

AC Timing Characteristics

Parameter	Description	Min ¹	Typical ¹	Max ¹	Units
PCIe Transmit					
UI	Unit Interval	399.88	400	400.12	ps
T _{TX-EYE}	Minimum Tx Eye Width	0.7	.9		UI
T _{TX-EYE-MEDIAN-to-MAX-JITTER}	Maximum time between the jitter median and maximum deviation from the median			0.15	UI
T _{TX-RISE} , T _{TX-FALL}	D+ / D- Tx output rise/fall time	50	90		ps
T _{TX-IDLE-MIN}	Minimum time in idle	50			UI
T _{TX-IDLE-SET-TO-IDLE}	Maximum time to transition to a valid Idle after sending an Idle ordered set			20	UI
T _{TX-IDLE-TO-DIFF-DATA}	Maximum time to transition from valid idle to diff data			20	UI
T _{TX-SKEW}	Transmitter data skew between any 2 lanes		500	1300	ps
PCIe Receive					
UI	Unit Interval	399.88	400	400.12	ps
T _{RX-EYE (with jitter)}	Minimum Receiver Eye Width (jitter tolerance)	0.4			UI
T _{RX-EYE-MEDIUM TO MAX JITTER}	Max time between jitter median & max deviation			0.3	UI
T _{RX-IDLE-DET-DIFF-ENTER TIME}	Unexpected Idle Enter Detect Threshold Integration Time			10	ms
T _{RX-SKEW}	Lane to lane input skew			20	ns

Table 10 PCIe AC Timing Characteristics

- ¹- Minimum, Typical, and Maximum values meet the requirements under PCI Specification 1.1

Signal	Symbol	Reference Edge	Min	Max	Unit	Timing Diagram Reference
GPIO						
GPIO[31:0] ¹	Tpw_13b ²	None	50	—	ns	See Figure 5.

Table 11 GPIO AC Timing Characteristics

¹ GPIO signals must meet the setup and hold times if they are synchronous or the minimum pulse width if they are asynchronous.

² The values for this symbol were determined by calculation, not by testing.

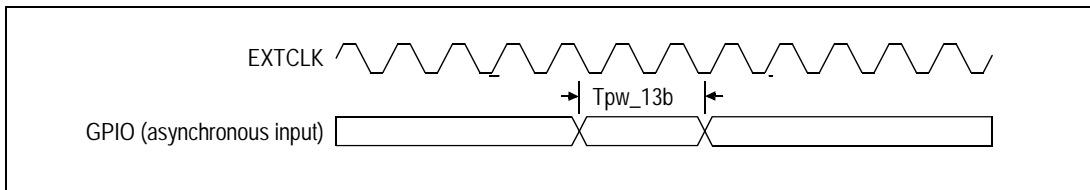

Figure 5 GPIO AC Timing Waveform

Signal	Symbol	Reference Edge	Min	Max	Unit	Timing Diagram Reference
JTAG						
JTAG_TCK	Tper_16a	none	50.0	—	ns	See Figure 6.
	Thigh_16a, Tlow_16a		10.0	25.0	ns	
JTAG_TMS ¹ , JTAG_TDI	Tsu_16b	JTAG_TCK rising	2.4	—	ns	
	Thld_16b		1.0	—	ns	
JTAG_TDO	Tdo_16c	JTAG_TCK falling	—	20	ns	
	Tdz_16c ²		—	20	ns	
JTAG_TRST_N	Tpw_16d ²	none	25.0	—	ns	

Table 12 JTAG AC Timing Characteristics

¹ The JTAG specification, IEEE 1149.1, recommends that JTAG_TMS should be held at 1 while the signal applied at JTAG_TRST_N changes from 0 to 1. Otherwise, a race may occur if JTAG_TRST_N is deasserted (going from low to high) on a rising edge of JTAG_TCK when JTAG_TMS is low, because the TAP controller might go to either the Run-Test/Idle state or stay in the Test-Logic-Reset state.

² The values for this symbol were determined by calculation, not by testing.

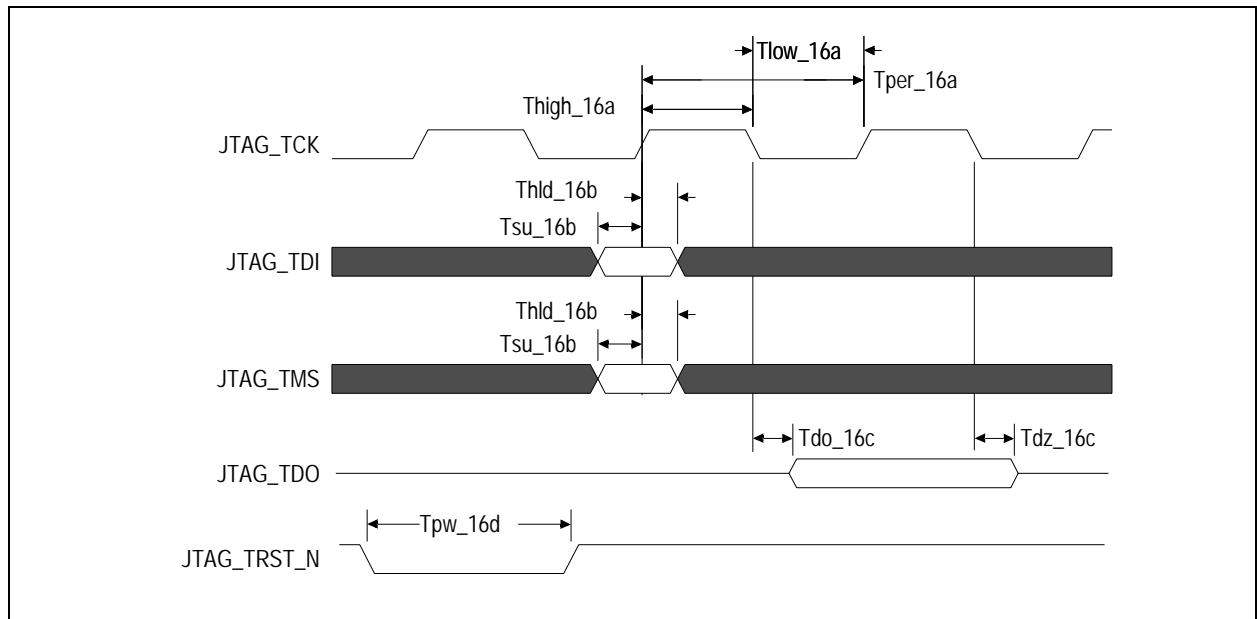

Figure 6 JTAG AC Timing Waveform

Recommended Operating Supply Voltages

Symbol	Parameter	Minimum	Typical	Maximum	Unit
V _{DD} CORE	Internal logic supply	0.9	1.0	1.1	V
V _{DD} I/O	I/O supply except for SerDes LVPECL/CML	3.0	3.3	3.6	V
V _{DD} PE	PCI Express Digital Power	0.9	1.0	1.1	V
V _{DD} APE	PCI Express Analog Power	0.9	1.0	1.1	V
V _{TT} PE	PCI Express Serial Data Transmit Termination Voltage	1.425	1.5	1.575	V
V _{SS}	Common ground	0	0	0	V

Table 13 PES48T12 Operating Voltages

Power-Up Sequence

This section describes the sequence in which various voltages must be applied to the part during power-up to ensure proper functionality. For the PES48T12, the power-up sequence must be as follows:

1. V_{DD}I/O — 3.3V
2. V_{DD}Core, V_{DD}PE, V_{DD}APE — 1.0V
3. V_{TT}PE — 1.5V

When powering up, each voltage level must ramp and stabilize prior to applying the next voltage in the sequence to ensure internal latch-up issues are avoided. There are no maximum time limitations in ramping to valid power levels. The power-down sequence must be in the reverse order of the power-up sequence.

Recommended Operating Temperature

Grade	Temperature
Commercial	0°C to +70°C Ambient
Industrial	-40°C to +85°C Ambient

Table 14 PES48T12 Operating Temperatures

Power Consumption

Typical power is measured under the following conditions: 25°C Ambient, 35% total link usage on all ports, typical voltages defined in Table 13 (and also listed below).

Maximum power is measured under the following conditions: 70°C Ambient, 85% total link usage on all ports, maximum voltages defined in Table 13 (and also listed below).

Number of active Lanes per Port		Core Supply		PCIe Digital Supply		PCIe Analog Supply		PCIe Termination Supply		I/O Supply		Total	
		Typ 1.0V	Max 1.1V	Typ 1.0V	Max 1.1V	Typ 1.0V	Max 1.1V	Typ 1.5V	Max 1.575V	Typ 3.3V	Max 3.6V	Typ Power	Max Power
8/8/8/8/8/8	mA	2141	2635	2155	2657	918	1127	1076	1327	3.8	3.8	6.85W	9.16W
	Watts	2.14	2.89	2.15	2.92	0.91	1.24	1.6	2.09	0.01	0.01		

Table 15 PES48T12 Power Consumption

Thermal Considerations

This section describes thermal considerations for the PES48T12 (35mm² FCBGA1156 package). The data in Table 16 below contains information that is relevant to the thermal performance of the PES48T12 switch.

Symbol	Parameter	Value	Units	Conditions
T _{J(max)}	Junction Temperature	125	°C	Maximum
T _{A(max)}	Ambient Temperature	70	°C	Maximum
θ _{JC}	Thermal Resistance, Junction-to-Case	0.2	°C/W	
P	Power Dissipation of the Device	9.16	Watts	Maximum

Table 16 Thermal Specifications for PES48T12, 35x35 mm FCBGA1156 Package

Note: It is important for the reliability of this device in any user environment that the junction temperature not exceed the T_{J(max)} value specified in Table 16. Consequently, the effective junction to ambient thermal resistance (θ_{JA}) for the worst case scenario must be maintained below the value determined by the formula:

$$\theta_{JA} = (T_{J(max)} - T_{A(max)})/P$$

Given that the values of T_{J(max)}, T_{A(max)}, and P are known, the value of desired θ_{JA} becomes a known entity to the system designer. How to achieve the desired θ_{JA} is left up to the board or system designer, but in general, it can be achieved by adding the effects of θ_{JC} (value provided in Table 16), thermal resistance of the chosen adhesive (θ_{CS}), that of the heat sink (θ_{SA}), amount of airflow, and properties of the circuit board (number of layers and size of the board). As a general guideline, this device will not need a heat sink if the board has 10 or more layers AND the board size is larger than 4"x12" AND airflow in excess of 1 m/s is available. It is strongly recommended that users perform their own thermal analysis for their own board and system design scenarios.

DC Electrical Characteristics

Values based on systems running at recommended supply voltages, as shown in Table 13.

Note: See Table 8, Pin Characteristics, for a complete I/O listing.

I/O Type	Parameter	Description	Min ¹	Typ ¹	Max ¹	Unit	Conditions
Serial Link	PCIe Transmit						
	V _{TX-DIFFp-p}	Differential peak-to-peak output voltage	800		1200	mV	
	V _{TX-DE-RATIO}	De-emphasized differential output voltage	-3		-4	dB	
	V _{TX-DC-CM}	DC Common mode voltage	-0.1	1	3.7	V	
	V _{TX-CM-ACP}	RMS AC peak common mode output voltage			20	mV	
	V _{TX-CM-DC-active-idle-delta}	Abs delta of DC common mode voltage between LO and idle			100	mV	
	V _{TX-CM-DC-line-delta}	Abs delta of DC common mode voltage between D+ and D-			25	mV	
	V _{TX-Idle-DiffP}	Electrical idle diff peak output			20	mV	
	V _{TX-RCV-Detect}	Voltage change during receiver detection			600	mV	
	RL _{TX-DIFF}	Transmitter Differential Return loss	12			dB	
	RL _{TX-CM}	Transmitter Common Mode Return loss	6			dB	
	Z _{TX-DEFF-DC}	DC Differential TX impedance	80	100	120	Ω	
	Z _{OSE}	Single ended TX Impedance	40	50	60	Ω	
	Transmitter Eye Diagram	TX Eye Height (De-emphasized bits)	505	650		mV	
	Transmitter Eye Diagram	TX Eye Height (Transition bits)	800	950		mV	
	PCIe Receive						
	V _{RX-DIFFp-p}	Differential input voltage (peak-to-peak)	175		1200	mV	
	V _{RX-CM-AC}	Receiver common-mode voltage for AC coupling			150	mV	
	RL _{RX-DIFF}	Receiver Differential Return Loss	15			dB	
	RL _{RX-CM}	Receiver Common Mode Return Loss	6			dB	
Z _{RX-DIFF-DC}	Differential input impedance (DC)	80	100	120	Ω		
Z _{RX-COMM-DC}	Single-ended input impedance	40	50	60	Ω		
Z _{RX-COMM-HIGH-Z-DC}	Powered down input common mode impedance (DC)	200k	350k		Ω		
V _{RX-IDLE-DET-DIFFp-p}	Electrical idle detect threshold	65		175	mV		
PCIe REFCLK							
	C _{IN}	Input Capacitance	1.5	—		pF	

Table 17 DC Electrical Characteristics (Part 1 of 2)

I/O Type	Parameter	Description	Min ¹	Typ ¹	Max ¹	Unit	Conditions
Other I/Os							
LOW Drive Output	I_{OL}		—	2.5	—	mA	$V_{OL} = 0.4v$
	I_{OH}		—	-5.5	—	mA	$V_{OH} = 1.5V$
High Drive Output	I_{OL}		—	12.0	—	mA	$V_{OL} = 0.4v$
	I_{OH}		—	-20.0	—	mA	$V_{OH} = 1.5V$
Schmitt Trigger Input (STI)	V_{IL}		-0.3	—	0.8	V	—
	V_{IH}		2.0	—	$V_{DD}I/O + 0.5$	V	—
Input	V_{IL}		-0.3	—	0.8	V	—
	V_{IH}		2.0	—	$V_{DD}I/O + 0.5$	V	—
Capacitance	C_{IN}		—	—	8.5	pF	—
Leakage	Inputs		—	—	± 10	μA	$V_{DD}I/O$ (max)
	I/O_{LEAK} W/O Pull-ups/downs		—	—	± 10	μA	$V_{DD}I/O$ (max)
	I/O_{LEAK} WITH Pull-ups/downs		—	—	± 80	μA	$V_{DD}I/O$ (max)

Table 17 DC Electrical Characteristics (Part 2 of 2)

¹. Minimum, Typical, and Maximum values meet the requirements under PCI Specification 1.0a.

Package Pinout — 1156-BGA Signal Pinout for PES48T12

The following table lists the pin numbers and signal names for the PES48T12 device.

Pin	Function	Alt	Pin	Function	Alt	Pin	Function	Alt	Pin	Function	Alt
A1	V _{SS}		B1	V _{SS}		C1	GPIO_29		D1	GPIO_28	
A2	V _{SS}		B2	V _{DDIO}		C2	GPIO_27		D2	GPIO_26	1
A3	GPIO_19		B3	GPIO_18		C3	GPIO_21	1	D3	V _{DDIO}	
A4	V _{DDIO}		B4	GPIO_17		C4	GPIO_16	1	D4	GPIO_23	1
A5	V _{SS}		B5	V _{SS}		C5	V _{SS}		D5	V _{SS}	
A6	PE9TP03		B6	PE9TN03		C6	V _{SS}		D6	PE9RP03	
A7	PE9TP02		B7	PE9TN02		C7	V _{SS}		D7	PE9RP02	
A8	V _{SS}		B8	V _{SS}		C8	V _{SS}		D8	V _{SS}	
A9	PE9TP01		B9	PE9TN01		C9	V _{SS}		D9	PE9RP01	
A10	PE9TP00		B10	PE9TN00		C10	V _{SS}		D10	PE9RP00	
A11	V _{SS}		B11	V _{SS}		C11	V _{SS}		D11	V _{SS}	
A12	PE8TP03		B12	PE8TN03		C12	V _{SS}		D12	PE8RP03	
A13	PE8TP02		B13	PE8TN02		C13	V _{SS}		D13	PE8RP02	
A14	V _{SS}		B14	V _{SS}		C14	V _{SS}		D14	V _{SS}	
A15	PE8TP01		B15	PE8TN01		C15	V _{SS}		D15	PE8RP01	
A16	PE8TP00		B16	PE8TN00		C16	V _{SS}		D16	PE8RP00	
A17	V _{SS}		B17	V _{SS}		C17	V _{SS}		D17	V _{SS}	
A18	PE3TP03		B18	PE3TN03		C18	V _{SS}		D18	PE3RP03	
A19	PE3TP02		B19	PE3TN02		C19	V _{SS}		D19	PE3RP02	
A20	V _{SS}		B20	V _{SS}		C20	V _{SS}		D20	V _{SS}	
A21	PE3TP01		B21	PE3TN01		C21	V _{SS}		D21	PE3RP01	
A22	PE3TP00		B22	PE3TN00		C22	V _{SS}		D22	PE3RP00	
A23	V _{SS}		B23	V _{SS}		C23	V _{SS}		D23	V _{SS}	
A24	PE2TP03		B24	PE2TN03		C24	V _{SS}		D24	PE2RP03	
A25	PE2TP02		B25	PE2TN02		C25	V _{SS}		D25	PE2RP02	
A26	V _{SS}		B26	V _{SS}		C26	V _{SS}		D26	V _{SS}	
A27	PE2TP01		B27	PE2TN01		C27	V _{SS}		D27	PE2RP01	
A28	PE2TP00		B28	PE2TN00		C28	V _{SS}		D28	PE2RP00	
A29	V _{SS}		B29	V _{SS}		C29	V _{SS}		D29	V _{SS}	
A30	V _{DDIO}		B30	MSMBADDR_3		C30	MSMBADDR_4		D30	JTAG_TMS	
A31	MSMBADDR_1		B31	MSMBADDR_2		C31	JTAG_TDI		D31	V _{DDIO}	
A32	MSMBSMODE		B32	PERSTN		C32	JTAG_TRST_N		D32	SSMBADDR_5	
A33	V _{SS}		B33	V _{DDIO}		C33	SSMBADDR_2		D33	SSMBADDR_3	
A34	V _{SS}		B34	V _{SS}		C34	SSMBADDR_1		D34	V _{DDIO}	

Table 18 PES48T12 1156-pin Signal Pin-Out (Part 1 of 9)

Pin	Function	Alt	Pin	Function	Alt	Pin	Function	Alt	Pin	Function	Alt
E1	V _{DD} IO		F1	V _{SS}		G1	PE10TP00		H1	PE10TP01	
E2	GPIO_30		F2	V _{SS}		G2	PE10TN00		H2	PE10TN01	
E3	GPIO_31	1	F3	V _{SS}		G3	V _{SS}		H3	V _{SS}	
E4	GPIO_24	1	F4	V _{SS}		G4	PE10RP00		H4	PE10RP01	
E5	V _{SS}		F5	V _{SS}		G5	PE10RN00		H5	PE10RN01	
E6	PE9RN03		F6	V _{SS}		G6	V _{SS}		H6	V _{SS}	
E7	PE9RN02		F7	V _{SS}		G7	V _{SS}		H7	V _{SS}	
E8	V _{SS}		F8	V _{SS}		G8	V _{SS}		H8	GPIO_20	
E9	PE9RN01		F9	V _{SS}		G9	V _{SS}		H9	V _{DD} IO	
E10	PE9RN00		F10	V _{SS}		G10	V _{SS}		H10	V _{SS}	
E11	V _{SS}		F11	V _{SS}		G11	V _{SS}		H11	V _{SS}	
E12	PE8RN03		F12	V _{SS}		G12	V _{SS}		H12	V _{SS}	
E13	PE8RN02		F13	V _{SS}		G13	V _{SS}		H13	V _{TT} PE	
E14	V _{SS}		F14	V _{SS}		G14	V _{SS}		H14	V _{SS}	
E15	PE8RN01		F15	V _{SS}		G15	V _{SS}		H15	V _{DD} APE	
E16	PE8RN00		F16	V _{SS}		G16	V _{SS}		H16	V _{SS}	
E17	V _{SS}		F17	V _{SS}		G17	PEREFCLKP1		H17	V _{SS}	
E18	PE3RN03		F18	V _{SS}		G18	PEREFCLKN1		H18	V _{SS}	
E19	PE3RN02		F19	V _{SS}		G19	V _{SS}		H19	V _{SS}	
E20	V _{SS}		F20	V _{SS}		G20	V _{SS}		H20	V _{DD} APE	
E21	PE3RN01		F21	V _{SS}		G21	V _{SS}		H21	V _{SS}	
E22	PE3RN00		F22	V _{SS}		G22	V _{SS}		H22	V _{TT} PE	
E23	V _{SS}		F23	V _{SS}		G23	V _{SS}		H23	V _{SS}	
E24	PE2RN03		F24	V _{SS}		G24	V _{SS}		H24	V _{SS}	
E25	PE2RN02		F25	V _{SS}		G25	V _{SS}		H25	V _{SS}	
E26	V _{SS}		F26	V _{SS}		G26	V _{SS}		H26	MSMBDAT	
E27	PE2RN01		F27	V _{SS}		G27	MSMBCLK		H27	V _{DD} IO	
E28	PE2RN00		F28	V _{SS}		G28	V _{SS}		H28	SSMBCLK	
E29	V _{SS}		F29	V _{SS}		G29	V _{SS}		H29	V _{SS}	
E30	V _{SS}		F30	PE1RN03		G30	PE1RN02		H30	V _{SS}	
E31	V _{SS}		F31	PE1RP03		G31	PE1RP02		H31	V _{SS}	
E32	V _{SS}		F32	V _{SS}		G32	V _{SS}		H32	V _{SS}	
E33	V _{SS}		F33	PE1TN03		G33	PE1TN02		H33	V _{SS}	
E34	V _{SS}		F34	PE1TP03		G34	PE1TP02		H34	V _{SS}	

Table 18 PES48T12 1156-pin Signal Pin-Out (Part 2 of 9)

Pin	Function	Alt	Pin	Function	Alt	Pin	Function	Alt	Pin	Function	Alt
J1	V _{SS}		K1	PE10TP02		L1	PE10TP03		M1	V _{SS}	
J2	V _{SS}		K2	PE10TN02		L2	PE10TN03		M2	V _{SS}	
J3	V _{SS}		K3	V _{SS}		L3	V _{SS}		M3	V _{SS}	
J4	V _{SS}		K4	PE10RP02		L4	PE10RP03		M4	V _{SS}	
J5	V _{SS}		K5	PE10RN02		L5	PE10RN03		M5	V _{SS}	
J6	V _{SS}		K6	V _{SS}		L6	V _{SS}		M6	V _{SS}	
J7	V _{SS}		K7	V _{SS}		L7	V _{SS}		M7	V _{SS}	
J8	V _{SS}		K8	V _{SS}		L8	V _{SS}		M8	V _{SS}	
J9	GPIO_25	1	K9	V _{DD} IO		L9	V _{SS}		M9	V _{SS}	
J10	V _{SS}		K10	GPIO_22	1	L10	V _{SS}		M10	V _{SS}	
J11	V _{SS}		K11	V _{SS}		L11	V _{SS}		M11	V _{SS}	
J12	V _{SS}		K12	V _{SS}		L12	V _{SS}		M12	V _{SS}	
J13	V _{SS}		K13	V _{TT} PE		L13	V _{DD} PE		M13	V _{DD} PE	
J14	V _{DD} PE		K14	V _{SS}		L14	V _{DD} PE		M14	V _{SS}	
J15	V _{SS}		K15	V _{DD} APE		L15	V _{DD} PE		M15	V _{DD} PE	
J16	V _{SS}		K16	V _{SS}		L16	V _{SS}		M16	V _{SS}	
J17	V _{TT} PE		K17	V _{TT} PE		L17	V _{DD} PE		M17	V _{DD} PE	
J18	V _{TT} PE		K18	V _{TT} PE		L18	V _{DD} PE		M18	V _{DD} PE	
J19	V _{SS}		K19	V _{SS}		L19	V _{SS}		M19	V _{SS}	
J20	V _{SS}		K20	V _{DD} APE		L20	V _{DD} PE		M20	V _{DD} PE	
J21	V _{DD} PE		K21	V _{SS}		L21	V _{DD} PE		M21	V _{SS}	
J22	V _{SS}		K22	V _{TT} PE		L22	V _{DD} PE		M22	V _{DD} PE	
J23	V _{SS}		K23	V _{SS}		L23	V _{SS}		M23	V _{SS}	
J24	V _{SS}		K24	V _{SS}		L24	V _{SS}		M24	V _{SS}	
J25	JTAG_TDO		K25	CCLKDS		L25	V _{SS}		M25	V _{SS}	
J26	V _{DD} IO		K26	JTAG_TCK		L26	V _{SS}		M26	V _{SS}	
J27	SSMBDAT		K27	V _{SS}		L27	V _{SS}		M27	V _{SS}	
J28	V _{SS}		K28	V _{SS}		L28	V _{SS}		M28	V _{SS}	
J29	V _{SS}		K29	V _{SS}		L29	V _{SS}		M29	V _{SS}	
J30	PE1RN01		K30	PE1RN00		L30	V _{SS}		M30	PE0RN03	
J31	PE1RP01		K31	PE1RP00		L31	V _{SS}		M31	PE0RP03	
J32	V _{SS}		K32	V _{SS}		L32	V _{SS}		M32	V _{SS}	
J33	PE1TN01		K33	PE1TN00		L33	V _{SS}		M33	PE0TN03	
J34	PE1TP01		K34	PE1TP00		L34	V _{SS}		M34	PE0TP03	

Table 18 PES48T12 1156-pin Signal Pin-Out (Part 3 of 9)

Pin	Function	Alt	Pin	Function	Alt	Pin	Function	Alt	Pin	Function	Alt
N1	PE11TP00		P1	PE11TP01		R1	V _{SS}		T1	PE11TP02	
N2	PE11TN00		P2	PE11TN01		R2	V _{SS}		T2	PE11TN02	
N3	V _{SS}		P3	V _{SS}		R3	V _{SS}		T3	V _{SS}	
N4	PE11RP00		P4	PE11RP01		R4	V _{SS}		T4	PE11RP02	
N5	PE11RN00		P5	PE11RN01		R5	V _{SS}		T5	PE11RN02	
N6	V _{SS}		P6	V _{SS}		R6	V _{SS}		T6	V _{SS}	
N7	V _{SS}		P7	V _{SS}		R7	V _{SS}		T7	V _{SS}	
N8	V _{TT} PE		P8	V _{SS}		R8	V _{DD} APE		T8	V _{SS}	
N9	V _{SS}		P9	V _{DD} PE		R9	V _{SS}		T9	V _{SS}	
N10	V _{TT} PE		P10	V _{SS}		R10	V _{DD} APE		T10	V _{SS}	
N11	V _{DD} PE		P11	V _{DD} PE		R11	V _{DD} PE		T11	V _{SS}	
N12	V _{DD} PE		P12	V _{SS}		R12	V _{DD} PE		T12	V _{SS}	
N13	V _{DD} CORE		P13	V _{DD} CORE		R13	V _{DD} CORE		T13	V _{SS}	
N14	V _{DD} CORE		P14	V _{SS}		R14	V _{DD} CORE		T14	V _{SS}	
N15	V _{DD} CORE		P15	V _{DD} CORE		R15	V _{SS}		T15	V _{DD} CORE	
N16	V _{SS}		P16	V _{SS}		R16	V _{DD} CORE		T16	V _{SS}	
N17	V _{DD} CORE		P17	V _{DD} CORE		R17	V _{SS}		T17	V _{DD} CORE	
N18	V _{SS}		P18	V _{SS}		R18	V _{DD} CORE		T18	V _{SS}	
N19	V _{DD} CORE		P19	V _{DD} CORE		R19	V _{SS}		T19	V _{DD} CORE	
N20	V _{DD} CORE		P20	V _{SS}		R20	V _{DD} CORE		T20	V _{SS}	
N21	V _{DD} CORE		P21	V _{DD} CORE		R21	V _{SS}		T21	V _{DD} CORE	
N22	V _{DD} CORE		P22	V _{DD} CORE		R22	V _{DD} CORE		T22	V _{DD} CORE	
N23	V _{DD} PE		P23	V _{SS}		R23	V _{DD} PE		T23	V _{SS}	
N24	V _{DD} PE		P24	V _{DD} PE		R24	V _{DD} PE		T24	V _{SS}	
N25	V _{TT} PE		P25	V _{SS}		R25	V _{DD} APE		T25	V _{SS}	
N26	V _{SS}		P26	V _{DD} PE		R26	V _{SS}		T26	V _{SS}	
N27	V _{TT} PE		P27	V _{SS}		R27	V _{DD} APE		T27	V _{SS}	
N28	V _{SS}		P28	V _{SS}		R28	V _{SS}		T28	V _{SS}	
N29	V _{SS}		P29	V _{SS}		R29	V _{SS}		T29	V _{SS}	
N30	PE0RN02		P30	V _{SS}		R30	PE0RN01		T30	PE0RN00	
N31	PE0RP02		P31	V _{SS}		R31	PE0RP01		T31	PE0RP00	
N32	V _{SS}		P32	V _{SS}		R32	V _{SS}		T32	V _{SS}	
N33	PE0TN02		P33	V _{SS}		R33	PE0TN01		T33	PE0TN00	
N34	PE0TP02		P34	V _{SS}		R34	PE0TP01		T34	PE0TP00	

Table 18 PES48T12 1156-pin Signal Pin-Out (Part 4 of 9)

Pin	Function	Alt	Pin	Function	Alt	Pin	Function	Alt	Pin	Function	Alt
U1	PE11TP03		V1	V _{SS}		W1	PE4TP00		Y1	PE4TP01	
U2	PE11TN03		V2	V _{SS}		W2	PE4TN00		Y2	PE4TN01	
U3	V _{SS}		V3	V _{SS}		W3	V _{SS}		Y3	V _{SS}	
U4	PE11RP03		V4	V _{SS}		W4	PE4RP00		Y4	PE4RP01	
U5	PE11RN03		V5	V _{SS}		W5	PE4RN00		Y5	PE4RN01	
U6	V _{SS}		V6	V _{SS}		W6	V _{SS}		Y6	V _{SS}	
U7	PEREFCLKN2		V7	PEREFCLKP2		W7	V _{SS}		Y7	V _{SS}	
U8	V _{SS}		V8	V _{SS}		W8	V _{SS}		Y8	V _{DD} APE	
U9	V _{TT} PE		V9	V _{TT} PE		W9	V _{SS}		Y9	V _{SS}	
U10	V _{TT} PE		V10	V _{TT} PE		W10	V _{SS}		Y10	V _{DD} APE	
U11	V _{DD} PE		V11	V _{DD} PE		W11	V _{SS}		Y11	V _{DD} PE	
U12	V _{DD} PE		V12	V _{DD} PE		W12	V _{SS}		Y12	V _{DD} PE	
U13	V _{DD} CORE		V13	V _{SS}		W13	V _{DD} CORE		Y13	V _{DD} CORE	
U14	V _{DD} CORE		V14	V _{SS}		W14	V _{DD} CORE		Y14	V _{SS}	
U15	V _{SS}		V15	V _{DD} CORE		W15	V _{SS}		Y15	V _{DD} CORE	
U16	V _{DD} CORE		V16	V _{SS}		W16	V _{DD} CORE		Y16	V _{SS}	
U17	V _{SS}		V17	V _{DD} CORE		W17	V _{SS}		Y17	V _{DD} CORE	
U18	V _{DD} CORE		V18	V _{SS}		W18	V _{DD} CORE		Y18	V _{SS}	
U19	V _{SS}		V19	V _{DD} CORE		W19	V _{SS}		Y19	V _{DD} CORE	
U20	V _{DD} CORE		V20	V _{SS}		W20	V _{DD} CORE		Y20	V _{SS}	
U21	V _{SS}		V21	V _{DD} CORE		W21	V _{SS}		Y21	V _{DD} CORE	
U22	V _{SS}		V22	V _{DD} CORE		W22	V _{SS}		Y22	V _{DD} CORE	
U23	V _{DD} PE		V23	V _{DD} PE		W23	V _{SS}		Y23	V _{DD} PE	
U24	V _{DD} PE		V24	V _{DD} PE		W24	V _{SS}		Y24	V _{DD} PE	
U25	V _{TT} PE		V25	V _{TT} PE		W25	V _{SS}		Y25	V _{DD} APE	
U26	V _{TT} PE		V26	V _{TT} PE		W26	V _{SS}		Y26	V _{SS}	
U27	V _{SS}		V27	V _{SS}		W27	V _{SS}		Y27	V _{DD} APE	
U28	PEREFCLKP0		V28	PEREFCLKN0		W28	V _{SS}		Y28	V _{SS}	
U29	V _{SS}		V29	V _{SS}		W29	V _{SS}		Y29	V _{SS}	
U30	V _{SS}		V30	NC		W30	NC		Y30	V _{SS}	
U31	V _{SS}		V31	NC		W31	NC		Y31	V _{SS}	
U32	V _{SS}		V32	V _{SS}		W32	V _{SS}		Y32	V _{SS}	
U33	V _{SS}		V33	NC		W33	NC		Y33	V _{SS}	
U34	V _{SS}		V34	NC		W34	NC		Y34	V _{SS}	

Table 18 PES48T12 1156-pin Signal Pin-Out (Part 5 of 9)

Pin	Function	Alt	Pin	Function	Alt	Pin	Function	Alt	Pin	Function	Alt
AA1	V _{SS}		AB1	PE4TP02		AC1	PE4TP03		AD1	V _{SS}	
AA2	V _{SS}		AB2	PE4TN02		AC2	PE4TN03		AD2	V _{SS}	
AA3	V _{SS}		AB3	V _{SS}		AC3	V _{SS}		AD3	V _{SS}	
AA4	V _{SS}		AB4	PE4RP02		AC4	PE4RP03		AD4	V _{SS}	
AA5	V _{SS}		AB5	PE4RN02		AC5	PE4RN03		AD5	V _{SS}	
AA6	V _{SS}		AB6	V _{SS}		AC6	V _{SS}		AD6	V _{SS}	
AA7	V _{SS}		AB7	V _{SS}		AC7	V _{SS}		AD7	V _{SS}	
AA8	V _{SS}		AB8	V _{TT} PE		AC8	V _{SS}		AD8	V _{SS}	
AA9	V _{DD} PE		AB9	V _{SS}		AC9	V _{SS}		AD9	V _{SS}	
AA10	V _{SS}		AB10	V _{TT} PE		AC10	V _{SS}		AD10	V _{SS}	
AA11	V _{DD} PE		AB11	V _{DD} PE		AC11	V _{SS}		AD11	V _{SS}	
AA12	V _{SS}		AB12	V _{DD} PE		AC12	V _{SS}		AD12	V _{SS}	
AA13	V _{DD} CORE		AB13	V _{DD} CORE		AC13	V _{DD} PE		AD13	V _{DD} PE	
AA14	V _{DD} CORE		AB14	V _{DD} CORE		AC14	V _{SS}		AD14	V _{DD} PE	
AA15	V _{SS}		AB15	V _{DD} CORE		AC15	V _{DD} PE		AD15	V _{DD} PE	
AA16	V _{DD} CORE		AB16	V _{DD} CORE		AC16	V _{SS}		AD16	V _{SS}	
AA17	V _{SS}		AB17	V _{SS}		AC17	V _{DD} PE		AD17	V _{DD} PE	
AA18	V _{DD} CORE		AB18	V _{DD} CORE		AC18	V _{DD} PE		AD18	V _{DD} PE	
AA19	V _{SS}		AB19	V _{SS}		AC19	V _{SS}		AD19	V _{SS}	
AA20	V _{DD} CORE		AB20	V _{DD} CORE		AC20	V _{DD} PE		AD20	V _{DD} PE	
AA21	V _{SS}		AB21	V _{DD} CORE		AC21	V _{SS}		AD21	V _{DD} PE	
AA22	V _{DD} CORE		AB22	V _{DD} CORE		AC22	V _{DD} PE		AD22	V _{DD} PE	
AA23	V _{SS}		AB23	V _{DD} PE		AC23	V _{SS}		AD23	V _{SS}	
AA24	V _{DD} PE		AB24	V _{DD} PE		AC24	V _{SS}		AD24	V _{SS}	
AA25	V _{SS}		AB25	V _{TT} PE		AC25	V _{SS}		AD25	V _{SS}	
AA26	V _{DD} PE		AB26	V _{SS}		AC26	V _{SS}		AD26	V _{SS}	
AA27	V _{SS}		AB27	V _{TT} PE		AC27	V _{SS}		AD27	V _{SS}	
AA28	V _{SS}		AB28	V _{SS}		AC28	V _{SS}		AD28	V _{SS}	
AA29	V _{SS}		AB29	V _{SS}		AC29	V _{SS}		AD29	V _{SS}	
AA30	NC		AB30	NC		AC30	V _{SS}		AD30	NC	
AA31	NC		AB31	NC		AC31	V _{SS}		AD31	NC	
AA32	V _{SS}		AB32	V _{SS}		AC32	V _{SS}		AD32	V _{SS}	
AA33	NC		AB33	NC		AC33	V _{SS}		AD33	NC	
AA34	NC		AB34	NC		AC34	V _{SS}		AD34	NC	

Table 18 PES48T12 1156-pin Signal Pin-Out (Part 6 of 9)

Pin	Function	Alt	Pin	Function	Alt	Pin	Function	Alt	Pin	Function	Alt
AE1	PE5TP00		AF1	PE5TP01		AG1	V _{SS}		AH1	PE5TP02	
AE2	PE5TN00		AF2	PE5TN01		AG2	V _{SS}		AH2	PE5TN02	
AE3	V _{SS}		AF3	V _{SS}		AG3	V _{SS}		AH3	V _{SS}	
AE4	PE5RP00		AF4	PE5RP01		AG4	V _{SS}		AH4	PE5RP02	
AE5	PE5RN00		AF5	PE5RN01		AG5	V _{SS}		AH5	PE5RN02	
AE6	V _{SS}		AF6	V _{SS}		AG6	V _{SS}		AH6	V _{SS}	
AE7	V _{SS}		AF7	V _{SS}		AG7	CCLKUS		AH7	V _{SS}	
AE8	V _{SS}		AF8	V _{SS}		AG8	V _{DDIO}		AH8	REFCLKM	
AE9	V _{DDIO}		AF9	V _{DDIO}		AG9	V _{DDIO}		AH9	V _{SS}	
AE10	V _{SS}		AF10	V _{SS}		AG10	V _{SS}		AH10	V _{SS}	
AE11	V _{SS}		AF11	V _{SS}		AG11	V _{SS}		AH11	V _{SS}	
AE12	V _{SS}		AF12	V _{SS}		AG12	V _{SS}		AH12	V _{SS}	
AE13	V _{TTPE}		AF13	V _{SS}		AG13	V _{TTPE}		AH13	V _{SS}	
AE14	V _{SS}		AF14	V _{DDPE}		AG14	V _{SS}		AH14	V _{SS}	
AE15	V _{DDAPE}		AF15	V _{SS}		AG15	V _{DDAPE}		AH15	V _{SS}	
AE16	V _{SS}		AF16	V _{SS}		AG16	V _{SS}		AH16	V _{SS}	
AE17	V _{TTPE}		AF17	V _{TTPE}		AG17	V _{SS}		AH17	PEREFCLKN3	
AE18	V _{TTPE}		AF18	V _{TTPE}		AG18	V _{SS}		AH18	PEREFCLKP3	
AE19	V _{SS}		AF19	V _{SS}		AG19	V _{SS}		AH19	V _{SS}	
AE20	V _{DDAPE}		AF20	V _{SS}		AG20	V _{DDAPE}		AH20	V _{SS}	
AE21	V _{SS}		AF21	V _{DDPE}		AG21	V _{SS}		AH21	V _{SS}	
AE22	V _{TTPE}		AF22	V _{SS}		AG22	V _{TTPE}		AH22	V _{SS}	
AE23	V _{SS}		AF23	V _{SS}		AG23	V _{SS}		AH23	V _{SS}	
AE24	V _{SS}		AF24	V _{SS}		AG24	V _{SS}		AH24	V _{SS}	
AE25	GPIO_06	1	AF25	V _{SS}		AG25	V _{SS}		AH25	V _{SS}	
AE26	V _{DDIO}		AF26	GPIO_09	1	AG26	V _{DDIO}		AH26	V _{SS}	
AE27	V _{SS}		AF27	V _{SS}		AG27	GPIO_04		AH27	V _{SS}	
AE28	V _{SS}		AF28	V _{SS}		AG28	V _{SS}		AH28	V _{SS}	
AE29	V _{SS}		AF29	V _{SS}		AG29	V _{SS}		AH29	V _{SS}	
AE30	NC		AF30	V _{SS}		AG30	NC		AH30	NC	
AE31	NC		AF31	V _{SS}		AG31	NC		AH31	NC	
AE32	V _{SS}		AF32	V _{SS}		AG32	V _{SS}		AH32	V _{SS}	
AE33	NC		AF33	V _{SS}		AG33	NC		AH33	NC	
AE34	NC		AF34	V _{SS}		AG34	NC		AH34	NC	

Table 18 PES48T12 1156-pin Signal Pin-Out (Part 7 of 9)

Pin	Function	Alt	Pin	Function	Alt	Pin	Function	Alt	Pin	Function	Alt
AJ1	PE5TP03		AK1	V _{SS}		AL1	V _{DD} I/O		AM1	P23MERGEN	
AJ2	PE5TN03		AK2	V _{SS}		AL2	P01MERGEN		AM2	P67MERGEN	
AJ3	V _{SS}		AK3	V _{SS}		AL3	P45MERGEN		AM3	V _{SS}	
AJ4	PE5RP03		AK4	V _{SS}		AL4	V _{DD} I/O		AM4	P1011MERGEN	
AJ5	PE5RN03		AK5	V _{SS}		AL5	P89MERGEN		AM5	SWMODE_3	
AJ6	V _{SS}		AK6	V _{SS}		AL6	V _{SS}		AM6	V _{SS}	
AJ7	V _{SS}		AK7	PE6RN00		AL7	PE6RP00		AM7	V _{SS}	
AJ8	V _{SS}		AK8	PE6RN01		AL8	PE6RP01		AM8	V _{SS}	
AJ9	V _{SS}		AK9	V _{SS}		AL9	V _{SS}		AM9	V _{SS}	
AJ10	V _{SS}		AK10	PE6RN02		AL10	PE6RP02		AM10	V _{SS}	
AJ11	V _{SS}		AK11	PE6RN03		AL11	PE6RP03		AM11	V _{SS}	
AJ12	V _{SS}		AK12	V _{SS}		AL12	V _{SS}		AM12	V _{SS}	
AJ13	V _{SS}		AK13	PE7RN00		AL13	PE7RP00		AM13	V _{SS}	
AJ14	V _{SS}		AK14	PE7RN01		AL14	PE7RP01		AM14	V _{SS}	
AJ15	V _{SS}		AK15	V _{SS}		AL15	V _{SS}		AM15	V _{SS}	
AJ16	V _{SS}		AK16	PE7RN02		AL16	PE7RP02		AM16	V _{SS}	
AJ17	V _{SS}		AK17	PE7RN03		AL17	PE7RP03		AM17	V _{SS}	
AJ18	V _{SS}		AK18	V _{SS}		AL18	V _{SS}		AM18	V _{SS}	
AJ19	V _{SS}		AK19	NC		AL19	NC		AM19	V _{SS}	
AJ20	V _{SS}		AK20	NC		AL20	NC		AM20	V _{SS}	
AJ21	V _{SS}		AK21	V _{SS}		AL21	V _{SS}		AM21	V _{SS}	
AJ22	V _{SS}		AK22	NC		AL22	NC		AM22	V _{SS}	
AJ23	V _{SS}		AK23	NC		AL23	NC		AM23	V _{SS}	
AJ24	V _{SS}		AK24	V _{SS}		AL24	V _{SS}		AM24	V _{SS}	
AJ25	V _{SS}		AK25	NC		AL25	NC		AM25	V _{SS}	
AJ26	V _{SS}		AK26	NC		AL26	NC		AM26	V _{SS}	
AJ27	V _{SS}		AK27	V _{SS}		AL27	V _{SS}		AM27	V _{SS}	
AJ28	V _{SS}		AK28	NC		AL28	NC		AM28	V _{SS}	
AJ29	V _{SS}		AK29	NC		AL29	NC		AM29	V _{SS}	
AJ30	V _{SS}		AK30	V _{SS}		AL30	V _{SS}		AM30	V _{SS}	
AJ31	V _{SS}		AK31	GPIO_08	1	AL31	GPIO_07	1	AM31	GPIO_00	
AJ32	V _{SS}		AK32	GPIO_15	1	AL32	V _{DD} I/O		AM32	GPIO_05	1
AJ33	V _{SS}		AK33	GPIO_14	1	AL33	GPIO_10	1	AM33	GPIO_11	1
AJ34	V _{SS}		AK34	V _{DD} I/O		AL34	GPIO_12	1	AM34	GPIO_13	1

Table 18 PES48T12 1156-pin Signal Pin-Out (Part 8 of 9)

Pin	Function	Alt	Pin	Function	Alt	Pin	Function	Alt	Pin	Function	Alt
AN1	V _{SS}		AN18	V _{SS}		AP1	V _{SS}		AP18	V _{SS}	
AN2	V _{DDIO}		AN19	NC		AP2	V _{SS}		AP19	NC	
AN3	V _{SS}		AN20	NC		AP3	RSTHALT		AP20	NC	
AN4	SWMODE_0		AN21	V _{SS}		AP4	SWMODE_1		AP21	V _{SS}	
AN5	SWMODE_2		AN22	NC		AP5	V _{DDIO}		AP22	NC	
AN6	V _{SS}		AN23	NC		AP6	V _{SS}		AP23	NC	
AN7	PE6TN00		AN24	V _{SS}		AP7	PE6TP00		AP24	V _{SS}	
AN8	PE6TN01		AN25	NC		AP8	PE6TP01		AP25	NC	
AN9	V _{SS}		AN26	NC		AP9	V _{SS}		AP26	NC	
AN10	PE6TN02		AN27	V _{SS}		AP10	PE6TP02		AP27	V _{SS}	
AN11	PE6TN03		AN28	NC		AP11	PE6TP03		AP28	NC	
AN12	V _{SS}		AN29	NC		AP12	V _{SS}		AP29	NC	
AN13	PE7TN00		AN30	V _{SS}		AP13	PE7TP00		AP30	V _{SS}	
AN14	PE7TN01		AN31	GPIO_01		AP14	PE7TP01		AP31	V _{DDIO}	
AN15	V _{SS}		AN32	GPIO_02		AP15	V _{SS}		AP32	GPIO_03	
AN16	PE7TN02		AN33	V _{DDIO}		AP16	PE7TP02		AP33	V _{SS}	
AN17	PE7TN03		AN34	V _{SS}		AP17	PE7TP03		AP34	V _{SS}	

Table 18 PES48T12 1156-pin Signal Pin-Out (Part 9 of 9)

Alternate Signal Functions

Pin	GPIO	Alternate	Pin	GPIO	Alternate
AM32	GPIO_05	GPEN	AK32	GPIO_15	P10RSTN
AE25	GPIO_06	P1RSTN	C4	GPIO_16	P11RSTN
AL31	GPIO_07	P2RSTN	C3	GPIO_21	IOEXPINTN0
AK31	GPIO_08	P3RSTN	K10	GPIO_22	IOEXPINTN1
AF26	GPIO_09	P4RSTN	D4	GPIO_23	IOEXPINTN2
AL33	GPIO_10	P5RSTN	E4	GPIO_24	IOEXPINTN3
AM33	GPIO_11	P6RSTN	J9	GPIO_25	IOEXPINTN4
AL34	GPIO_12	P7RSTN	D2	GPIO_26	IOEXPINTN5
AM34	GPIO_13	P8RSTN	E3	GPIO_31	IOEXPINTN10
AK33	GPIO_14	P9RSTN	—	—	—

Table 19 PES48T12 Alternate Signal Functions

Power Pins

V _{DD} Core	V _{DD} Core	V _{DD} IO	V _{DD} PE	V _{DD} PE	V _{DD} APE	V _{TT} PE
N13	V19	A4	J14	V11	H15	H13
N14	V21	A30	J21	V12	H20	H22
N15	V22	B2	L13	V23	K15	J17
N17	W13	B33	L14	V24	K20	J18
N19	W14	D3	L15	Y11	R8	K13
N20	W16	D31	L17	Y12	R10	K17
N21	W18	D34	L18	Y23	R25	K18
N22	W20	E1	L20	Y24	R27	K22
P13	Y13	H9	L21	AA9	Y8	N8
P15	Y15	H27	L22	AA11	Y10	N10
P17	Y17	J26	M13	AA24	Y25	N25
P19	Y19	K9	M15	AA26	Y27	N27
P21	Y21	AE9	M17	AB11	AE15	U9
P22	Y22	AE26	M18	AB12	AE20	U10
R13	AA13	AF9	M20	AB23	AG15	U25
R14	AA14	AG8	M22	AB24	AG20	U26
R16	AA16	AG9	N11	AC13		Y9
R18	AA18	AG26	N12	AC15		V10
R20	AA20	AK34	N23	AC17		V25
R22	AA22	AL1	N24	AC18		V26
T15	AB13	AL4	P9	AC20		AB8
T17	AB14	AL32	P11	AC22		AB10
T19	AB15	AN2	P24	AD13		AB25
T21	AB16	AN33	P26	AD14		AB27
T22	AB18	AP5	R11	AD15		AE13
U13	AB20	AP31	R12	AD17		AE17
U14	AB21		R23	AD18		AE18
U16	AB22		R24	AD20		AE22
U18			U11	AD21		AF17
U20			U12	AD22		AF18
V15			U23	AF14		AG13
V17			U24	AF21		AG22

Table 20 PES48T12 Power Pins

Ground Pins

V _{SS}	V _{SS}	V _{SS}	V _{SS}	V _{SS}	V _{SS}	V _{SS}	V _{SS}
A1	C16	E33	G8	H29	K16	M5	P12
A2	C17	E34	G9	H30	K19	M6	P14
A5	C18	F1	G10	H31	K21	M7	P16
A8	C19	F2	G11	H32	K23	M8	P18
A11	C20	F3	G12	H33	K24	M9	P20
A14	C21	F4	G13	H34	K27	M10	P23
A17	C22	F5	G14	J1	K28	M11	P25
A20	C23	F6	G15	J2	K29	M12	P27
A23	C24	F7	G16	J3	K32	M14	P28
A26	C25	F8	G19	J4	L3	M16	P29
A29	C26	F9	G20	J5	L6	M19	P30
A33	C27	F10	G21	J6	L7	M21	P31
A34	C28	F11	G22	J7	L8	M23	P32
B1	C29	F12	G23	J8	L9	M24	P33
B5	D5	F13	G24	J10	L10	M25	P34
B8	D8	F14	G25	J11	L11	M26	R1
B11	D11	F15	G26	J12	L12	M27	R2
B14	D14	F16	G28	J13	L16	M28	R3
B17	D17	F17	G29	J15	L19	M29	R4
B20	D20	F18	G32	J16	L23	M32	R5
B23	D23	F19	H3	J19	L24	N3	R6
B26	D26	F20	H6	J20	L25	N6	R7
B29	D29	F21	H7	J22	L26	N7	R9
B34	E5	F22	H10	J23	L27	N9	R15
C5	E8	F23	H11	J24	L28	N16	R17
C6	E11	F24	H12	J28	L29	N18	R19
C7	E14	F25	H14	J29	L30	N26	R21
C8	E17	F26	H16	J32	L31	N28	R26
C9	E20	F27	H17	K3	L32	N29	R28
C10	E23	F28	H18	K6	L33	N32	R29
C11	E26	F29	H19	K7	L34	P3	R32
C12	E29	F32	H21	K8	M1	P6	T3
C13	E30	G3	H23	K11	M2	P7	T6
C14	E31	G6	H24	K12	M3	P8	T7
C15	E32	G7	H25	K14	M4	P10	T8

Table 21 PES48T12 Ground Pins (Part 1 of 3)

V _{SS}	V _{SS}	V _{SS}	V _{SS}	V _{SS}	V _{SS}	V _{SS}	V _{SS}
T9	V6	Y18	AB28	AD11	AF15	AH3	AJ19
T10	V8	Y20	AB29	AD12	AF16	AH6	AJ20
T11	V13	Y26	AB32	AD16	AF19	AH7	AJ21
T12	V14	Y28	AC3	AD19	AF20	AH9	AJ22
T13	V16	Y29	AC6	AD23	AF22	AH10	AJ23
T14	V18	Y30	AC7	AD24	AF23	AH11	AJ24
T16	V20	Y31	AC8	AD25	AF24	AH12	AJ25
T18	V27	Y32	AC9	AD26	AF25	AH13	AJ26
T20	V29	Y33	AC10	AD27	AF27	AH14	AJ27
T23	V32	Y34	AC11	AD28	AF28	AH15	AJ28
T24	W3	AA1	AC12	AD29	AF29	AH16	AJ29
T25	W6	AA2	AC14	AD32	AF30	AH19	AJ30
T26	W7	AA3	AC16	AE3	AF31	AH20	AJ31
T27	W8	AA4	AC19	AE6	AF32	AH21	AJ32
T28	W9	AA5	AC21	AE7	AF33	AH22	AJ33
T29	W10	AA6	AC23	AE8	AF34	AH23	AJ34
T32	W11	AA7	AC24	AE10	AG1	AH24	AK1
U3	W12	AA8	AC25	AE11	AG2	AH25	AK2
U6	W15	AA10	AC26	AE12	AG3	AH26	AK3
U8	W17	AA12	AC27	AE14	AG4	AH27	AK4
U15	W19	AA15	AC28	AE16	AG5	AH28	AK5
U17	W21	AA17	AC29	AE19	AG6	AH29	AK6
U19	W22	AA19	AC30	AE21	AG10	AH32	AK9
U21	W23	AA21	AC31	AE23	AG11	AJ3	AK12
U22	W24	AA23	AC32	AE24	AG12	AJ6	AK15
U27	W25	AA25	AC33	AE27	AG14	AJ7	AK18
U29	W26	AA27	AC34	AE28	AG16	AJ8	AK21
U30	W27	AA28	AD1	AE29	AG17	AJ9	AK24
U31	W28	AA29	AD2	AE32	AG18	AJ10	AK27
U32	W29	AA32	AD3	AF3	AG19	AJ11	AK30
U33	W32	AB3	AD4	AF6	AG21	AJ12	AL6
U34	Y3	AB6	AD5	AF7	AG23	AJ13	AL9
V1	Y6	AB7	AD6	AF8	AG24	AJ14	AL12
V2	Y7	AB9	AD7	AF10	AG25	AJ15	AL15
V3	Y9	AB17	AD8	AF11	AG28	AJ16	AL18
V4	Y14	AB19	AD9	AF12	AG29	AJ17	AL21
V5	Y16	AB26	AD10	AF13	AG32	AJ18	AL24

Table 21 PES48T12 Ground Pins (Part 2 of 3)

V _{SS}	V _{SS}	V _{SS}	V _{SS}	V _{SS}	V _{SS}	V _{SS}	V _{SS}
AL27	AM10	AM17	AM24	AN1	AN21	AP6	AP27
AL30	AM11	AM18	AM25	AN3	AN24	AP9	AP30
AM3	AM12	AM19	AM26	AN6	AN27	AP12	AP33
AM6	AM13	AM20	AM27	AN9	AN30	AP15	AP34
AM7	AM14	AM21	AM28	AN12	AN34	AP18	
AM8	AM15	AM22	AM29	AN15	AP1	AP21	
AM9	AM16	AM23	AM30	AN18	AP2	AP24	

Table 21 PES48T12 Ground Pins (Part 3 of 3)

No Connect Pins

NC	NC	NC	NC	NC	NC	NC	NC
V30	AA31	AD33	AG34	AK25	AL26	AN28	AP29
V31	AA33	AD34	AH30	AK26	AL28	AN29	
V33	AA34	AE30	AH31	AK28	AL29	AP19	
V34	AB30	AE31	AH33	AK29	AN19	AP20	
W30	AB31	AE33	AH34	AL19	AN20	AP22	
W31	AB33	AE34	AK19	AL20	AN22	AP23	
W33	AB34	AG30	AK20	AL22	AN23	AP25	
W34	AD30	AG31	AK22	AL23	AN25	AP26	
AA30	AD31	AG33	AK23	AL25	AN26	AP28	

Table 22 PES48T12 No Connect Pins

Signals Listed Alphabetically

Signal Name	I/O Type	Location	Signal Category
CCLKDS	I	K25	System
CCLKUS	I	AG7	

Table 23 89PES48T12 Alphabetical Signal List (Part 1 of 9)

Signal Name	I/O Type	Location	Signal Category
GPIO_00	I/O	AM31	General Purpose I/O
GPIO_01	I/O	AN31	
GPIO_02	I/O	AN32	
GPIO_03	I/O	AP32	
GPIO_04	I/O	AG27	
GPIO_05	I/O	AM32	
GPIO_06	I/O	AE25	
GPIO_07	I/O	AL31	
GPIO_08	I/O	AK31	General Purpose I/O (cont.)
GPIO_09	I/O	AF26	
GPIO_10	I/O	AL33	
GPIO_11	I/O	AM33	
GPIO_12	I/O	AL34	
GPIO_13	I/O	AM34	
GPIO_14	I/O	AK33	
GPIO_15	I/O	AK32	
GPIO_16	I/O	C4	
GPIO_17	I/O	B4	
GPIO_18	I/O	B3	
GPIO_19	I/O	A3	
GPIO_20	I/O	H8	
GPIO_21	I/O	C3	
GPIO_22	I/O	K10	
GPIO_23	I/O	D4	
GPIO_24	I/O	E4	
GPIO_25	I/O	J9	
GPIO_26	I/O	D2	
GPIO_27	I/O	C2	
GPIO_28	I/O	D1	
GPIO_29	I/O	C1	
GPIO_30	I/O	E2	
GPIO_31	I/O	E3	

Table 23 89PES48T12 Alphabetical Signal List (Part 2 of 9)

Signal Name	I/O Type	Location	Signal Category
JTAG_TCK	I	K26	Test
JTAG_TDI	I	C31	
JTAG_TDO	O	J25	
JTAG_TMS	I	D30	
JTAG_TRST_N	I	C32	
MSMBADDR_1	I	A31	SMBus Interface
MSMBADDR_2	I	B31	
MSMBADDR_3	I	B30	
MSMBADDR_4	I	C30	
MSMBCLK	I/O	G27	
MSMBDAT	I/O	H26	
MSMBSMODE	I	A32	System
NC	See Table 22 for a listing of no connect pins.		
P01MERGEN	I	AL2	System
P23MERGEN	I	AM1	
P45MERGEN	I	AL3	
P67MERGEN	I	AM2	
P89MERGEN	I	AL5	
P1011MERGEN	I	AM4	
PE0RN00	I	T30	PCI Express Interface
PE0RN01	I	R30	
PE0RN02	I	N30	
PE0RN03	I	M30	
PE0RP00	I	T31	
PE0RP01	I	R31	
PE0RP02	I	N31	
PE0RP03	I	M31	
PE0TN00	O	T33	
PE0TN01	O	R33	
PE0TN02	O	N33	
PE0TN03	O	M33	
PE0TP00	O	T34	
PE0TP01	O	R34	
PE0TP02	O	N34	
PE0TP03	O	M34	
PE1RN00	I	K30	

Table 23 89PES48T12 Alphabetical Signal List (Part 3 of 9)

Signal Name	I/O Type	Location	Signal Category
PE1RN01	I	J30	PCI Express Interface (cont.)
PE1RN02	I	G30	
PE1RN03	I	F30	
PE1RP00	I	K31	
PE1RP01	I	J31	
PE1RP02	I	G31	
PE1RP03	I	F31	
PE1TN00	O	K33	
PE1TN01	O	J33	
PE1TN02	O	G33	
PE1TN03	O	F33	
PE1TP00	O	K34	
PE1TP01	O	J34	
PE1TP02	O	G34	
PE1TP03	O	F34	
PE2RN00	I	E28	
PE2RN01	I	E27	
PE2RN02	I	E25	
PE2RN03	I	E24	
PE2RP00	I	D28	
PE2RP01	I	D27	
PE2RP02	I	D25	
PE2RP03	I	D24	
PE2TN00	O	B28	
PE2TN01	O	B27	
PE2TN02	O	B25	
PE2TN03	O	B24	
PE2TP00	O	A28	
PE2TP01	O	A27	
PE2TP02	O	A25	
PE2TP03	O	A24	
PE3RN00	I	E22	
PE3RN01	I	E21	
PE3RN02	I	E19	
PE3RN03	I	E18	
PE3RP00	I	D22	

Table 23 89PES48T12 Alphabetical Signal List (Part 4 of 9)

Signal Name	I/O Type	Location	Signal Category
PE3RP01	I	D21	PCI Express Interface (cont.)
PE3RP02	I	D19	
PE3RP03	I	D18	
PE3TN00	O	B22	
PE3TN01	O	B21	
PE3TN02	O	B19	
PE3TN03	O	B18	
PE3TP00	O	A22	
PE3TP01	O	A21	
PE3TP02	O	A19	
PE3TP03	O	A18	
PE4RN00	I	W5	
PE4RN01	I	Y5	
PE4RN02	I	AB5	
PE4RN03	I	AC5	
PE4RP00	I	W4	
PE4RP01	I	Y4	
PE4RP02	I	AB4	
PE4RP03	I	AC4	
PE4TN00	O	W2	
PE4TN01	O	Y2	
PE4TN02	O	AB2	
PE4TN03	O	AC2	
PE4TP00	O	W1	
PE4TP01	O	Y1	
PE4TP02	O	AB1	
PE4TP03	O	AC1	
PE5RN00	I	AE5	
PE5RN01	I	AF5	
PE5RN02	I	AH5	
PE5RN03	I	AJ5	
PE5RP00	I	AE4	
PE5RP01	I	AF4	
PE5RP02	I	AH4	
PE5RP03	I	AJ4	
PE5TN00	O	AE2	

Table 23 89PES48T12 Alphabetical Signal List (Part 5 of 9)

Signal Name	I/O Type	Location	Signal Category
PE5TN01	O	AF2	PCI Express Interface (cont.)
PE5TN02	O	AH2	
PE5TN03	O	AJ2	
PE5TP00	O	AE1	
PE5TP01	O	AF1	
PE5TP02	O	AH1	
PE5TP03	O	AJ1	
PE6RN00	I	AK7	
PE6RN01	I	AK8	
PE6RN02	I	AK10	
PE6RN03	I	AK11	
PE6RP00	I	AL7	
PE6RP01	I	AL8	
PE6RP02	I	AL10	
PE6RP03	I	AL11	
PE6TN00	O	AN7	
PE6TN01	O	AN8	
PE6TN02	O	AN10	
PE6TN03	O	AN11	
PE6TP00	O	AP7	
PE6TP01	O	AP8	
PE6TP02	O	AP10	
PE6TP03	O	AP11	
PE7RN00	I	AK13	
PE7RN01	I	AK14	
PE7RN02	I	AK16	
PE7RN03	I	AK17	
PE7RP00	I	AL13	
PE7RP01	I	AL14	
PE7RP02	I	AL16	
PE7RP03	I	AL17	
PE7TN00	O	AN13	
PE7TN01	O	AN14	
PE7TN02	O	AN16	
PE7TN03	O	AN17	
PE7TP00	O	AP13	

Table 23 89PES48T12 Alphabetical Signal List (Part 6 of 9)

Signal Name	I/O Type	Location	Signal Category
PE7TP01	O	AP14	PCI Express Interface (cont.)
PE7TP02	O	AP16	
PE7TP03	O	AP17	
PE8RN00	I	E16	
PE8RN01	I	E15	
PE8RN02	I	E13	
PE8RN03	I	E12	
PE8RP00	I	D16	
PE8RP01	I	D15	
PE8RP02	I	D13	
PE8RP03	I	D12	
PE8TN00	O	B16	
PE8TN01	O	B15	
PE8TN02	O	B13	
PE8TN03	O	B12	
PE8TP00	O	A16	
PE8TP01	O	A15	
PE8TP02	O	A13	
PE8TP03	O	A12	
PE9RN00	I	E10	
PE9RN01	I	E9	
PE9RN02	I	E7	
PE9RN03	I	E6	
PE9RP00	I	D10	
PE9RP01	I	D9	
PE9RP02	I	D7	
PE9RP03	I	D6	
PE9TN00	O	B10	
PE9TN01	O	B9	
PE9TN02	O	B7	
PE9TN03	O	B6	
PE9TP00	O	A10	
PE9TP01	O	A9	
PE9TP02	O	A7	
PE9TP03	O	A6	
PE10RN00	I	G5	

Table 23 89PES48T12 Alphabetical Signal List (Part 7 of 9)

Signal Name	I/O Type	Location	Signal Category
PE10RN01	I	H5	PCI Express Interface (cont.)
PE10RN02	I	K5	
PE10RN03	I	L5	
PE10RP00	I	G4	
PE10RP01	I	H4	
PE10RP02	I	K4	
PE10RP03	I	L4	
PE10TN00	O	G2	
PE10TN01	O	H2	
PE10TN02	O	K2	
PE10TN03	O	L2	
PE10TP00	O	G1	
PE10TP01	O	H1	
PE10TP02	O	K1	
PE10TP03	O	L1	
PE11RN00	I	N5	
PE11RN01	I	P5	
PE11RN02	I	T5	
PE11RN03	I	U5	
PE11RP00	I	N4	
PE11RP01	I	P4	
PE11RP02	I	T4	
PE11RP03	I	U4	
PE11TN00	O	N2	
PE11TN01	O	P2	
PE11TN02	O	T2	
PE11TN03	O	U2	
PE11TP00	O	N1	
PE11TP01	O	P1	
PE11TP02	O	T1	
PE11TP03	O	U1	
PEREFCLKN0	I	V28	
PEREFCLKN1	I	G18	
PEREFCLKN2	I	U7	
PEREFCLKN3	I	AH17	
PEREFCLKP0	I	U28	

Table 23 89PES48T12 Alphabetical Signal List (Part 8 of 9)

Signal Name	I/O Type	Location	Signal Category
PEREFCLKP1	I	G17	PCI Express Interface (cont.)
PEREFCLKP2	I	V7	
PEREFCLKP3	I	AH18	
PERSTN	I	B32	System
REFCLKM	I	AH8	PCI Express Interface
RSTHALT	I	AP3	System
SSMBADDR_1	I	C34	SMBus Interface
SSMBADDR_2	I	C33	
SSMBADDR_3	I	D33	
SSMBADDR_5	I	D32	
SSMBCLK	I/O	H28	
SSMBDAT	I/O	J27	
SWMODE_0	I	AN4	
SWMODE_1	I	AP4	
SWMODE_2	I	AN5	
SWMODE_3	I	AM5	
V _{DD} CORE, V _{DD} APE, V _{DD} IO, V _{DD} PE, V _{TT} PE	See Table 20 for a listing of power pins.		
V _{SS}	See Table 21 for a listing of ground pins.		

Table 23 89PES48T12 Alphabetical Signal List (Part 9 of 9)

REVISIONS			
REV	DESCRIPTION	DATE	APPROVED
00	INITIAL RELEASE	05/31/06	TV

NOTES:

- 1 ALL DIMENSIONING AND TOLERANCING CONFORM TO ANSI Y14.5M-1982
- 2 "e" REPRESENTS THE BASIC SOLDER BALL GRID PITCH
- 3 "M" REPRESENTS THE MAXIMUM SOLDER BALL MATRIX SIZE
- 4 "N" REPRESENTS THE BALLCOUNT NUMBER

△ DIMENSION "X" IS MEASURED AT THE MINIMUM SOLDER BALL DIAMETER, PARALLEL TO PRIMARY DATUM C-C

△ SEATING PLANE AND PRIMARY DATUM C-C ARE DEFINED BY THE SPHERICAL CROWNS OF THE SOLDER BALLS

△ "X" ID CORNER MUST BE IDENTIFIED BY CHAMFER, INK MARK, METALLIZED MARKING, INDEENTATION OR OTHER FEATURE ON PACKAGE BODY

△ EXACT SHAPE OF EACH CORNER IS OPTIONAL

9 ALL DIMENSIONS ARE IN MILLIMETERS

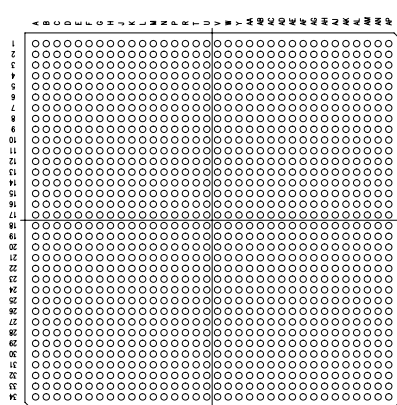

1156 BALLS

SYMBOL	JEDEC VARIATION			NOTES
	MIN	NOM	MAX	
A	—	—	3.42	
A1	.30	—	—	
A2	2.16	—	2.82	
D	35.00 BSC			
E	35.00 BSC			
M	34			3
N	1156			4
e	1.00 BSC			
b	.50	.60	.70	5
CENTER BALL MATRIX	N/A			

TOLERANCES UNLESS SPECIFIED DECIMAL ANGULAR XX± .05 ±1° XXX± .030	 6024 Silver Creek Valley Rd San Jose, CA 95138 PHONE: (408) 284-8200 FAX: (408) 284-3572 www.IDT.com	TITLE BL/BR PACKAGE OUTLINE 35.0 x 35.0 mm BODY 1.00 mm PITCH FCBCA
APPROVALS DATE 05/31/06	DRAWN BY	
CHECKED	SIZE C	
	DRAWING No. PSC-4190	
	REV 00	
	DO NOT SCALE DRAWING	
	SHEET 2 OF 2	

Revision History

July 19, 2007: Initial publication of data sheet.

Ordering Information

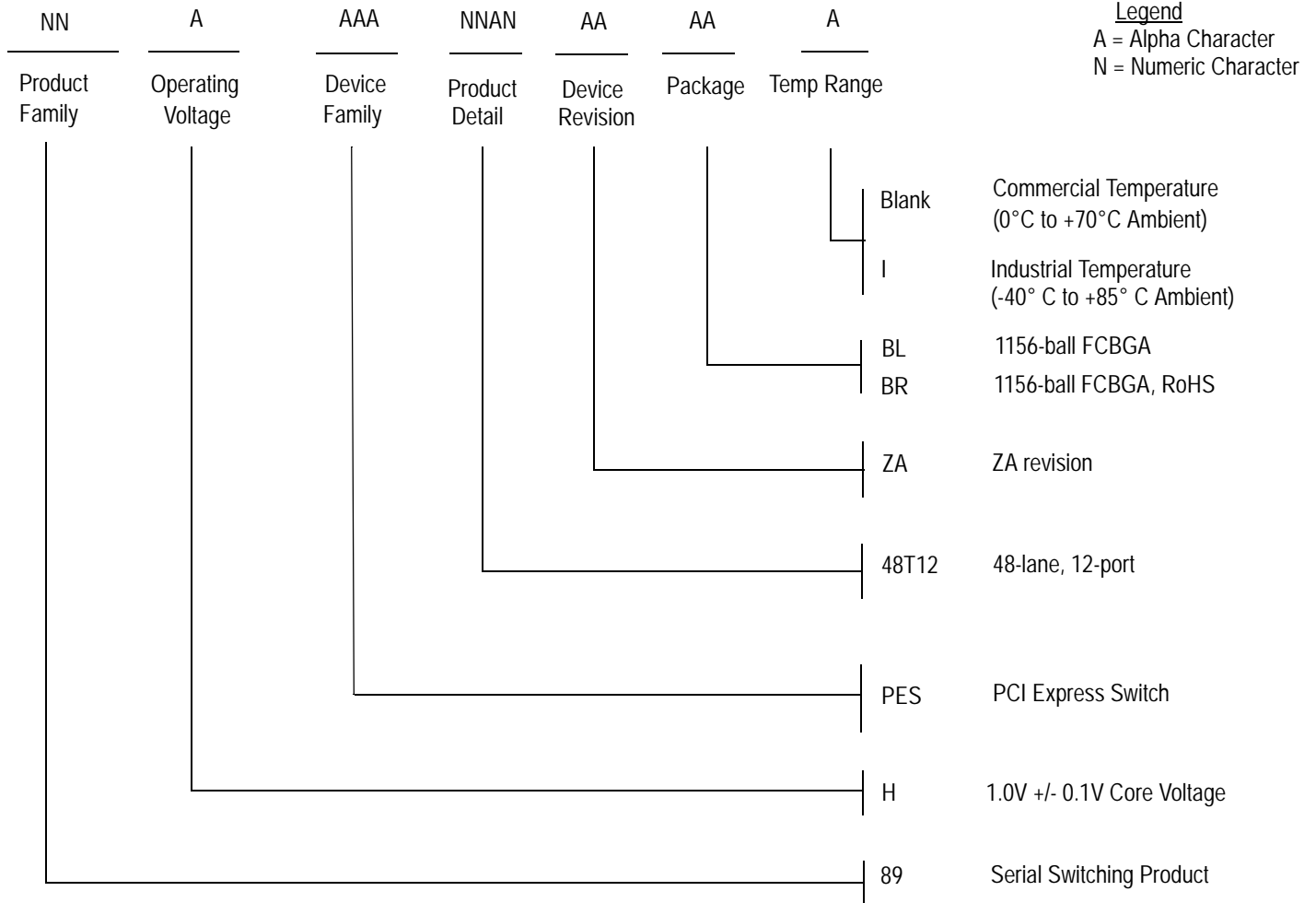

Valid Combinations

- 89HPES48T12ZABL 1156-ball FCBGA package, Commercial Temperature
- 89HPES48T12ZABR 1156-ball RoHS FCBGA package, Commercial Temperature
- 89HPES48T12ZABLI 1156-ball FCBGA package, Industrial Temperature
- 89HPES48T12ZABRI 1156-ball RoHS FCBGA package, Industrial Temperature



CORPORATE HEADQUARTERS
 6024 Silver Creek Valley Road
 San Jose, CA 95138

for SALES:
 800-345-7015 or 408-284-8200
 fax: 408-284-2775
www.idt.com

for Tech Support:
 email: ssdhelp@idt.com
 phone: 408-284-8208