

Thin-Film Directional Couplers



CP0603 SMD Type

GENERAL DESCRIPTION ITF (Integrated Thin-Film) TECHNOLOGY

The ITF SMD Coupler is based on thin-film multilayer technology. The technology provides a miniature part with excellent high frequency performance and rugged construction for reliable automatic assembly. The ITF Coupler is offered in a variety of frequency bands compatible with various types of high frequency wireless systems.

DIMENSIONS: millimeters (inches)

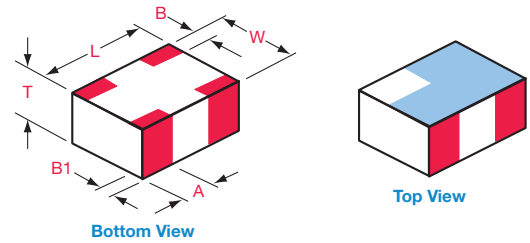

	0603
L	1.6±0.1 (0.063±0.004)
W	0.84±0.1 (0.033±0.004)
T	0.60±0.1 (0.028±0.004)
A	0.35±0.15 (0.014±0.006)
B	0.175±0.1 (0.007±0.004)
B1	0.00+0.1/0-0.0 (0.00+0.004/-0.0)

APPLICATIONS

- Mobile Communications
- Satellite TV Receivers
- GPS
- Vehicle Location Systems
- Wireless LAN's

FEATURES

- Miniature Size: 0603
- Frequency Range: 800MHz - 3GHz
- Characteristic Impedance: 50Ω
- Operating / Storage Temp.: -40°C to +85°C
- Power Rating: 3W Continuous
- Low Profile
- Rugged Construction
- Taped and Reeled

3

HOW TO ORDER

CP Style Directional Coupler	0603 Size 0603	X Type	**** Frequency MHz	X Sub Type	S Termination Code W = Sn90, Pb10 **S = Sn100	TR Packaging Code TR = Tape and Reel
--	--	-----------------------------	--	---------------------------------	--	--

****RoHS compliant**

QUALITY INSPECTION

Finished parts are 100% tested for electrical parameters and visual characteristics. Each production lot is evaluated on a sample basis for:

- Static Humidity: 85°C, 85% RH, 160 hours
- Endurance: 125°C, I_R, 4 hours

TERMINATION

Nickel/Solder coating compatible with automatic soldering technologies: reflow, wave soldering, vapor phase and manual.

Recommended Pad Layout Dimensions mm (inches)

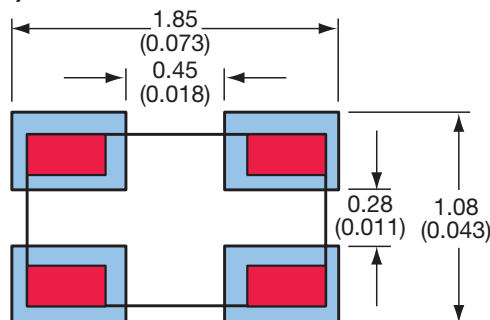

TERMINALS (Top View)

Not RoHS Compliant

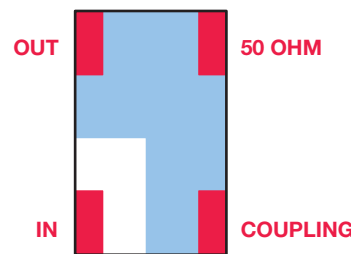

For RoHS compliant products, please select correct termination style.

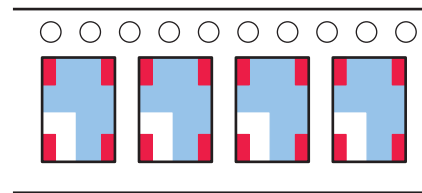

Orientation in tape

Thin-Film Directional Couplers



CP0603 SMD Type

Coupler P/N CP0603A****AW

Application	P/N Examples	Frequency Band [MHz]	Coupling [dB]	I. Loss max	VSWR max
AMPS	CP0603A0836AW	824 - 849	18.5±1	0.25	1.2
	CP0603A0881AW	869 - 894	18.5±1		
GSM	CP0603A0902AW	890 - 915	18±1	0.25	
	CP0603A0947AW	935 - 960	17.5±1		
E-GSM	CP0603A0897AW	880 - 915	18±1	0.25	
	CP0603A0942AW	925 - 960	17.5±1		
PDC	CP0603A1441AW	1429 - 1453	14±1	0.4	
PCN	CP0603A1747AW	1710 - 1785	12.5±1	0.6	
	CP0603A1842AW	1805 - 1880	12±1		
PCS	CP0603A1880AW	1850 - 1910	12±1	0.65	
	CP0603A1960AW	1930 - 1990	11.5±1		
PHP	CP0603A1907AW	1895 - 1920	12±1	0.6	
DECT	CP0603A1890AW	1880 - 1900	12±1	0.6	
Wireless LAN	CP0603A2442AW	2400 - 2484	10±1	0.85	

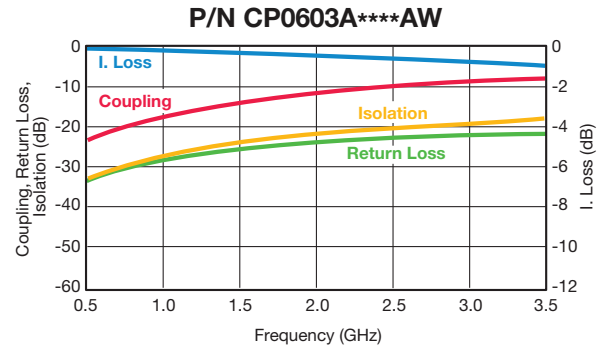

Coupler P/N CP0603A****BW

Application	P/N Examples	Frequency Band [MHz]	Coupling [dB]	I. Loss max	VSWR max
AMPS	CP0603A0836BW	824 - 849	16±1	0.25	1.2
	CP0603A0881BW	869 - 894	15.5±1		
GSM	CP0603A0902BW	890 - 915	15.5±1	0.25	
	CP0603A0947BW	935 - 960	15±1		
E-GSM	CP0603A0897BW	880 - 915	15.5±1	0.55	
	CP0603A0942BW	925 - 960	15±1		
PDC	CP0603A1441BW	1429 - 1453	11.5±1	0.55	
PCN	CP0603A1747BW	1710 - 1785	10±1	0.8	
	CP0603A1842BW	1805 - 1880	9.5±1		
PCS	CP0603A1880BW	1850 - 1910	9±1	0.8	
	CP0603A1960BW	1930 - 1990	9±1		
PHP	CP0603A1907BW	1895 - 1920	9±1	0.8	
DECT	CP0603A1890BW	1880 - 1900	9±1	0.8	
Wireless LAN	CP0603A2442BW	2400 - 2484	7.5±1	1.1	

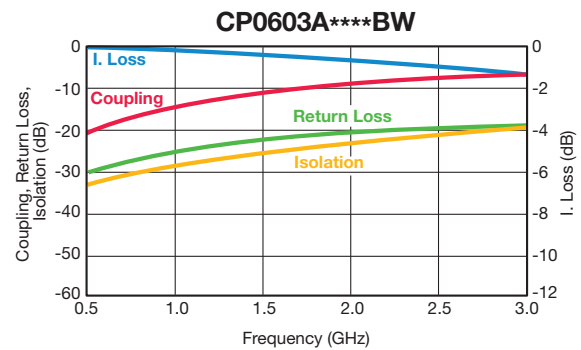

Coupler P/N CP0603A****CW

Application	P/N Examples	Frequency Band [MHz]	Coupling [dB]	I. Loss max	VSWR max
AMPS	CP0603A0836CW	824 - 849	21±1	0.25	1.2
	CP0603A0881CW	869 - 894	20.5±1		
GSM	CP0603A0902CW	890 - 915	20.5±1	0.25	
	CP0603A0947CW	935 - 960	20±1		
E-GSM	CP0603A0897CW	880 - 915	20.5±1	0.25	
	CP0603A0942CW	925 - 960	20±1		
PDC	CP0603A1441CW	1429 - 1453	16.5±1	0.40	
PCN	CP0603A1747CW	1710 - 1785	15±1	0.5	
	CP0603A1842CW	1805 - 1880	14.5±1		
PCS	CP0603A1880CW	1850 - 1910	14.5±1	0.5	
	CP0603A1960CW	1930 - 1990	14±1		
PHP	CP0603A1907CW	1895 - 1920	14.5±1	0.5	
DECT	CP0603A1890CW	1880 - 1900	14.5±1	0.5	
Wireless LAN	CP0603A2442CW	2400 - 2484	12.5±1	0.65	

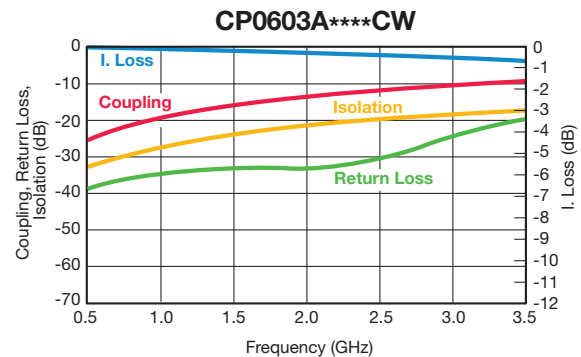

Coupler P/N CP0603A****DW

Application	P/N Examples	Frequency Band [MHz]	Coupling [dB]	I. Loss max	VSWR max
AMPS	CP0603A0836DW	824 - 849	15.0±1	0.40	1.2
	CP0603A0881DW	869 - 894	14.5±1		
GSM	CP0603A0902DW	890 - 915	14.5±1	0.40	
	CP0603A0947DW	935 - 960	14±1		
E-GSM	CP0603A0897DW	880 - 915	14.5±1	0.40	
	CP0603A0942DW	925 - 960	14±1		
PDC	CP0603A1441DW	1429 - 1453	10.5±1	0.7	
PCN	CP0603A1747DW	1710 - 1785	9±1	0.9	
	CP0603A1842DW	1805 - 1880	8.5±1		
PCS	CP0603A1880DW	1850 - 1910	8.5±1	1.0	
	CP0603A1960DW	1930 - 1990	8±1		
PHP	CP0603A1907DW	1895 - 1920	8.5±1	1.0	
DECT	CP0603A1890DW	1880 - 1900	8.5±1	1.0	
Wireless LAN	CP0603A2442DW	2400 - 2484	6.5±1	1.5	

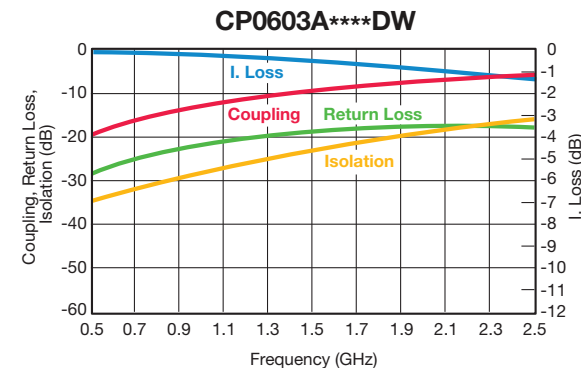

Important: Couplers can be used at any frequency within the indicated range.



Thin-Film Directional Couplers



CP0603 SMD Type

Coupler P/N CP0603B****AW

Application	P/N Examples	Frequency Band [MHz]	Coupling [dB]	I. Loss max	VSWR max	
AMPS	CP0603B0836AW	824 - 849	24.5±1	0.2	1.2	
	CP0603B0881AW	869 - 894	24±1			
GSM	CP0603B0902AW	890 - 915	24±1			
	CP0603B0947AW	935 - 960	23.5±1			
E-GSM	CP0603B0897AW	880 - 915	24±1			0.25
	CP0603B0942AW	925 - 960	23.5±1			
PDC	CP0603B1441AW	1429 - 1453	20±1	0.3		
PCN	CP0603B1747AW	1710 - 1785	18±1			
	CP0603B1842AW	1805 - 1880	17.5±1			
PCS	CP0603B1880AW	1850 - 1910	17.5±1	0.3		
	CP0603B1960AW	1930 - 1990	17.5±1			
PHP	CP0603B1907AW	1895 - 1920	17.5±1	0.45		
DECT	CP0603B1890AW	1880 - 1900	17.5±1			
Wireless LAN	CP0603B2442AW	2400 - 2484	15.5±1			

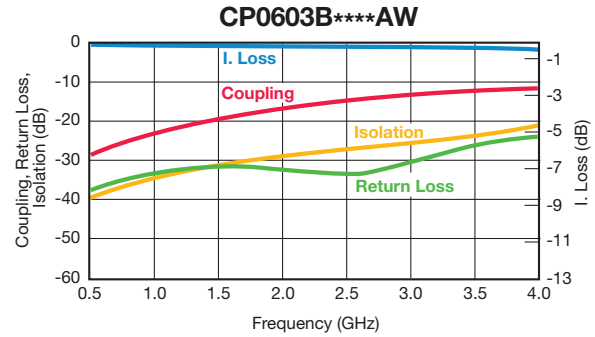

Coupler P/N CP0603B****BW

Application	P/N Examples	Frequency Band [MHz]	Coupling [dB]	I. Loss max	VSWR max	
AMPS	CP0603B0836BW	824 - 849	25.5±1	0.2	1.2	
	CP0603B0881BW	869 - 894	25±1			
GSM	CP0603B0902BW	890 - 915	25±1			
	CP0603B0947BW	935 - 960	24.5±1			
E-GSM	CP0603B0897BW	880 - 915	25±1			0.25
	CP0603B0942BW	925 - 960	24.5±1			
PDC	CP0603B1441BW	1429 - 1453	21±1	0.25		
PCN	CP0603B1747BW	1710 - 1785	19±1			
	CP0603B1842BW	1805 - 1880	19±1			
PCS	CP0603B1880BW	1850 - 1910	18.5±1	0.35		
	CP0603B1960BW	1930 - 1990	18.5±1			
PHP	CP0603B1907BW	1895 - 1920	18.5±1	0.35		
DECT	CP0603B1890BW	1880 - 1900	18.5±1			
Wireless LAN	CP0603B2442BW	2400 - 2484	16.5±1			

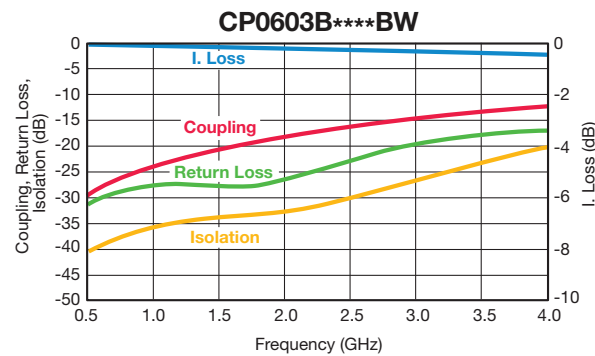

Coupler P/N CP0603B****CW

Application	P/N Examples	Frequency Band [MHz]	Coupling [dB]	I. Loss max	VSWR max	
AMPS	CP0603B0836CW	824 - 849	26.5±1	0.2	1.2	
	CP0603B0881CW	869 - 894	26±1			
GSM	CP0603B0902CW	890 - 915	26±1			
	CP0603B0947CW	935 - 960	25.5±1			
E-GSM	CP0603B0897CW	880 - 915	26±1			0.25
	CP0603B0942CW	925 - 960	25.5±1			
PDC	CP0603B1441CW	1429 - 1453	22±1	0.25		
PCN	CP0603B1747CW	1710 - 1785	20.5±1			
	CP0603B1842CW	1805 - 1880	20±1			
PCS	CP0603B1880CW	1850 - 1910	20±1	0.35		
	CP0603B1960CW	1930 - 1990	19.5±1			
PHP	CP0603B1907CW	1895 - 1920	20±1	0.35		
DECT	CP0603B1890CW	1880 - 1900	20±1			
Wireless LAN	CP0603B2442CW	2400 - 2484	18±1			

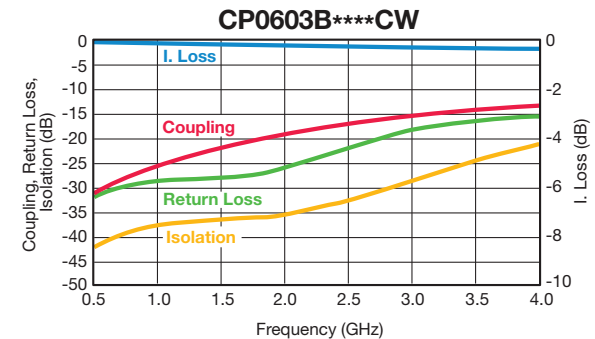

Important: Couplers can be used at any frequency within the indicated range.

Thin-Film Directional Couplers



CP0603 SMD Type – High Directivity

Coupler P/N CP0603D****AW

Application	P/N Examples	Frequency Band [MHz]	Coupling [dB]	I. Loss max. [dB]	Return Loss [dB]	Directivity [dB]
AMPS	CP0603D0836AW	824 - 849	13.50	0.50	23	21
	CP0603D0881AW	869 - 894	13.00			
GSM	CP0603D0902AW	890 - 915	12.50	1.40	16	17
	CP0603D0947AW	935 - 960	13.00			
E-GSM	CP0603D0897AW	880 - 915	12.50	2.00	15	15
	CP0603D0942AW	925 - 960	12.50			
PDC	CP0603D1441AW	1429 - 1453	9.00	1.00	18	19
PCN	CP0603D1747AW	1710 - 1785	8.00	1.40	17	18
	CP0603D1842AW	1805 - 1880	7.50			
PCS	CP0603D1880AW	1850 - 1910	7.00	1.40	16	17
	CP0603D1960AW	1930 - 1990	7.00			
PHP	CP0603D1907AW	1895 - 1920	7.00	1.40	16	17
DECT	CP0603D1890AW	1880 - 1900	7.00	1.40	16	17
Wireless LAN	CP0603D2442AW	2400 - 2484	5.50	2.00	15	15

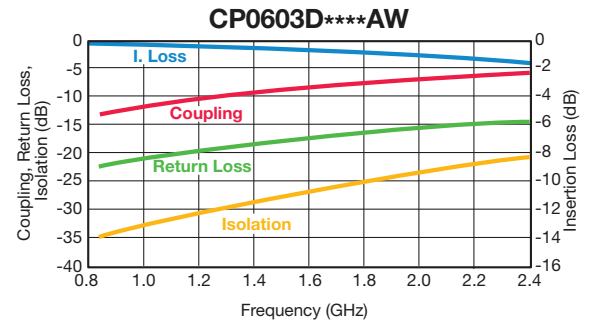

Coupler P/N CP0603D****BW

Application	P/N Examples	Frequency Band [MHz]	Coupling [dB]	I. Loss max. [dB]	Return Loss [dB]	Directivity [dB]
AMPS	CP0603D0836BW	824 - 849	20.00	0.25	36	19
	CP0603D0881BW	869 - 894	19.50			
GSM	CP0603D0902BW	890 - 915	19.00	0.55	27	27
	CP0603D0947BW	935 - 960	19.00			
E-GSM	CP0603D0897BW	880 - 915	19.50	0.70	24	24
	CP0603D0942BW	925 - 960	19.00			
PDC	CP0603D1441BW	1429 - 1453	15.50	0.40	30	30
PCN	CP0603D1747BW	1710 - 1785	14.00	0.55	27	27
	CP0603D1842BW	1805 - 1880	13.50			
PCS	CP0603D1880BW	1850 - 1910	13.00	0.55	27	27
	CP0603D1960BW	1930 - 1990	13.00			
PHP	CP0603D1907BW	1895 - 1920	13.00	0.55	27	27
DECT	CP0603D1890BW	1880 - 1900	13.00	0.55	27	27
Wireless LAN	CP0603D2442BW	2400 - 2484	11.00	0.70	24	24

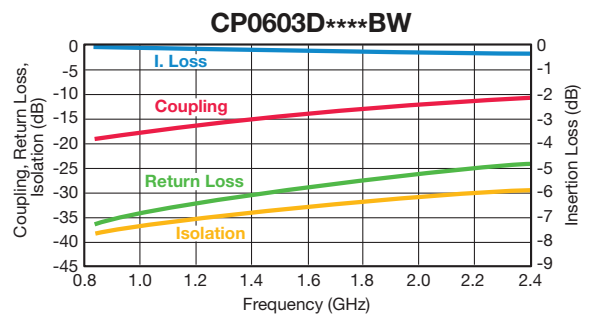

3

Important: Couplers can be used at any frequency within the indicated range.



Thin-Film Directional Couplers



CP0805 and CP0603 Test Jig

ITF TEST JIG FOR COUPLER TYPES 0805 AND 0603 SMD

GENERAL DESCRIPTION

This jig is designed for the testing of CP0805 and CP0603 series Directional Couplers using a vector network analyzer. It consists of a FR4 multi-layer substrate, having 50Ω microstrips as conducting lines and a ground plane in the middle layer, located at a distance of 0.2mm from the microstrips.

The connectors are SMA type (female), 'Johnson Components Inc.' Product P/N: 142-0701-881.

The jig is designed for a full 2-port calibration. LOAD calibration can be done either by a 50Ω SMA termination, or by soldering a 50Ω chip resistor at the 50Ω ports.

MEASUREMENT PROCEDURE

When measuring a component, it can be either soldered or pressed by a non-metallic stick until all four ports touch the appropriate pads. To measure the coupling (and the R. Loss) place the component on the Port 1 & Port 2 pads. Use two SMA 50Ω terminations (male) to terminate the ports, which are not connected to the network analyzer, and connect the network analyzer to the two ports. A 90° rotation of the component on its pads allows measuring a second parameter (I. Loss).

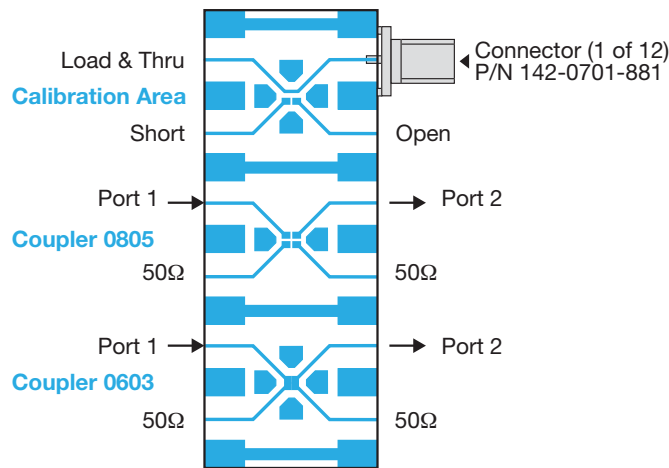

CP0805 SERIES DIRECTIONAL COUPLERS

Orientation and Tape and Reel Packaging Specification

(Top View)

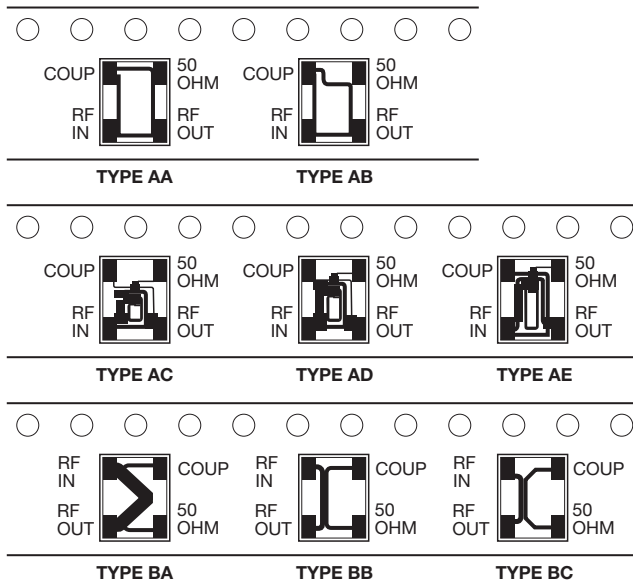

The parts should be mounted on the PCB with White (Alumina) side down and the "dark" side up.

CP0805xxxxxSTR (Sn100)

(Top View)

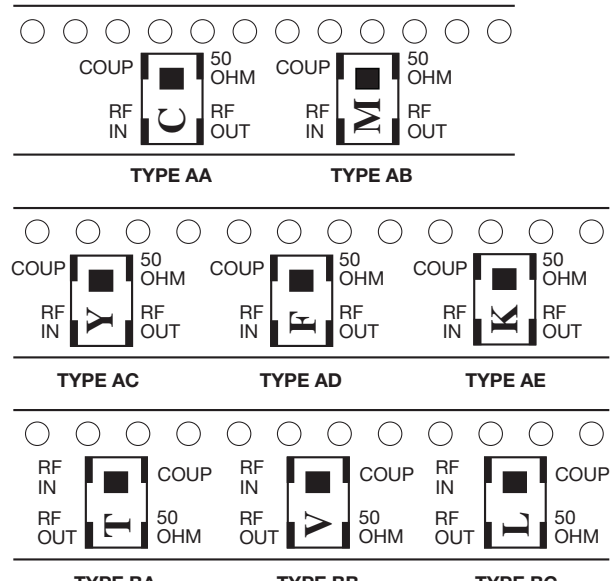

The parts should be mounted on the PCB with printed side up.