

MAC12SM, MAC12SN

Preferred Device

Sensitive Gate Triacs

Silicon Bidirectional Thyristors

Designed for industrial and consumer applications for full wave control of ac loads such as appliance controls, heater controls, motor controls, and other power switching applications.

- Sensitive Gate Allows Triggering by Microcontrollers and other Logic Circuits
- Blocking Voltage to 800 Volts
- On-State Current Rating of 12 Amperes RMS at 70°C
- High Surge Current Capability — 90 Amperes
- Rugged, Economical TO220AB Package
- Glass Passivated Junctions for Reliability and Uniformity
- Minimum and Maximum Values of I_{GT} , V_{GT} and I_H Specified for Ease of Design
- High Commutating di/dt — 8.0 A/ms Minimum at 110°C
- Immunity to dV/dt — 15 V/ μ sec Minimum at 110°C
- Operational in Three Quadrants: Q1, Q2, and Q3
- Device Marking: Logo, Device Type, e.g., MAC12SM, Date Code

MAXIMUM RATINGS ($T_J = 25^\circ\text{C}$ unless otherwise noted)

Rating	Symbol	Value	Unit
Peak Repetitive Off-State Voltage ⁽¹⁾ ($T_J = -40$ to 110°C , Sine Wave, 50 to 60 Hz, Gate Open)	V_{DRM} , V_{RRM}	600 800	Volts
On-State RMS Current (All Conduction Angles; $T_C = 70^\circ\text{C}$)	$I_T(\text{RMS})$	12	Amps
Peak Non-Repetitive Surge Current (One Full Cycle Sine Wave, 60 Hz, $T_J = 110^\circ\text{C}$)	I_{TSM}	90	Amps
Circuit Fusing Consideration ($t = 8.33$ ms)	I^2t	33	A^2sec
Peak Gate Power (Pulse Width = 1.0 μ sec, $T_C = 70^\circ\text{C}$)	P_{GM}	16	Watts
Average Gate Power ($t = 8.3$ msec, $T_C = 70^\circ\text{C}$)	$P_{G(AV)}$	0.35	Watt
Operating Junction Temperature Range	T_J	-40 to 110	$^\circ\text{C}$
Storage Temperature Range	T_{stg}	-40 to 150	$^\circ\text{C}$

(1) V_{DRM} and V_{RRM} for all types can be applied on a continuous basis. Blocking voltages shall not be tested with a constant current source such that the voltage ratings of the devices are exceeded.



ON Semiconductor

<http://onsemi.com>

TRIACS
12 AMPERES RMS
600 thru 800 VOLTS

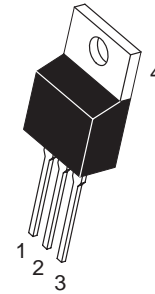
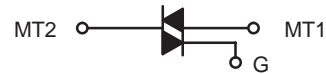

TO-220AB
CASE 221A
STYLE 4

PIN ASSIGNMENT	
1	Main Terminal 1
2	Main Terminal 2
3	Gate
4	Main Terminal 2

ORDERING INFORMATION

Device	Package	Shipping
MAC12SM	TO220AB	50 Units/Rail
MAC12SN	TO220AB	50 Units/Rail

Preferred devices are recommended choices for future use and best overall value.

MAC12SM, MAC12SN

THERMAL CHARACTERISTICS

Characteristic	Symbol	Value	Unit
Thermal Resistance — Junction to Case — Junction to Ambient	$R_{\theta JC}$ $R_{\theta JA}$	2.2 62.5	$^{\circ}C/W$
Maximum Lead Temperature for Soldering Purposes 1/8" from Case for 10 Seconds	T_L	260	$^{\circ}C$

ELECTRICAL CHARACTERISTICS ($T_J = 25^{\circ}C$ unless otherwise noted; Electricals apply in both directions)

Characteristic	Symbol	Min	Typ	Max	Unit
----------------	--------	-----	-----	-----	------

OFF CHARACTERISTICS

Peak Repetitive Blocking Current ($V_D = \text{Rated } V_{DRM}, V_{RRM}$; Gate Open)	I_{DRM} I_{RRM}	— —	— —	0.01 2.0	mA
	$T_J = 25^{\circ}C$ $T_J = 110^{\circ}C$				

ON CHARACTERISTICS

Peak On-State Voltage ⁽¹⁾ ($I_{TM} = \pm 17 A$)	V_{TM}	—	—	1.85	V
Gate Trigger Current (Continuous dc) ($V_D = 12 V, R_L = 100 \Omega$) MT2(+), G(+) MT2(+), G(-) MT2(-), G(-)	I_{GT}	0.8 0.8 0.8	1.5 2.5 2.7	5.0 5.0 5.0	mA
Holding Current ($V_D = 12 V$, Gate Open, Initiating Current = $\pm 200 mA$)	I_H	1.0	2.5	10	mA
Latching Current ($V_D = 12 V, I_G = 5 mA$) MT2(+), G(+) MT2(+), G(-) MT2(-), G(-)	I_L	2.0 2.0 2.0	3.0 5.0 3.0	15 20 15	mA
Gate Trigger Voltage (Continuous dc) ($V_D = 12 V, R_L = 100 \Omega$) MT2(+), G(+) MT2(+), G(-) MT2(-), G(-)	V_{GT}	0.45 0.45 0.45	0.68 0.62 0.67	1.5 1.5 1.5	V

DYNAMIC CHARACTERISTICS

Critical Rate of Change of Commutating Current ($V_D = 400 V, I_{TM} = 3.5 A$, Commutating $dV/dt = 10 V/\mu s$, Gate Open, $T_J = 110^{\circ}C, f = 500 Hz$, Snubber: $C_s = 0.01 \mu f, R_s = 15 \Omega$)	$(di/dt)_C$	8.0	10	—	A/ms
Critical Rate of Rise of Off-State Voltage ($V_D = 67\% V_{DRM}$, Exponential Waveform, $R_{GK} = 1 K\Omega$, $T_J = 110^{\circ}C$)	dV/dt	15	40	—	$V/\mu s$
Repetitive Critical Rate of Rise of On-State Current $IPK = 50 A$; $PW = 40 \mu sec$; $diG/dt = 1 A/\mu sec$; $I_{gt} = 100 mA$; $f = 60 Hz$	di/dt	—	—	10	$A/\mu s$

(1) Pulse Test: Pulse Width $\leq 2.0 ms$, Duty Cycle $\leq 2\%$.

MAC12SM, MAC12SN

Voltage Current Characteristic of Triacs (Bidirectional Device)

Symbol	Parameter
V_{DRM}	Peak Repetitive Forward Off State Voltage
I_{DRM}	Peak Forward Blocking Current
V_{RRM}	Peak Repetitive Reverse Off State Voltage
I_{RRM}	Peak Reverse Blocking Current
V_{TM}	Maximum On State Voltage
I_H	Holding Current

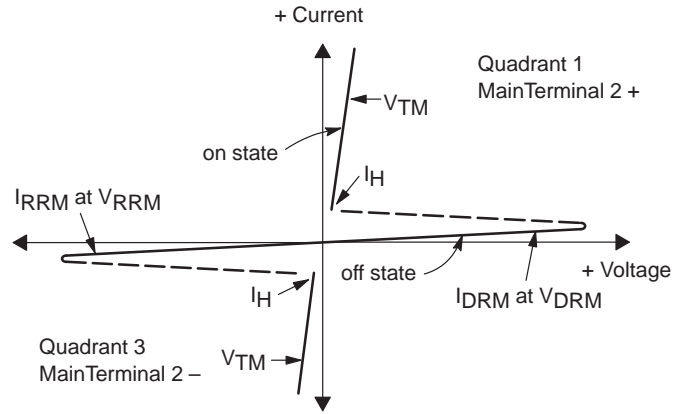

Quadrant Definitions for a Triac

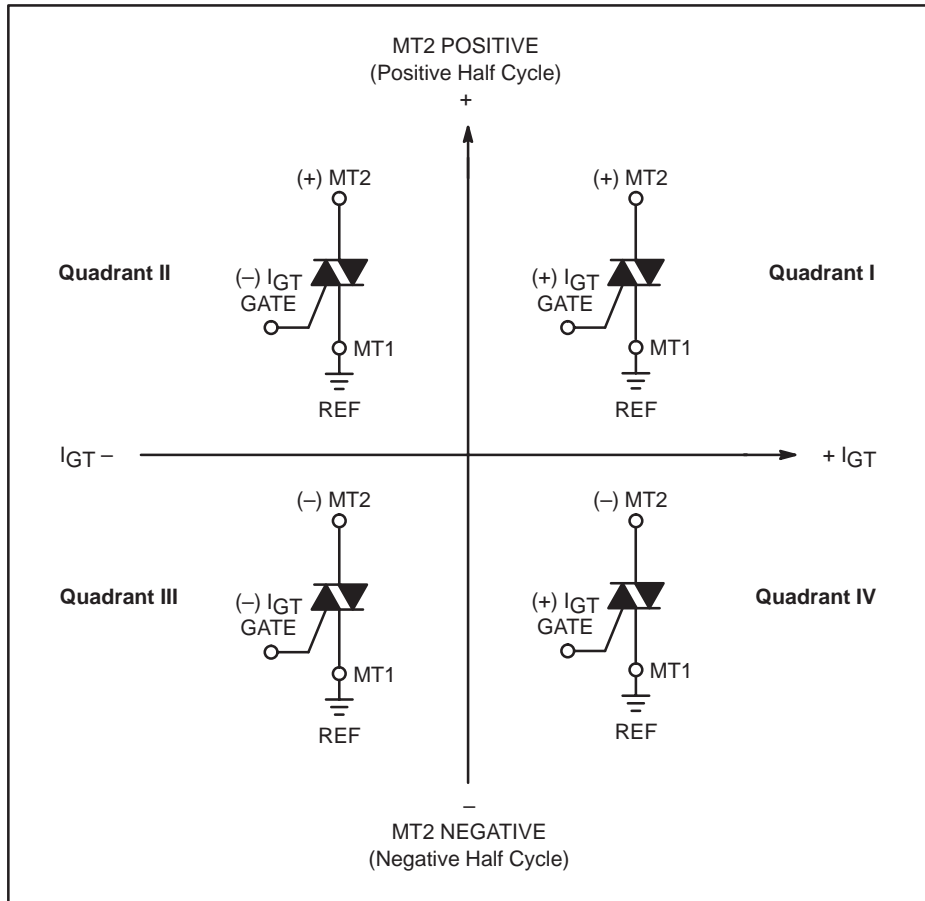

All polarities are referenced to MT1.

With in-phase signals (using standard AC lines) quadrants I and III are used.

MAC12SM, MAC12SN

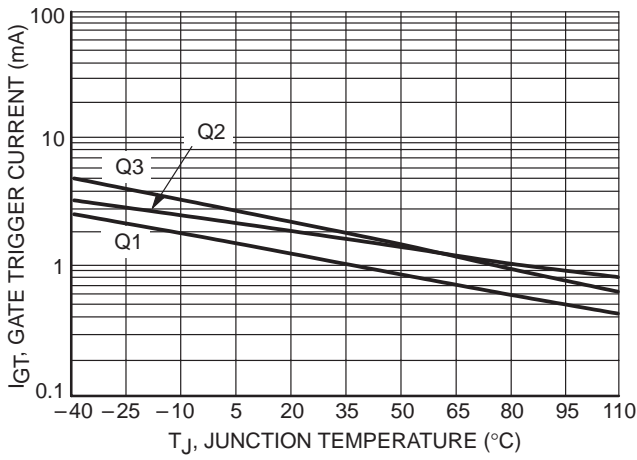

Figure 1. Typical Gate Trigger Current versus Junction Temperature

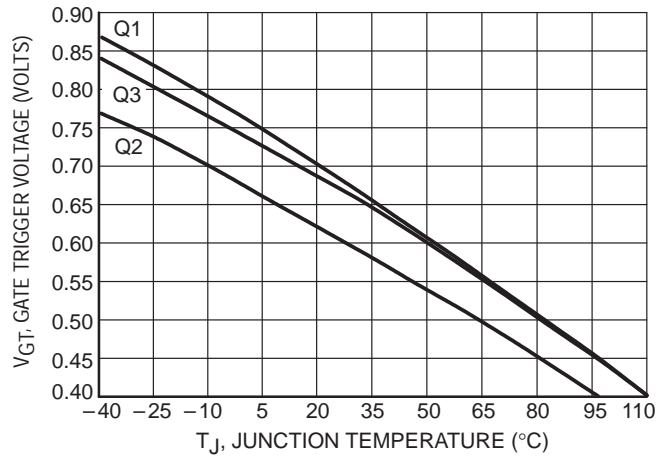

Figure 2. Typical Gate Trigger Voltage versus Junction Temperature

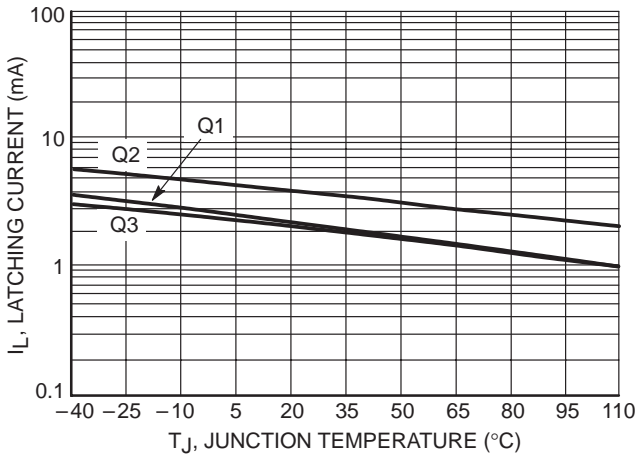

Figure 3. Typical Latching Current versus Junction Temperature

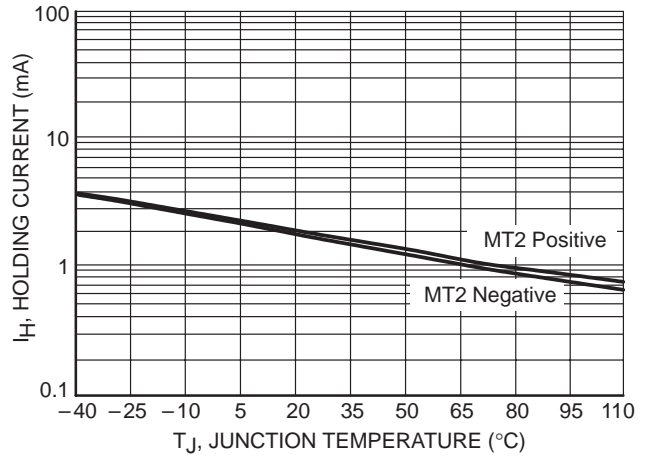

Figure 4. Typical Holding Current versus Junction Temperature

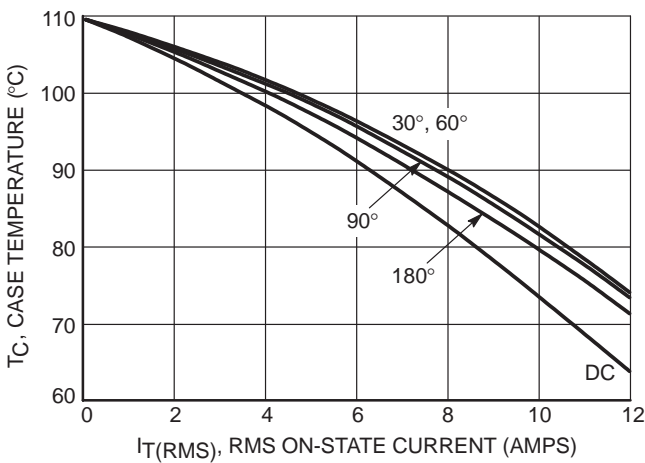

Figure 5. Typical RMS Current Derating

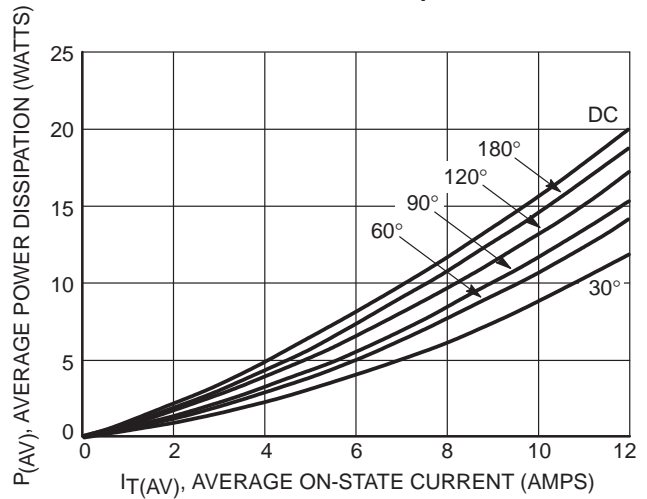

Figure 6. On-State Power Dissipation

MAC12SM, MAC12SN

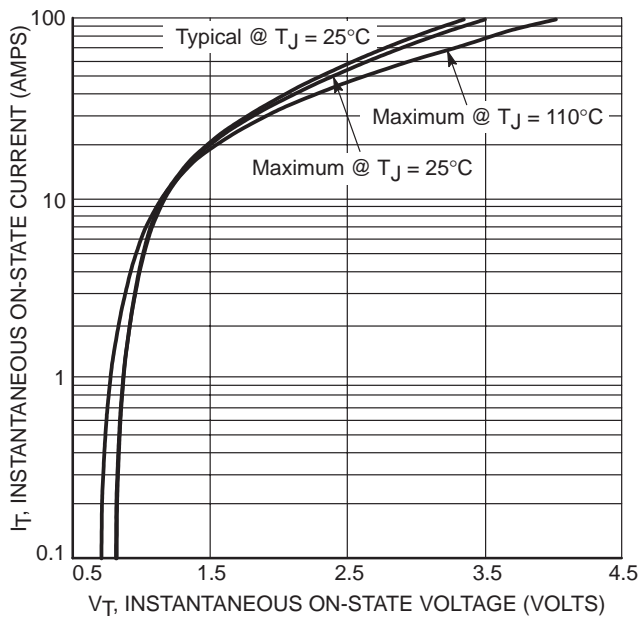

Figure 7. Typical On-State Characteristics

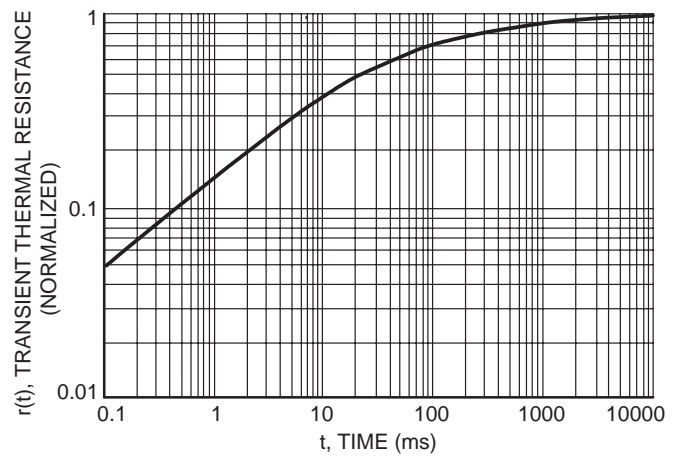
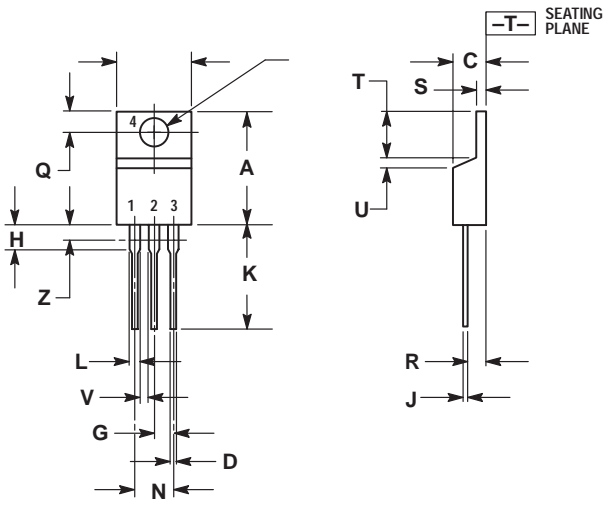

Figure 8. Typical Thermal Response

MAC12SM, MAC12SN

PACKAGE DIMENSIONS

TO-220AB
CASE 221A-09
ISSUE Z



- NOTES:
1. DIMENSIONING AND TOLERANCING PER ANSI Y14.5M, 1982.
 2. CONTROLLING DIMENSION: INCH.
 3. DIMENSION Z DEFINES A ZONE WHERE ALL BODY AND LEAD IRREGULARITIES ARE ALLOWED.

DIM	INCHES		MILLIMETERS	
	MIN	MAX	MIN	MAX
A	0.570	0.620	14.48	15.75
B	0.380	0.405	9.66	10.28
C	0.160	0.190	4.07	4.82
D	0.025	0.035	0.64	0.88
F	0.142	0.147	3.61	3.73
G	0.095	0.105	2.42	2.66
H	0.110	0.155	2.80	3.93
J	0.018	0.025	0.46	0.64
K	0.500	0.562	12.70	14.27
L	0.045	0.060	1.15	1.52
N	0.190	0.210	4.83	5.33
Q	0.100	0.120	2.54	3.04
R	0.080	0.110	2.04	2.79
S	0.045	0.055	1.15	1.39
T	0.235	0.255	5.97	6.47
U	0.000	0.050	0.00	1.27
V	0.045	---	1.15	---
Z	---	0.080	---	2.04

- STYLE 4:
PIN 1. MAIN TERMINAL 1
2. MAIN TERMINAL 2
3. GATE
4. MAIN TERMINAL 2

Notes

MAC12SM, MAC12SN

ON Semiconductor and  are trademarks of Semiconductor Components Industries, LLC (SCILLC). SCILLC reserves the right to make changes without further notice to any products herein. SCILLC makes no warranty, representation or guarantee regarding the suitability of its products for any particular purpose, nor does SCILLC assume any liability arising out of the application or use of any product or circuit, and specifically disclaims any and all liability, including without limitation special, consequential or incidental damages. "Typical" parameters which may be provided in SCILLC data sheets and/or specifications can and do vary in different applications and actual performance may vary over time. All operating parameters, including "Typicals" must be validated for each customer application by customer's technical experts. SCILLC does not convey any license under its patent rights nor the rights of others. SCILLC products are not designed, intended, or authorized for use as components in systems intended for surgical implant into the body, or other applications intended to support or sustain life, or for any other application in which the failure of the SCILLC product could create a situation where personal injury or death may occur. Should Buyer purchase or use SCILLC products for any such unintended or unauthorized application, Buyer shall indemnify and hold SCILLC and its officers, employees, subsidiaries, affiliates, and distributors harmless against all claims, costs, damages, and expenses, and reasonable attorney fees arising out of, directly or indirectly, any claim of personal injury or death associated with such unintended or unauthorized use, even if such claim alleges that SCILLC was negligent regarding the design or manufacture of the part. SCILLC is an Equal Opportunity/Affirmative Action Employer.

PUBLICATION ORDERING INFORMATION

NORTH AMERICA Literature Fulfillment:

Literature Distribution Center for ON Semiconductor
P.O. Box 5163, Denver, Colorado 80217 USA
Phone: 303-675-2175 or 800-344-3860 Toll Free USA/Canada
Fax: 303-675-2176 or 800-344-3867 Toll Free USA/Canada
Email: ONlit@hibbertco.com
Fax Response Line: 303-675-2167 or 800-344-3810 Toll Free USA/Canada

N. American Technical Support: 800-282-9855 Toll Free USA/Canada

EUROPE: LDC for ON Semiconductor – European Support

German Phone: (+1) 303-308-7140 (M-F 1:00pm to 5:00pm Munich Time)
Email: ONlit-german@hibbertco.com
French Phone: (+1) 303-308-7141 (M-F 1:00pm to 5:00pm Toulouse Time)
Email: ONlit-french@hibbertco.com
English Phone: (+1) 303-308-7142 (M-F 12:00pm to 5:00pm UK Time)
Email: ONlit@hibbertco.com

EUROPEAN TOLL-FREE ACCESS*: 00-800-4422-3781

*Available from Germany, France, Italy, England, Ireland

CENTRAL/SOUTH AMERICA:

Spanish Phone: 303-308-7143 (Mon-Fri 8:00am to 5:00pm MST)
Email: ONlit-spanish@hibbertco.com

ASIA/PACIFIC: LDC for ON Semiconductor – Asia Support

Phone: 303-675-2121 (Tue-Fri 9:00am to 1:00pm, Hong Kong Time)
Toll Free from Hong Kong & Singapore:
001-800-4422-3781
Email: ONlit-asia@hibbertco.com

JAPAN: ON Semiconductor, Japan Customer Focus Center
4-32-1 Nishi-Gotanda, Shinagawa-ku, Tokyo, Japan 141-8549

Phone: 81-3-5740-2745
Email: r14525@onsemi.com

ON Semiconductor Website: <http://onsemi.com>

For additional information, please contact your local Sales Representative.