



SMT Mini Wideband Transformers – WBC



- Smallest wideband transformer: 4 mm square 3 mm high
- 300 V interwinding isolation, 1/4 Watt RF input power
- 250 mA max current rating.

Designer's Kit C393 contains three of each part

Core material Ferrite

Terminations RoHS compliant tin-silver-copper over silver-platinum-glass frit. Other terminations available at additional cost.

Weight 68.0 – 88.8 mg

Ambient temperature –40°C to +85°C

Storage temperature Component: –40°C to +85°C.

Packaging: –40°C to +80°C

Resistance to soldering heat Max three 40 second reflows at +260°C, parts cooled to room temperature between cycles

Moisture Sensitivity Level (MSL) 1 (unlimited floor life at <30°C / 85% relative humidity)

Failures in Time (FIT) / Mean Time Between Failures (MTBF)

60 per billion hours / 16,666,667 hours, calculated per Telcordia SR-332

Packaging 750/7" reel; 3000/13" reel Plastic tape: 12 mm wide, 0.3 mm thick, 8 mm pocket spacing, 2.9 mm pocket depth

PCB washing Only pure water or alcohol recommended

Part number ¹	Schematic	Impedance ratio ² pri : sec	Bandwidth (MHz)	Insertion loss max (dB)	Pins 4–6 (primary)		Pins 1–3 (secondary)		DC imbalance ⁵ max (mA)	Color dot
					L min ³ (μH)	DCR max ⁴ (mOhm)	L min ³ (μH)	DCR max ⁴ (mOhm)		
WBC1-1L_	A	1 : 1	0.400 – 600	0.40	10	120	10	120	—	Brown
WBC1-1TL_	B	1 : 1	0.250 – 750	0.58	11	75	11	75	36	Brown
WBC2-1TL_	B	1 : 2	0.200 – 500	0.50	10	120	20	150	8.5	Red
WBC3-1TL_	B	1 : 3	0.300 – 900	0.60	9	100	27	150	8.5	Orange
WBC4-1TL_	B	1 : 4	0.250 – 750	1.0	12	55	48	120	30	Yellow
WBC4-14L_	B	1 : 4	1.500 – 1200	2.0	2	50	8	100	15	Green
WBC4-1WL_	B	1 : 4	0.500 – 1000	0.90	5	60	20	120	10	White
WBC4-6TL_	B	1 : 4	0.300 – 700	0.65	9	80	36	200	7.5	Blue
WBC8-1L_	B	1 : 8	0.150 – 600	0.60	22	120	176	310	17	Gray
WBC9-1L_	B	1 : 9	0.300 – 500	0.54	9	80	81	230	5	White
WBC16-1TL_	B	1 : 16	0.600 – 300	0.80	5	60	80	230	5	Violet
WBC4-4L_	C	1 : 4	0.250 – 800	1.0	12	60	48	120	30	Yellow

1. When ordering, please specify **termination** and **packaging** codes:

WBC4-4 L C

Termination: L = RoHS compliant tin-silver-copper (95.5/4/0.5) over silver-palladium-platinum
Special order: S = non-RoHS tin-lead (63/37).

Packaging: C = 7" machine-ready reel. EIA-481 embossed plastic tape (750 parts per full reel).

B = Less than full reel. In tape, but not machine ready. To have a leader and trailer added (\$25 charge), use code letter C instead.

D = 13" machine-ready reel. EIA-481 embossed plastic tape. Factory order only, not stocked (3000 parts per full reel).

- Impedance ratio is for the full primary winding to the full secondary winding.
- Inductance measured at 100 kHz, 0.1 V, 0 Adc on an Agilent/HP 4192 or equivalent.
- DCR measured on a micro-ohmmeter.
- DC imbalance is the maximum difference in current measured at pins 1 and 3 with the source at pin 2. Inductance drop is 15% at maximum imbalance.
- Electrical specifications at 25°C. Measurements are referenced to 50 Ohms. Refer to Doc 362 "Soldering Surface Mount Components" before soldering.

Schematics

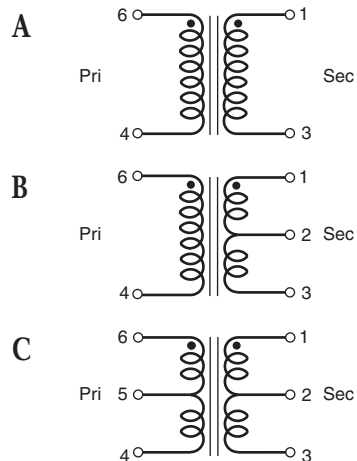

Coilcraft®

Specifications subject to change without notice.
Please check our website for latest information.

Document 424-1 Revised 02/17/09

1102 Silver Lake Road Cary, Illinois 60013 Phone 847/639-6400 Fax 847/639-1469

E-mail info@coilcraft.com Web <http://www.coilcraft.com>



WBC Series SMT Mini Wideband Transformers

Dimensions

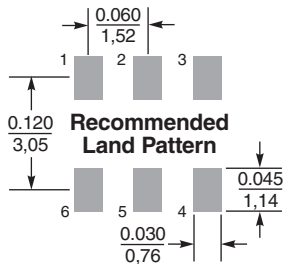
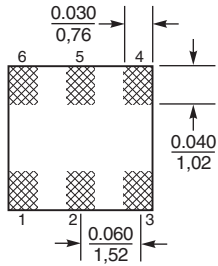
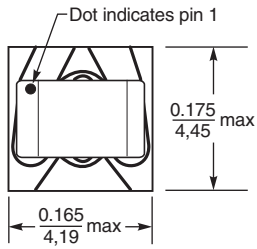

Dimensions are in $\frac{\text{inches}}{\text{mm}}$



Specifications subject to change without notice.
Please check our website for latest information.

Document 424-2 Revised 02/17/09

1102 Silver Lake Road Cary, Illinois 60013 Phone 847/639-6400 Fax 847/639-1469
E-mail info@coilcraft.com Web <http://www.coilcraft.com>



WBC Series SMT Mini Wideband Transformers

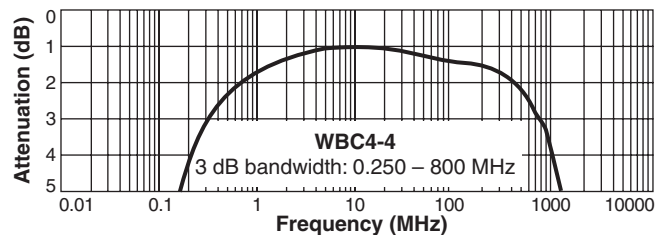
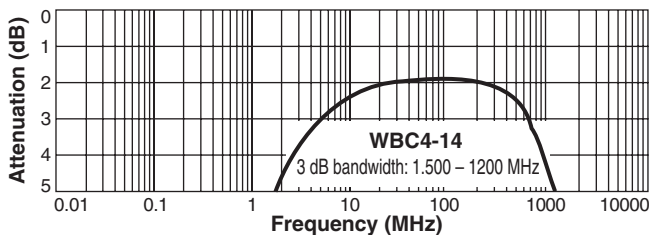
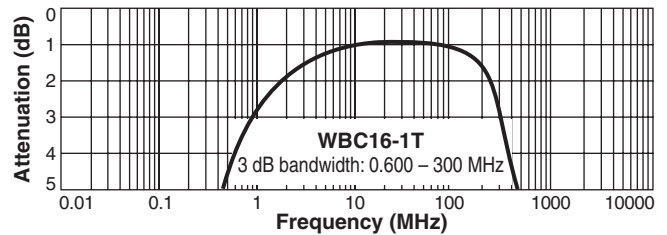
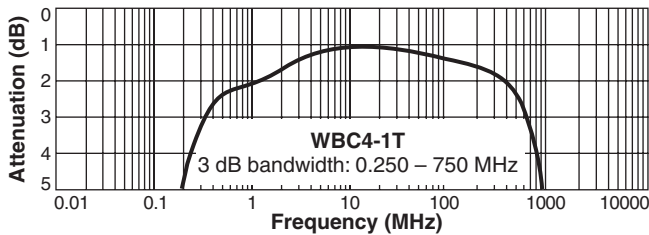
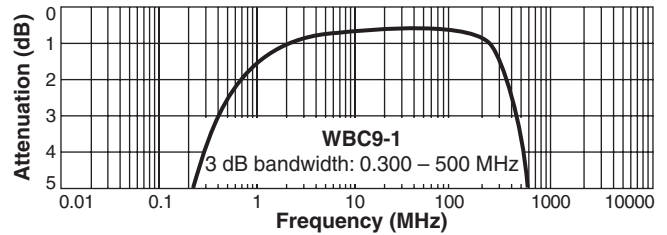
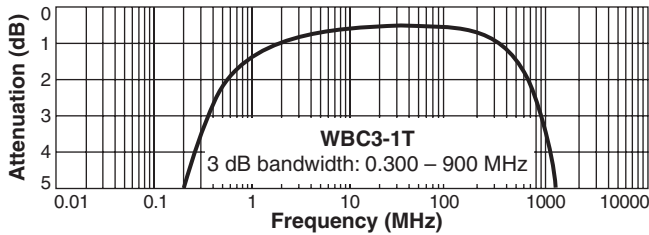
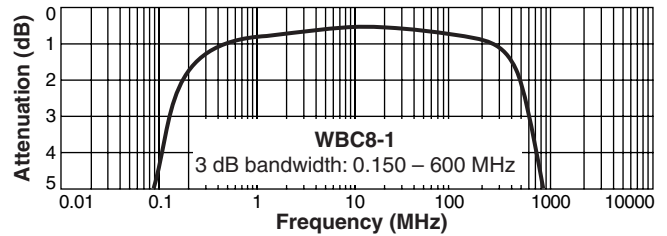
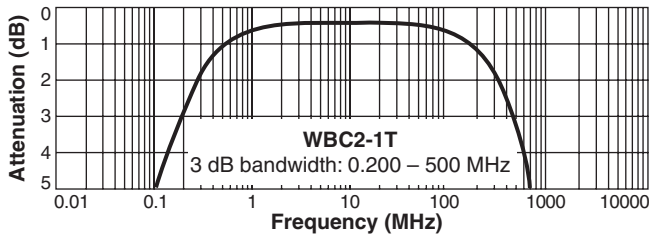
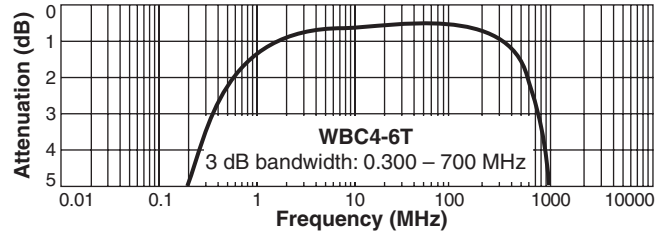
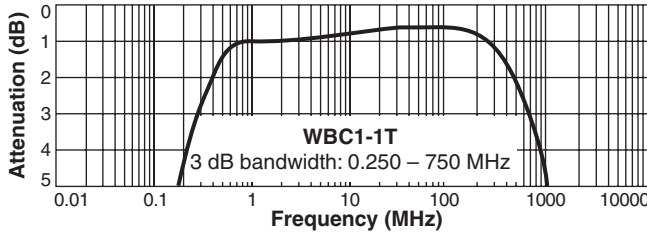
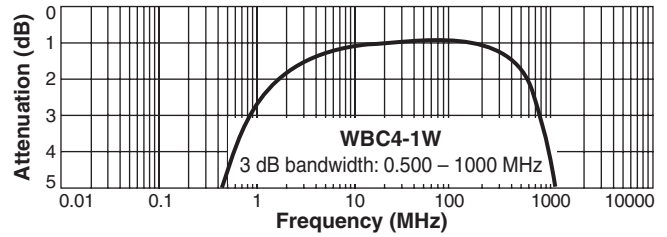
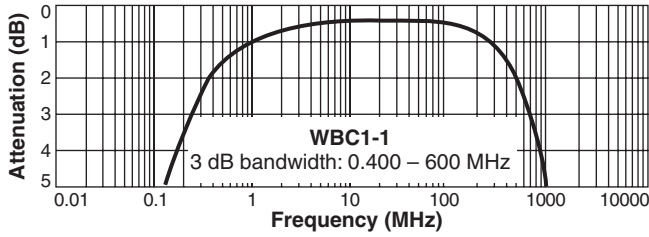

Attenuation measured on a network analyzer (re: 50 Ohms)



Specifications subject to change without notice.
Please check our website for latest information.

Document 424-3 Revised 02/17/09

1102 Silver Lake Road Cary, Illinois 60013 Phone 847/639-6400 Fax 847/639-1469

E-mail info@coilcraft.com Web <http://www.coilcraft.com>