



MAGNETEK
UNCOMMON POWER

HEHB-70A-48V-1.8V

48V_{in} 70A_{out} 1.8V_{out} DC-DC Converter
High Efficiency, Isolated Half Brick

Features

- Very high efficiency: 91% at 35A load, 89% at full rated load current
- Wide input voltage range (35 to 75Vdc)
- Total weight: 77 grams (2.67 oz.) Open-Frame Version
- Low profile, industry standard footprint and pinout: 2.3" x 2.4" x 0.44" (58.4mm x 61.0mm x 11.2mm)
- Back Bias protection
 - Monolithic start-up, with pre-biased output
- Parallel for increased power:
 - External Clock Synchronization (Option)
 - Current Share, Primary (Option)
- Soft Start
- Remote ON/OFF
- Output voltage trim – Industry standard trim equation
- Remote sense
- Fixed Switching Frequency
 - (Output ripple frequency @ 420 KHz)
- Under voltage lockout (UVLO), Input – auto recover
- Over voltage protection – auto recover
- Over current protection – auto recover
- Over temperature protection – auto recover
- Operating temperature range: -40°C to +100°C
- Input to Output Isolation at 2000Vdc, 10MΩ
- Pending- UL/cUL, CSA/CSA_{US}, TUV and KEMA
- ISO 9001 Certified manufacturing processes



Product Highlights

- HEHB Family of dc-dc converters is Magnetek's solution for next generation, cutting-edge board applications.
- Synchronous rectification uses MOSFET instead of Schottky diodes providing extreme reduction in heat generation, boosting efficiency, eliminating the need for a heat sink and increased reliability.
- Low profile (0.44"), open frame construction allows smaller card pitch and improves system ventilation.
- Fixed switching frequency provides predictable EMI characteristics.

HEHB-70A-48V-1.8V

Mechanical Drawings

- All dimensions are in inches (mm)
Tolerances: x.xx in. +/-0.2 in. (0.5mm)

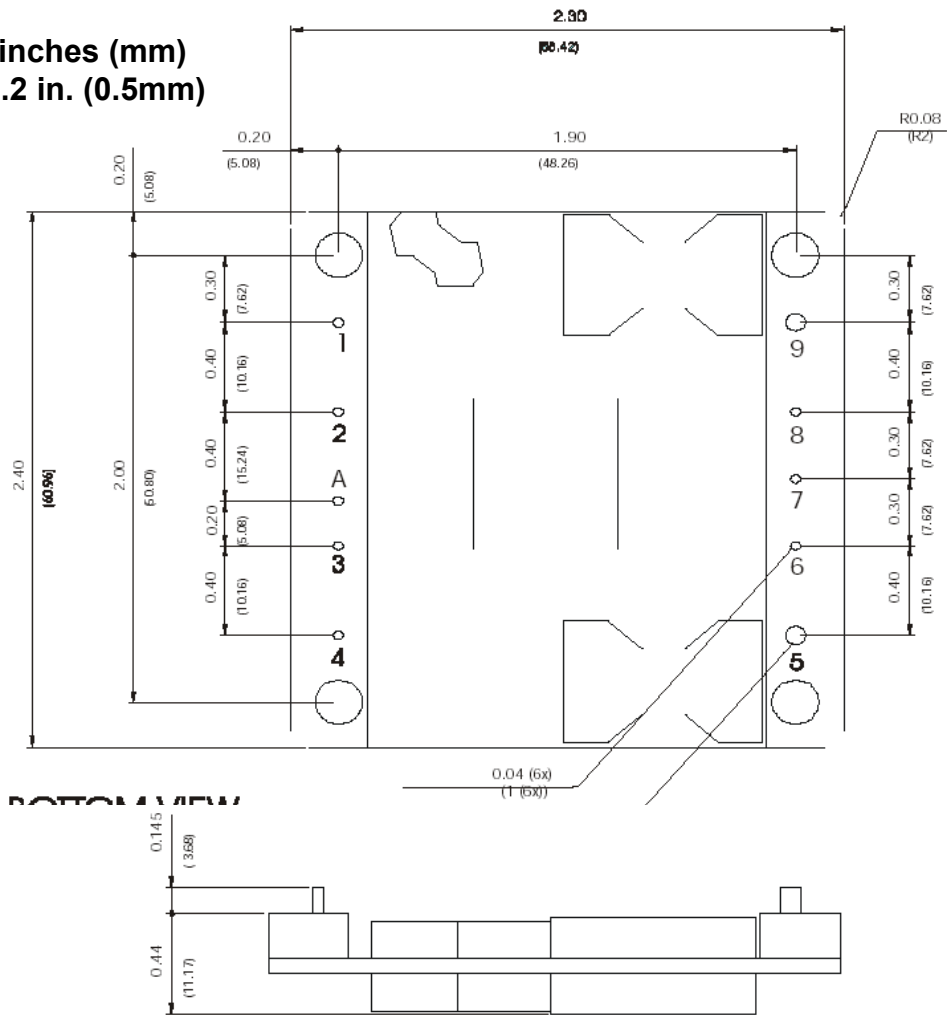

SIDE VIEW

PINOUT Description		
Pin	Name	Function
1	Vin (-)	Negative terminal for the input bus
2	(No Pin)	Optional Current Share, -F Only
A	(No Pin)	Optional Clock Sync, -F Only
3	ON/OFF	Remote Enable/Disable terminal, input signal TTL
4	Vin (+)	Positive terminal for the input bus
5	Vout (+)	Positive terminal for output voltage
6	Sense (+)	Positive remote sense
7	TRIM	Output voltage TRIM
8	Sense (-)	Negative remote sense
9	Vout (-)	Return terminal for output voltage

Specifications

HEHB-70A-48V-1.8V

(Typical values are at nominal input line, full load, airflow 300 LFM, 25°C ambient temperature unless otherwise specified)

Input Characteristics	Notes & Conditions	Min	Typ	Max	Units
Operating Input Voltage Range	Note 1	35	48	75	V
Input Surge Voltage	T < 100msec			100	V
Input Under-Voltage Lockout					
<i>Turn-On Voltage Threshold</i>				35.4	V
<i>Turn-Off Voltage Threshold</i>				32.1	V
<i>Lockout Hysteresis Voltage</i>			3.3		V
Maximum Input Current (I_{INmax})	$V_{IN}=36V$; Full Load at nominal output voltage			4.2	A
No-load Input Current			60	70	mA
Off Converter Input Current			11	13	mA
Inrush Current Transient Rating			0.03		A ² s
Input Reflected-Ripple Current	RMS; see figures 6,7,8		2	5	mA

Output Characteristics	Notes & Conditions	Min	Typ	Max	Units
Output Voltage Set Point	50 % Load	1.78	1.80	1.82	V
Output Voltage Regulation					
<i>Over Load</i>			± 5	± 10	mV
<i>Over Line</i>			± 4	± 6	mV
<i>Over Temperature</i>			± 10	± 20	mV
Total Output Voltage Range	over sample, line, load, temperature and life	1.75		1.85	V
Output Voltage Ripple and Noise	20 MHz bandwidth				
<i>Peak to Peak</i>	Full load		25	50	mV
<i>RMS</i>	see figures 6 & 9		5	10	mV
Operating Output Current Range		0	-	70	A
Output DC Current Limit Inception (hiccup mode: 30msec ON, 220msec OFF)	See Figure 5	77		84	A
Admissible Output Capacitance	Full load, resistive	0		50,000	μF

Dynamic Characteristics	Notes & Conditions	Min	Typ	Max	Units
Output Voltage during Load Current Transient	15μF load cap. 5A/μs; see figure 3,4				
<i>Positive Step Change in I_{OUT}</i>	50% to 75% Iout max		40		mV
<i>Negative Step Change in I_{OUT}</i>	75% to 50% Iout max		150		mV
<i>Settling Time to 1% of $V_{out nom}$</i>				200	μs
Turn On Transient	See figures 1, 2				
<i>Turn On Time</i>	Full load		160	200	ms
<i>Output Voltage Overshoot</i>	10,000 μF load capacitance, Iout= 0A		0		%

Efficiency	Notes & Conditions	Min	Typ	Max	Units
100% Load	$V_{in} = 50V$		89		%
75% Load			90		%
50% Load			91		%

NOTE 1 : Absolute max. continuous input voltage = 80V (operating) ; 100V (Surge).

HEHB-70A-48V-1.8V

Isolation Characteristics	Notes & Conditions	Min	Typ	Max	Units
Isolation Voltage input to output	Basic isolation	2000			V _{DC}
Isolation Voltage Input to plate	Basic isolation	2000			V _{DC}
Isolation Capacitance			3300		pF
Isolation Resistance		10			MΩ

General Characteristics	Notes & Conditions	Min	Typ	Max	Units
Operating Range Temperature	With appropriate power derating	-40		+100	°C
Storage Temperature	Maximum Rating	-50		+120	°C
Relative Humidity	Non condensing	5		95	%
Calculated MTBF	Bellcore Issue 4 RDF93 HRD Issue 5	TBA			

Feature Characteristics		Min.	Typ.	Max	Units
Switching frequency			420		kHz
ON/OFF Control					
<i>Off-State Voltage</i>		1.5		5	V
<i>On-State Voltage</i>		0		1.2	V
Output Voltage Trim Range		-20		+10	%
Current Share (-F Option)	50% of I _{MAX}		± 3	± 5	%
Output Over-Voltage Protection		115	120	130	%
Over-Temperature shutdown	PCB Hot spot		125		°C

Safety and Regulatory (PENDING)	
TUV and KEMA certified for basic insulation compliance to EN06950 requirements	
UL and CSA 22.2 No. 950-95(US and Canada) certified with basic insulation for compliance to UL60950.	
Note : An external input fuse must always be used for compliance to listed safety requirements.	
CE compliant per 72/23/EEC (Low voltage directive) and 93/68/EEC to facilitate CE Mark at system level.	
Material flammability rating, UL94V-0	
NEBS compliant	

HEHB-70A-48V-1.8V

Performance Curves

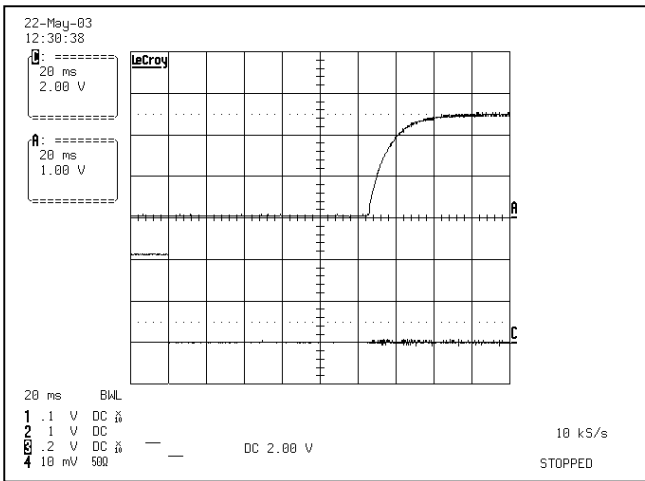

Figure 1. Turn-on transient at full rated current (20 ms/div)
 Top trace: Vout (1V/div)
 Bottom trace: ON/OFF input (2 V/div)

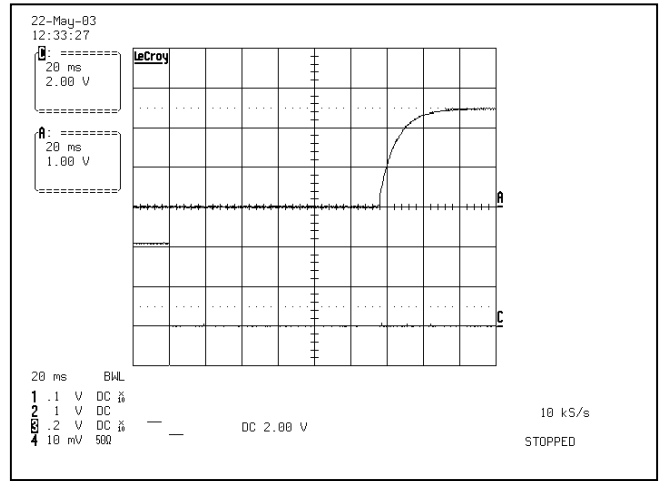

Figure 2. Turn-on transient at zero load (20 ms/div)
 Top trace: Vout (1V/div)
 Bottom trace: ON/OFF input (2 V/div)

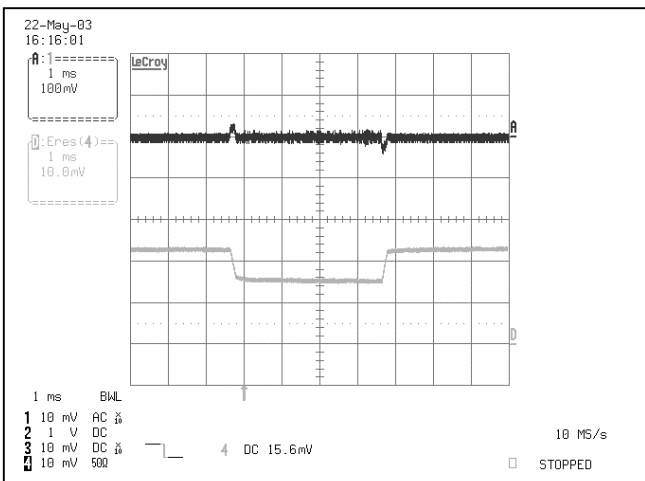

Figure 3. Output voltage response to dynamic change in load current: 75% I_o to 50% I_o , where:
 $di / dt = 5 \text{ A} / \mu\text{s}$
 Load capacitance: 15 μF , 30 m Ω ESR tantalum 1 μF ceramic capacitor
 Top trace: Vout (100mV/div), Bottom trace: Iout (20A/div)

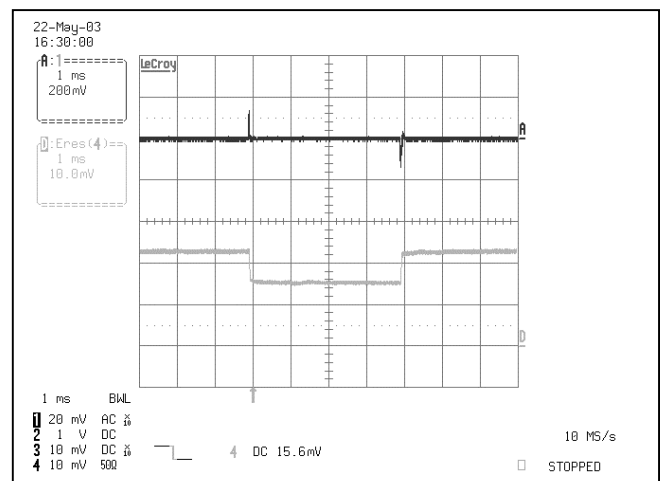

Figure 4. Output voltage response to dynamic change in load current: 75% I_o to 50% I_o , where:
 $di / dt = 1 \text{ A} / \mu\text{s}$
 Load capacitance: 15 μF , 30 m Ω ESR tantalum 1 μF ceramic capacitor
 Top trace: Vout (200mV/div), Bottom trace: Iout (20A/div)

HEHB-70A-48V-1.8V

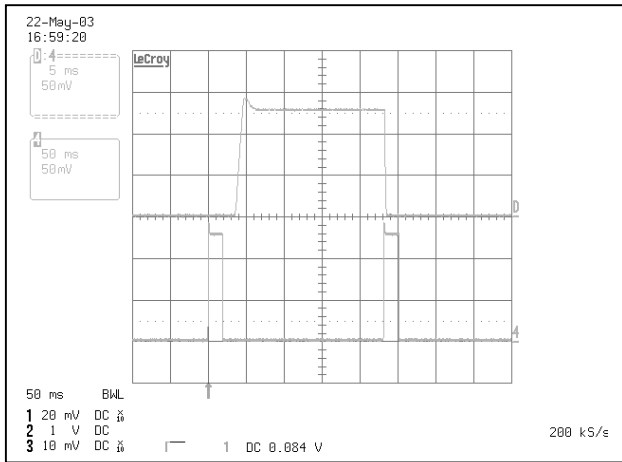

Figure 5. Output current (50A/div) as a function of time when the converter attempts to turn on into a 10 mΩ short circuit. Top trace is an expansion of the on time portion of the bottom trace (5 ms/div)

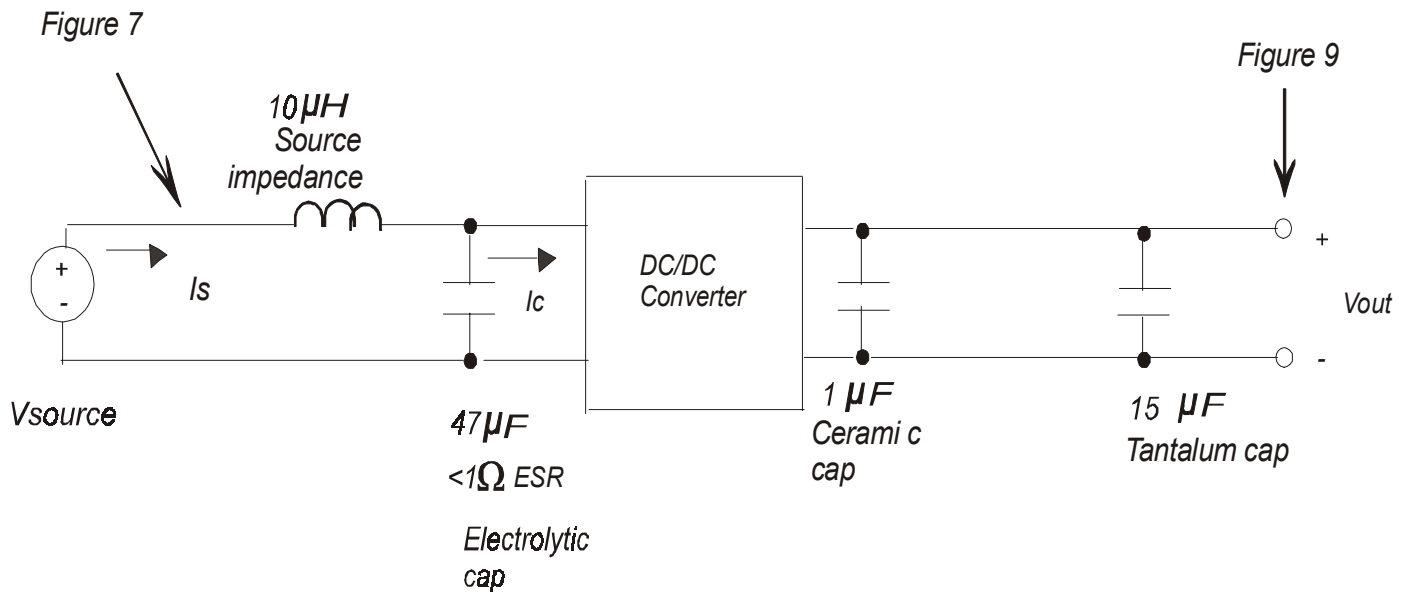

Figure 6. Test set-up diagram showing measurement point for Input Reflected Ripple Current and Output Voltage Ripple.

HEHB-70A-48V-1.8V

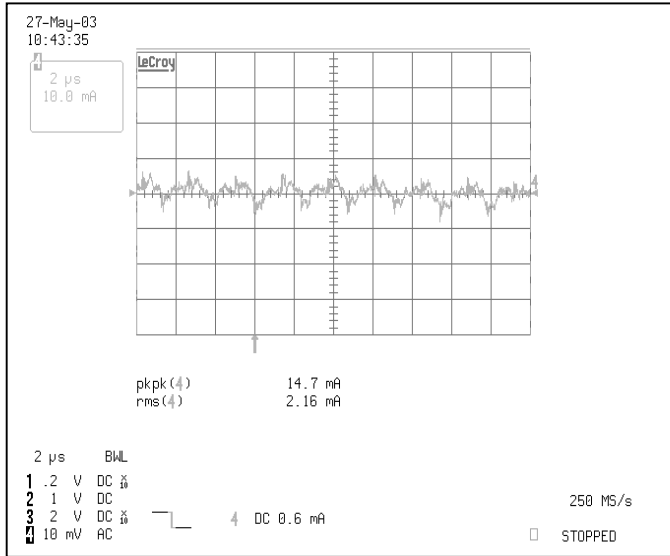

Figure 7. Input Reflected Ripple Current, set-up per figure 6; 10μH source impedance. Nominal input voltage at full rated load.

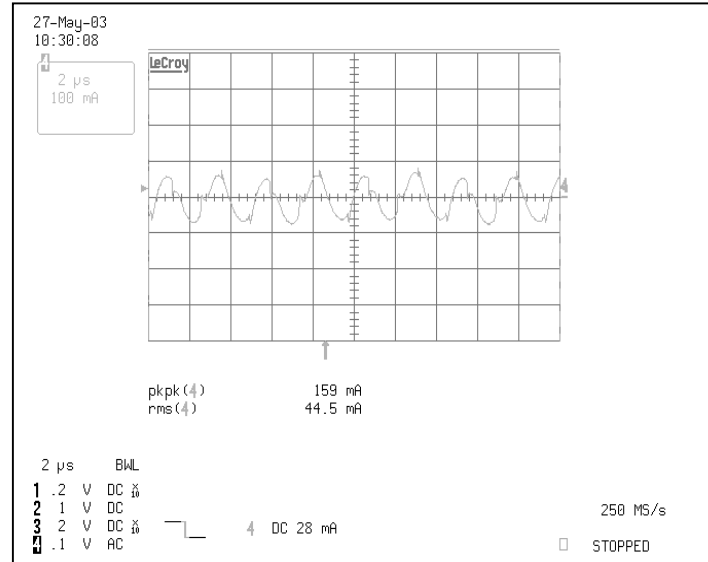

Figure 8. Input terminal ripple current (ic) at full rated load and nominal input voltage.

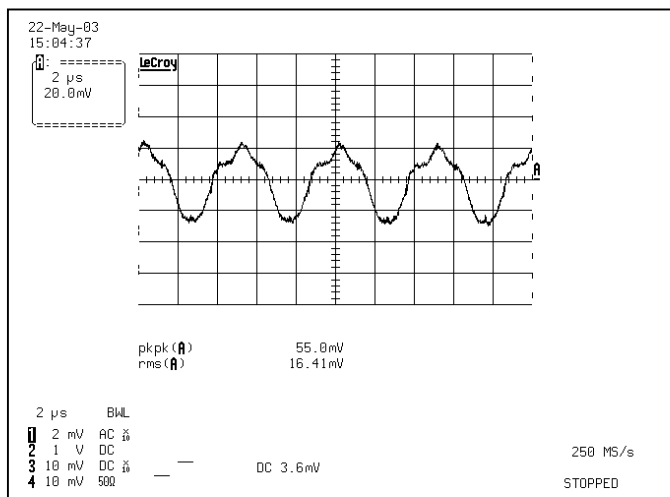

Figure 9. Output voltage ripple at nominal input voltage and rated load current (20 mV/div). Load capacitance.: 1μF ceramic capacitor 30μF tantalum capacitor. Bandwidth: 20 MHz. (See Fig. 6)

HEHB-70A-48V-1.8V

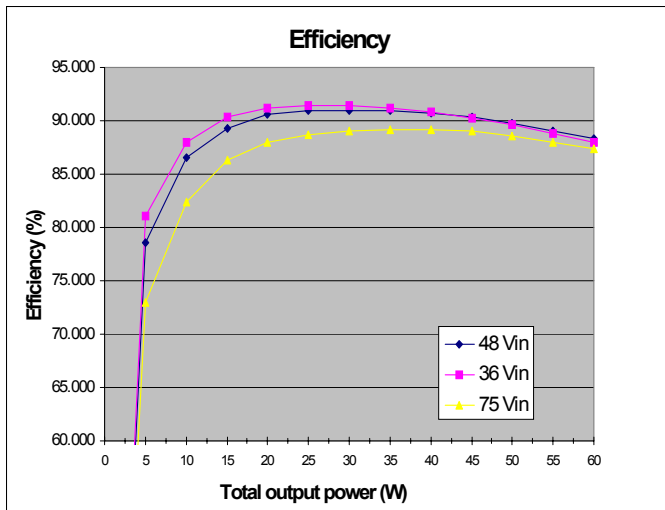

Figure 10. Output voltage vs. load current showing typical current limit curves and converter shutdown points

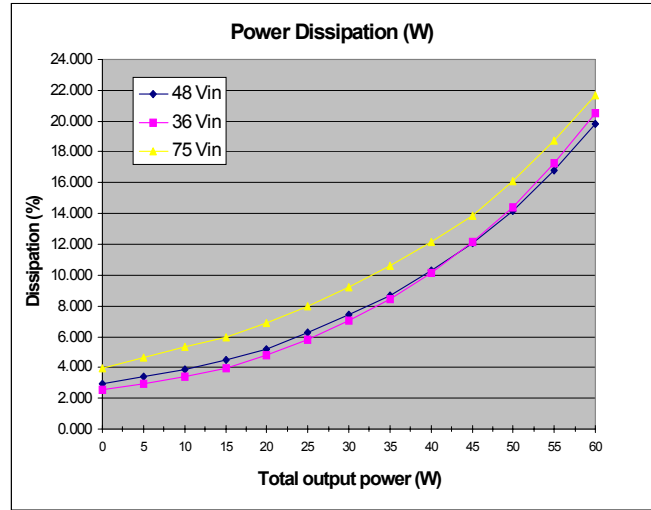

Figure 11 Power dissipation vs. load current for minimum, nominal and maximum input voltage at 25°C.

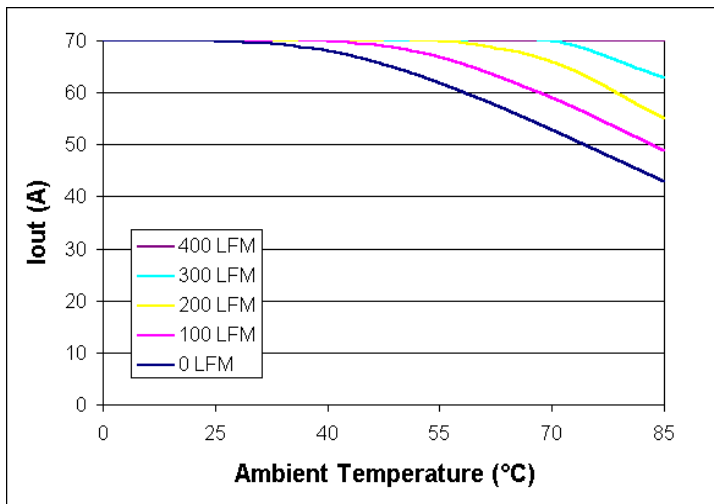

Figure 12: Maximum output current de-rating curves vs. ambient air temperature for airflow rates of 0 LFM through 400 LFM with air flowing from input to output and nominal input voltage.

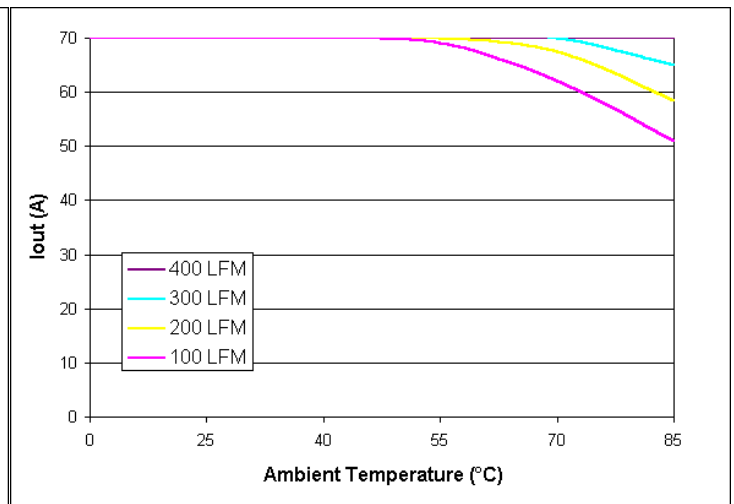

Figure 13: Maximum output current de-rating curves vs. ambient air temperature for airflow rates of 100 LFM through 400 LFM with air flowing from pin 1 to pin 4 (Transversal) and nominal input voltage.

HEHB-70A-48V-1.8V

Features and Pins description

REMOTE ON-OFF CONTROL

The default logic is negative, where the Remote On/Off (pin 2) input is referenced to -Vin (pin 1). The Remote On/Off signal must be lower than 0.8V to enable the output voltage, and higher than 2.7V to disable the output voltage.

Positive logic is an available option, add “-P” to the end of the ordering code.

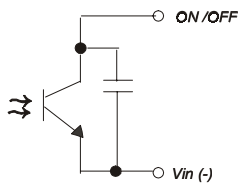

Remote Enable Circuit

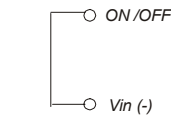

Negative logic
(permanently Enabled)

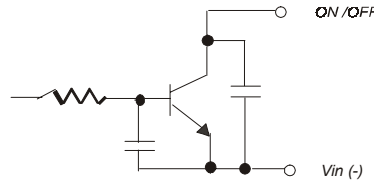

Open Collector Enable Circuit

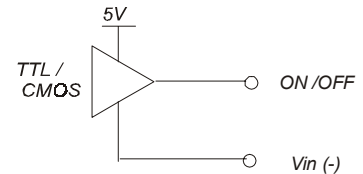

Direct Logic Drive

TRIMMING

The output voltage can be trimmed by means of an external resistor connected between Trim (pin 6) and +Sense (pin 6) or -Sense (pin 8). The selection of the resistor follows the industry standard trim equation.

An external resistor connected between Trim and -Sense pins will decrease the output voltage. For a decrease of $\Delta\%$ of the nominal output voltage, calculate the value of the external resistor using the following equation:

$$R_{\text{trim-down}} = \left(\frac{100\%}{\Delta} \right) - 2k\Omega, \quad \text{where } \Delta = \left(\frac{V_{\text{nominal}} - V_{\text{target}}}{V_{\text{nominal}}} \right) \times 100\%$$

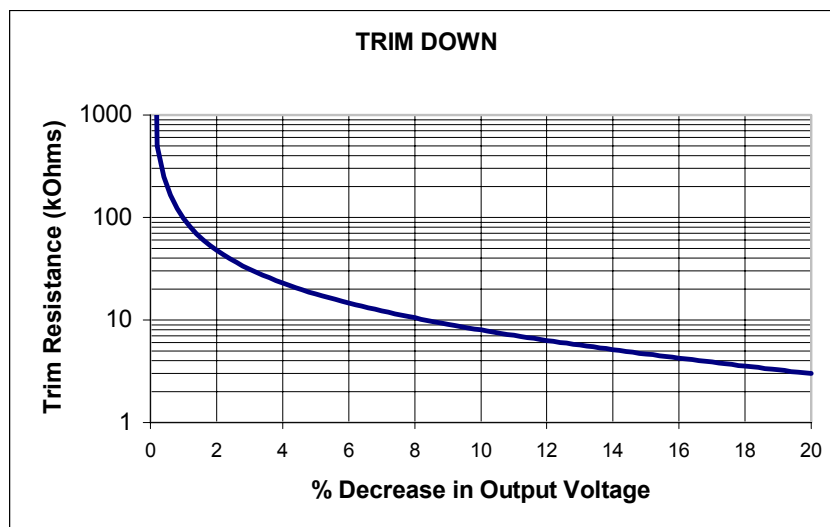

HEHB-70A-48V-1.8V

A resistor connected between Trim and + S pins will increase the output voltage. For a desired increase of $\Delta\%$ of the nominal output voltage, the value of the resistor should be:

$$R_{\text{trim-up}} = \frac{\left(\frac{V_{\text{nom}}}{V_{\text{ref}}} - 2 \right) \cdot V_{\text{tar}} + V_{\text{nom}}}{V_{\text{tar}} - V_{\text{nom}}} k\Omega,$$

Where V_{nom} = Nominal Voltage, V_{tar} = Target Voltage, $V_{\text{ref}} = 1.225 \text{ V}$

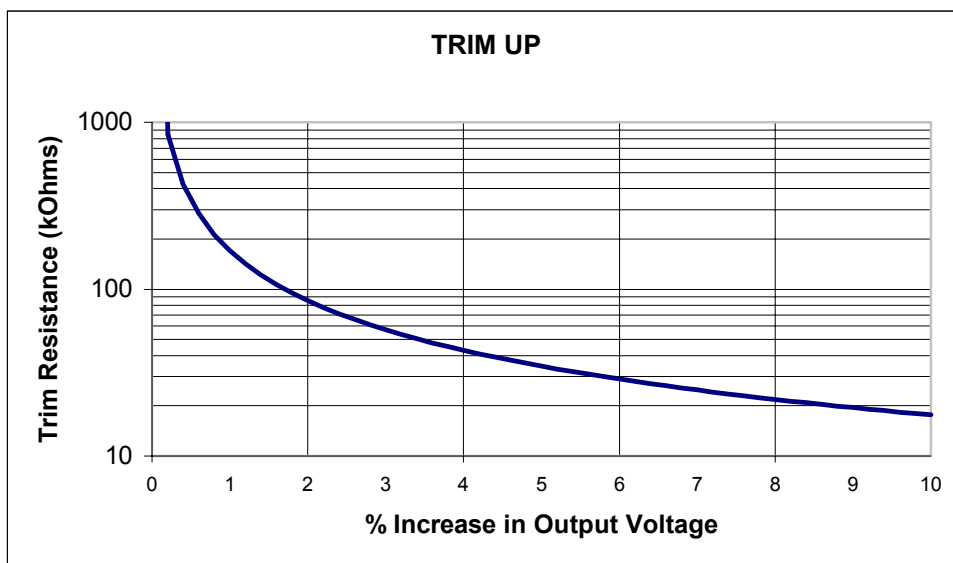

SENSE (+ or -)

The +Sense or –Sense pins must be connected to the load or output pins of the converter. To ensure tight regulation at the system critical load, then the remote sense pins should be connected to the system critical load. Reference applicable section of data sheet for maximum voltage compensation.

Ensure sufficient margin to the over voltage threshold, review applicable sections of the data sheet and system loading: output over-voltage protection –Vs- system transient load condition(s).

HEHB-70A-48V-1.8V

THERMAL CONSIDERATIONS

The converter has internal thermal protection preventing hot spots on PCB from exceeding MFR's recommended temperatures for reliable operation, reference over temperature protection threshold (Section: Feature Characteristics). Margin to the temperature protection limit should be verified in the application, and should not exceed 120°C on the thermal reference points as shown in Figure 14.

During an abnormal condition inducing an increase in the converter temperature, the converter output voltage will fold back when the over temperature protection threshold is reached. The converter will auto-recover when the fault condition is corrected and time allowed for the converter to cool down.

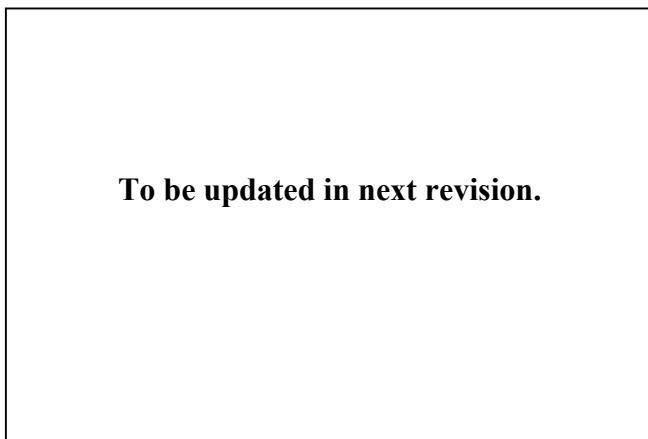

Figure 14, Thermal reference points

OVER CURRENT PROTECTION

The overcurrent limit inception is typically 110% of the rated output current will cause the output voltage enter fault protection, or hiccup reference Figure 5. The converter will enter fault protection typically at 125% of rated output current. When the fault is removed the converter will auto recover.

HEHB-70A-48V-1.8V

Ordering information:

Product Family Code	Rated Output Current	Input Voltage	Output Voltage	Option 1- Remote On/Off Logic	Option 2- Mechanical	Option 3- Parallel Functions	Option 4- Pin Length
HEHB	70A	48V	1.8V	Default → Negative P → Positive	Default → Open Frame PL → Cold Plate	Default → None F → Clock Sync & Current share	Default → 0.15" 1 → 0.25" 2 → 0.11"

Example HEHB-70A-48V-1.8V-PPLF1 Standard Half Brick with Positive Logic Remote On/Off, Cold Plate, (Clock Sync and Current Share) and 0.25" pin length options.

Europe
Magnetek S. p. A
 Via S. Giorgio 642
 52028- Terranuova Bracciolini, Arezzo, Italy
 Phone: (+39) 055.9195.1
 Fax: (+39) 055.9195.248

US
Magnetek Inc.
 8966 Mason Avenue
 Chatsworth, CA 91311, USA
 Phone: (+1) 818.727.2216
 Fax: (+1) 818.727.2276
 Toll-Free Number: (+1) 800.621.0733