

# BF1206F

Dual N-channel dual gate MOSFET

Rev. 01 — 30 January 2006

Product data sheet

## 1. Product profile

---

### 1.1 General description

The BF1206F is a combination of two different dual gate MOSFET amplifiers with shared source and gate2 leads.

The source and substrate are interconnected. Internal bias circuits enable Direct Current (DC) stabilization and a very good cross-modulation performance during Automatic Gain Control (AGC). Integrated diodes between the gates and source protect against excessive input voltage surges. The transistor is encapsulated in a SOT666 micro-miniature plastic package.

#### CAUTION



This device is sensitive to ElectroStatic Discharge (ESD). Therefore care should be taken during transport and handling.

### 1.2 Features

- Two low noise gain controlled amplifiers in a single package
- Superior cross-modulation performance during AGC
- High forward transfer admittance
- High forward transfer admittance to input capacitance ratio
- Suited for 3 volt applications

### 1.3 Applications

- Gain controlled low noise amplifiers for Very High Frequency (VHF) and Ultra High Frequency (UHF) applications with 3 V supply voltage, such as digital and analog television tuners

# PHILIPS

## 1.4 Quick reference data

**Table 1: Quick reference data**

Per MOSFET unless otherwise specified.

Symbol	Parameter	Conditions	Min	Typ	Max	Unit
$V_{DS}$	drain-source voltage (DC)		-	-	6	V
$I_D$	drain current (DC)		-	-	30	mA
$ y_{fs} $	forward transfer admittance	$I_D = 4$ mA				
		amplifier A	17	22	32	mS
		amplifier B	17	22	32	mS
$C_{iss(G1)}$	input capacitance at gate1	$I_D = 4$ mA; $f = 100$ MHz				
		amplifier A	-	2.4	2.9	pF
		amplifier B	-	1.7	2.2	pF
NF	noise figure	$I_D = 4$ mA				
		amplifier A; $f = 400$ MHz	-	1.0	1.6	dB
		amplifier B; $f = 800$ MHz	-	1.0	1.6	dB
Xmod	cross modulation	input level for $k = 1$ % at 40 dB AGC				
		amplifier A	92	97	-	dB $\mu$ V
		amplifier B	93	98	-	dB $\mu$ V

## 2. Pinning information

**Table 2: Discrete pinning**

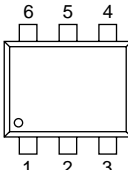
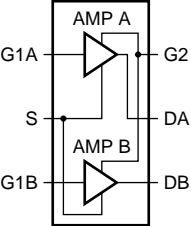
Pin	Description	Simplified outline	Symbol
1	gate1 (AMP A)		
2	source		
3	gate1 (AMP B)		
4	drain (AMP B)		
5	drain (AMP A)		
6	gate2		

*sym111*

## 3. Ordering information

**Table 3: Ordering information**

Type number	Package		Version
	Name	Description	
BF1206F	-	plastic surface mounted package; 6 leads	SOT666

## 4. Marking

Table 4: Marking

Type number	Marking code
BF1206F	2N

## 5. Limiting values

Table 5: Limiting values

In accordance with the Absolute Maximum Rating System (IEC 60134).

Symbol	Parameter	Conditions	Min	Max	Unit
<b>Per MOSFET</b>					
$V_{DS}$	drain-source voltage (DC)		-	6	V
$I_D$	drain current (DC)		-	30	mA
$I_{G1}$	gate1 current		-	$\pm 10$	mA
$I_{G2}$	gate2 current		-	$\pm 10$	mA
$P_{tot}$	total power dissipation	$T_{sp} \leq 107\text{ °C}$ [1]	-	180	mW
$T_{stg}$	storage temperature		-65	+150	°C
$T_j$	junction temperature		-	150	°C

[1]  $T_{sp}$  is the temperature at the solder point of the source lead.

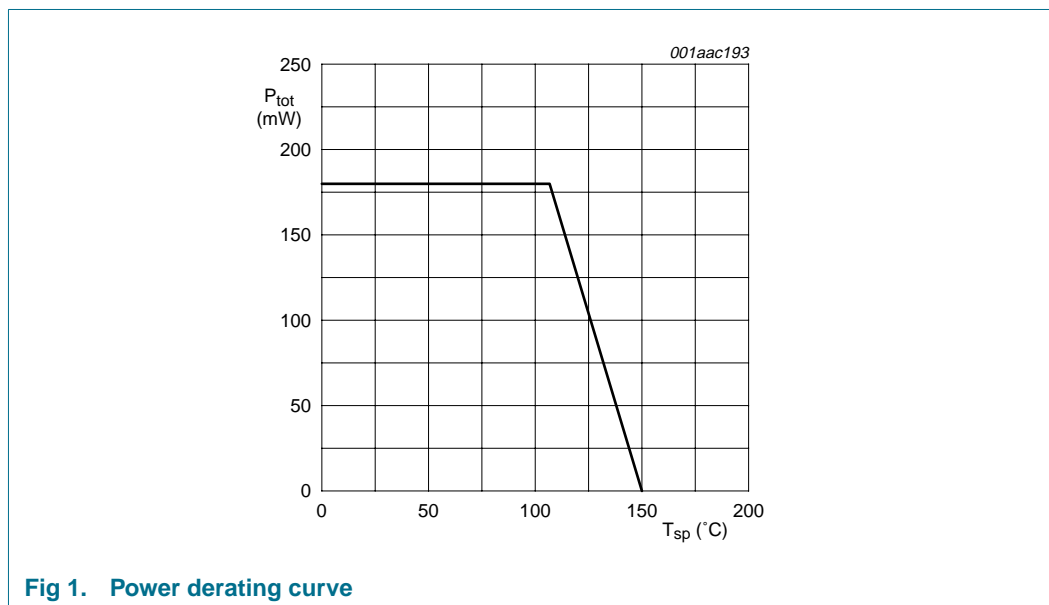

Fig 1. Power derating curve

## 6. Thermal characteristics

Table 6: Thermal characteristics

Symbol	Parameter	Conditions	Typ	Unit
$R_{th(j-sp)}$	thermal resistance from junction to solder point		240	K/W

## 7. Static characteristics

**Table 7: Static characteristics**
 $T_j = 25\text{ }^\circ\text{C}$ 

Symbol	Parameter	Conditions	Min	Typ	Max	Unit
<b>Per MOSFET; unless otherwise specified</b>						
$V_{(BR)DSS}$	drain-source breakdown voltage	$V_{G1-S} = V_{G2-S} = 0\text{ V}$ ; $I_D = 10\text{ }\mu\text{A}$				
		amplifier A	6	-	-	V
		amplifier B	6	-	-	V
$V_{(BR)G1-SS}$	gate1-source breakdown voltage	$V_{GS} = V_{DS} = 0\text{ V}$ ; $I_{G1-S} = 10\text{ mA}$	6	-	10	V
$V_{(BR)G2-SS}$	gate2-source breakdown voltage	$V_{GS} = V_{DS} = 0\text{ V}$ ; $I_{G2-S} = 10\text{ mA}$	6	-	10	V
$V_{F(S-G1)}$	forward source-gate1 voltage	$V_{G2-S} = V_{DS} = 0\text{ V}$ ; $I_{S-G1} = 10\text{ mA}$	0.5	-	1.5	V
$V_{F(S-G2)}$	forward source-gate2 voltage	$V_{G1-S} = V_{DS} = 0\text{ V}$ ; $I_{S-G2} = 10\text{ mA}$	0.5	-	1.5	V
$V_{G1-S(th)}$	gate1-source threshold voltage	$V_{DS} = 5\text{ V}$ ; $V_{G2-S} = 4\text{ V}$ ; $I_D = 100\text{ }\mu\text{A}$	0.3	-	1.0	V
$V_{G2-S(th)}$	gate2-source threshold voltage	$V_{DS} = 5\text{ V}$ ; $V_{G1-S} = 5\text{ V}$ ; $I_D = 100\text{ }\mu\text{A}$	0.35	-	1.0	V
$I_{DSX}$	drain cut-off current	$V_{G2-S} = 2.5\text{ V}$ ; $V_{DS} = 2.8\text{ V}$	[1]			
		amplifier A; $R_{G1} = 270\text{ k}\Omega$	3	-	6.5	mA
		amplifier B; $R_{G1} = 220\text{ k}\Omega$	3	-	6.5	mA
$I_{G1-S}$	gate1 cut-off current	$V_{G1-S} = 5\text{ V}$ ; $V_{G2-S} = V_{DS} = 0\text{ V}$				
		amplifier A	-	-	50	nA
		amplifier B	-	-	50	nA
$I_{G2-S}$	gate2 cut-off current	$V_{G2-S} = 5\text{ V}$ ; $V_{G1-S} = V_{DS} = 0\text{ V}$ ;	-	-	20	nA

[1]  $R_{G1}$  connects gate 1 to  $V_{GG} = 2.8\text{ V}$ .

## 8. Dynamic characteristics

### 8.1 Dynamic characteristics for amplifier A

**Table 8: Dynamic characteristics for amplifier A**

Common source;  $T_{amb} = 25\text{ }^\circ\text{C}$ ;  $V_{G2-S} = 2.5\text{ V}$ ;  $V_{DS} = 2.8\text{ V}$ ;  $I_D = 4\text{ mA}$ .

Symbol	Parameter	Conditions	Min	Typ	Max	Unit
$ y_{fs} $	forward transfer admittance	$T_j = 25\text{ }^\circ\text{C}$	17	22	32	mS
$C_{iss(G1)}$	input capacitance at gate1	$f = 100\text{ MHz}$	[1]	-	2.4	2.9 pF
$C_{iss(G2)}$	input capacitance at gate2	$f = 100\text{ MHz}$	[1]	-	3.2	pF
$C_{oss}$	output capacitance	$f = 100\text{ MHz}$	[1]	-	1.1	pF
$C_{rss}$	reverse transfer capacitance	$f = 100\text{ MHz}$	[1]	-	15	30 fF
$G_{tr}$	transducer power gain	$B_S = B_{S(opt)}$ ; $B_L = B_{L(opt)}$	[1]			
		$f = 200\text{ MHz}$ ; $G_S = 2\text{ mS}$ ; $G_L = 0.5\text{ mS}$	-	31	-	dB
		$f = 400\text{ MHz}$ ; $G_S = 2\text{ mS}$ ; $G_L = 1\text{ mS}$	-	28	-	dB
		$f = 800\text{ MHz}$ ; $G_S = 3.3\text{ mS}$ ; $G_L = 1\text{ mS}$	-	23	-	dB
NF	noise figure	$f = 11\text{ MHz}$ ; $G_S = 20\text{ mS}$ ; $B_S = 0$	-	3.5	-	dB
		$f = 400\text{ MHz}$ ; $Y_S = Y_{S(opt)}$	-	1.0	1.6	dB
		$f = 800\text{ MHz}$ ; $Y_S = Y_{S(opt)}$	-	1.1	1.7	dB

**Table 8: Dynamic characteristics for amplifier A ...continued**Common source;  $T_{amb} = 25\text{ }^{\circ}\text{C}$ ;  $V_{G2-S} = 2.5\text{ V}$ ;  $V_{DS} = 2.8\text{ V}$ ;  $I_D = 4\text{ mA}$ .

Symbol	Parameter	Conditions	Min	Typ	Max	Unit
Xmod	cross modulation	input level for $k = 1\%$ ; $f_w = 50\text{ MHz}$ ; $f_{unw} = 60\text{ MHz}$	[2]			
		at 0 dB AGC	88	-	-	dB $\mu$ V
		at 10 dB AGC	-	85	-	dB $\mu$ V
		at 40 dB AGC	92	97	-	dB $\mu$ V

[1] Calculated from measured S-parameters.

[2] Measured in [Figure 32](#) test circuit.

### 8.1.1 Graphs for amplifier A

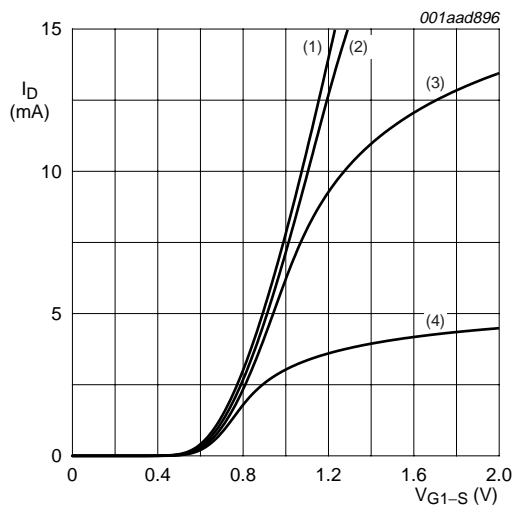

- (1)  $V_{G2-S} = 2.5\text{ V}$ .  
 (2)  $V_{G2-S} = 2.0\text{ V}$ .  
 (3)  $V_{G2-S} = 1.5\text{ V}$ .  
 (4)  $V_{G2-S} = 1.0\text{ V}$ .  
 $V_{DS(A)} = 2.8\text{ V}$ ;  $T_j = 25\text{ }^{\circ}\text{C}$ .

**Fig 2. Amplifier A: transfer characteristics; typical values**

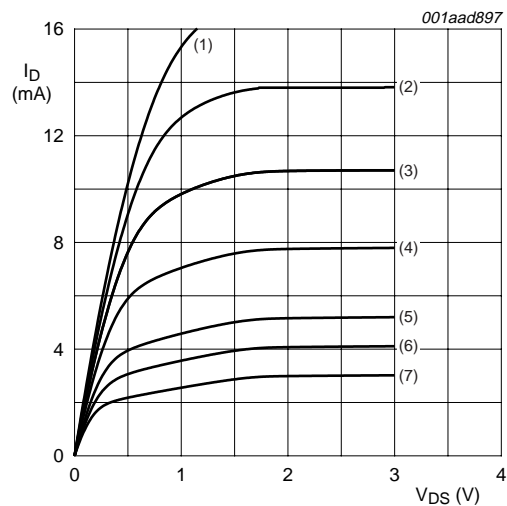

- (1)  $V_{G1-S(A)} = 1.4\text{ V}$ .  
 (2)  $V_{G1-S(A)} = 1.3\text{ V}$ .  
 (3)  $V_{G1-S(A)} = 1.2\text{ V}$ .  
 (4)  $V_{G1-S(A)} = 1.0\text{ V}$ .  
 (5)  $V_{G1-S(A)} = 0.9\text{ V}$ .  
 (6)  $V_{G1-S(A)} = 0.85\text{ V}$ .  
 (7)  $V_{G1-S(A)} = 0.8\text{ V}$ .  
 $V_{G2-S} = 2.5\text{ V}$ ;  $T_j = 25\text{ }^{\circ}\text{C}$ .

**Fig 3. Amplifier A: output characteristics; typical values**

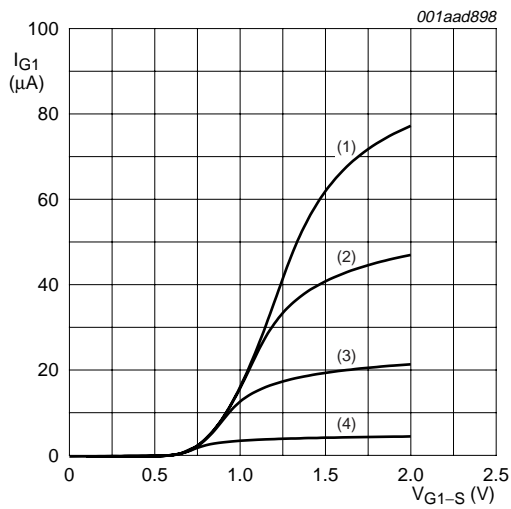

- (1)  $V_{G2-S} = 2.5$  V.  
 (2)  $V_{G2-S} = 2.0$  V.  
 (3)  $V_{G2-S} = 1.5$  V.  
 (4)  $V_{G2-S} = 1.0$  V.  
 $V_{DS(A)} = 2.8$  V;  $T_j = 25$  °C.

**Fig 4. Amplifier A: gate1 current as a function of gate1 voltage; typical values**

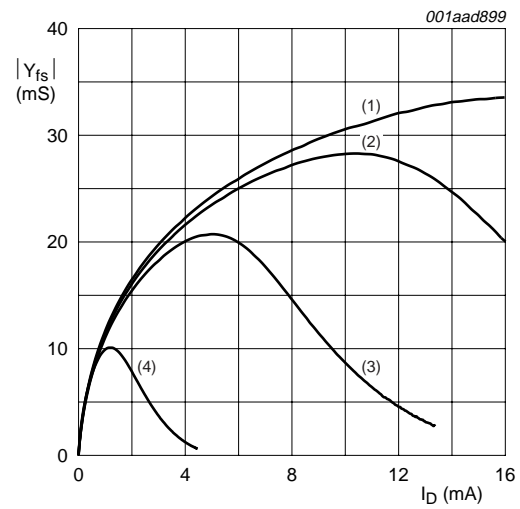

- (1)  $V_{G2-S} = 2.5$  V.  
 (2)  $V_{G2-S} = 2.0$  V.  
 (3)  $V_{G2-S} = 1.5$  V.  
 (4)  $V_{G2-S} = 1.0$  V.  
 $V_{DS(A)} = 2.8$  V;  $T_j = 25$  °C.

**Fig 5. Amplifier A: forward transfer admittance as a function of drain current; typical values**

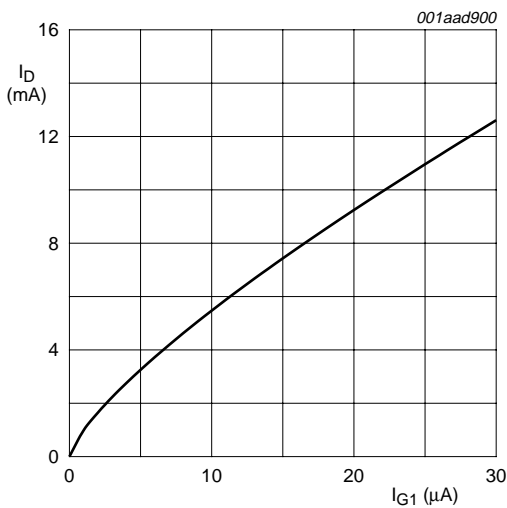

$V_{DS(A)} = 2.8$  V;  $V_{G2-S} = 2.5$  V,  $T_{amb} = 25$  °C.

**Fig 6. Amplifier A: drain current as a function of gate1 current; typical values**

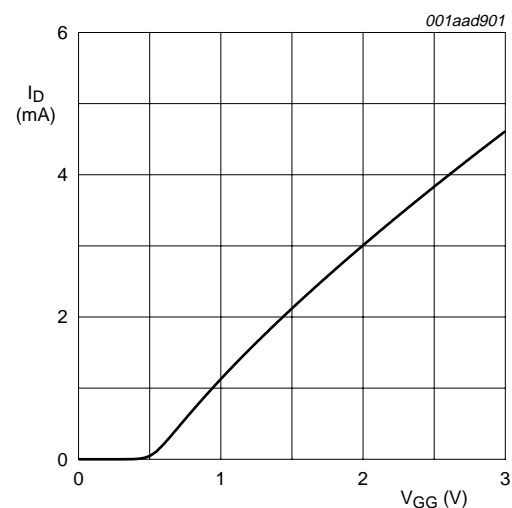

$V_{DS(A)} = 2.8$  V;  $V_{G2} = 2.5$  V;  $R_{G1(A)} = 270$  kΩ; see [Figure 32](#).

**Fig 7. Amplifier A: drain current as a function of gate1 supply voltage (=VGG); typical values**

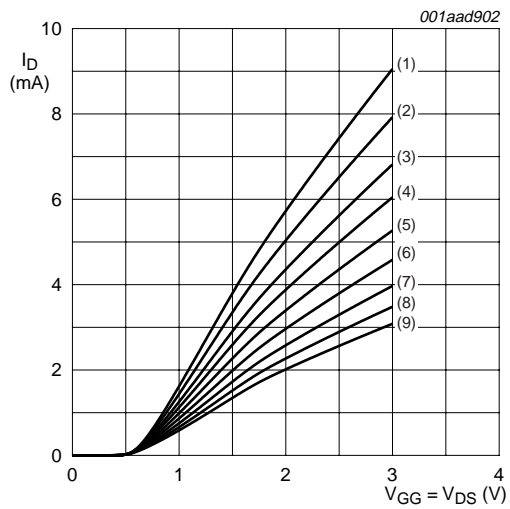

- (1)  $R_{G1} = 100 \text{ k}\Omega$ .
- (2)  $R_{G1} = 120 \text{ k}\Omega$ .
- (3)  $R_{G1} = 150 \text{ k}\Omega$ .
- (4)  $R_{G1} = 180 \text{ k}\Omega$ .
- (5)  $R_{G1} = 220 \text{ k}\Omega$ .
- (6)  $R_{G1} = 270 \text{ k}\Omega$ .
- (7)  $R_{G1} = 330 \text{ k}\Omega$ .
- (8)  $R_{G1} = 390 \text{ k}\Omega$ .
- (9)  $R_{G1} = 470 \text{ k}\Omega$ .

$V_{G2-S} = 2.5 \text{ V}$ ;  $T_j = 25 \text{ }^\circ\text{C}$ ; see [Figure 32](#).

**Fig 8. Amplifier A: drain current as a function of  $V_{DS}$  and  $V_{GG}$ ; typical values**

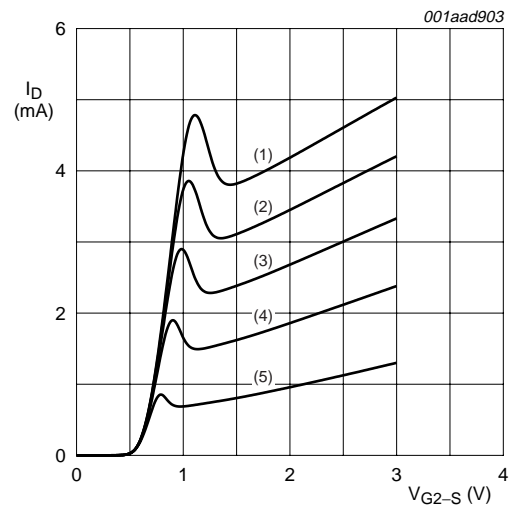

- (1)  $V_{GG} = 1.0 \text{ V}$
- (2)  $V_{GG} = 1.5 \text{ V}$
- (3)  $V_{GG} = 2.0 \text{ V}$
- (4)  $V_{GG} = 2.5 \text{ V}$
- (5)  $V_{GG} = 3.0 \text{ V}$

$T_j = 25 \text{ }^\circ\text{C}$ ;  $R_{G1(A)} = 270 \text{ k}\Omega$  (connected to  $V_{GG}$ ); see [Figure 32](#).

**Fig 9. Amplifier A: drain current as a function of gate2 voltage; typical values**

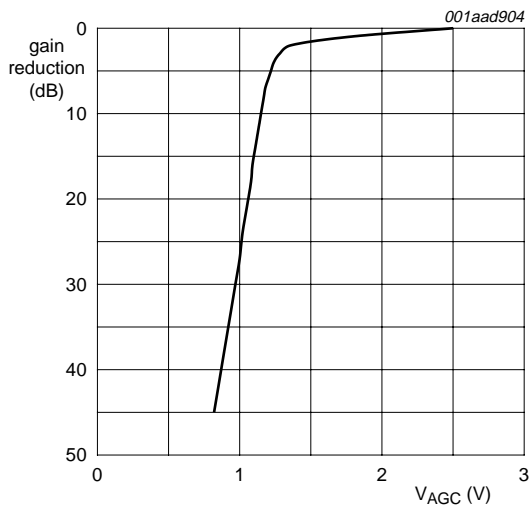

$V_{DS(A)} = 2.8 \text{ V}$ ;  $V_{GG} = 2.8 \text{ V}$ ;  $I_{D(nom)} = 4 \text{ mA}$ ;  
 $T_{amb} = 25 \text{ }^\circ\text{C}$ .

**Fig 10. Amplifier A: typical gain reduction as a function of the AGC voltage; typical values**

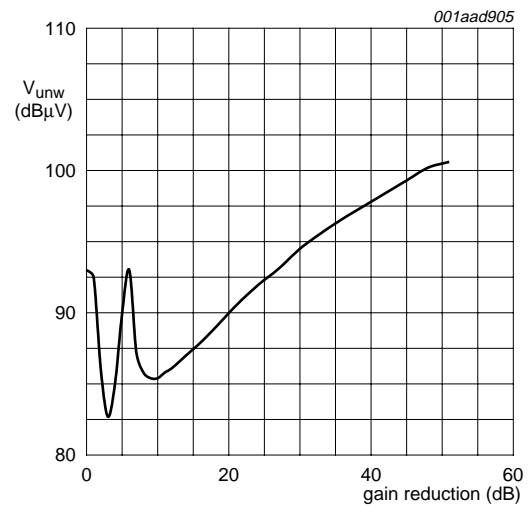

$V_{DS(A)} = 2.8 \text{ V}$ ;  $V_{GG} = 2.8 \text{ V}$ ;  $V_{G2(nom)} = 2.5 \text{ V}$ ;  
 $f_w = 50 \text{ MHz}$ ;  $f_{unw} = 60 \text{ MHz}$ ;  $I_{D(nom)} = 4 \text{ mA}$ ;  
 $T_{amb} = 25 \text{ }^\circ\text{C}$ .

**Fig 11. Amplifier A: unwanted voltage for 1% cross-modulation as a function of gain reduction; typical values**

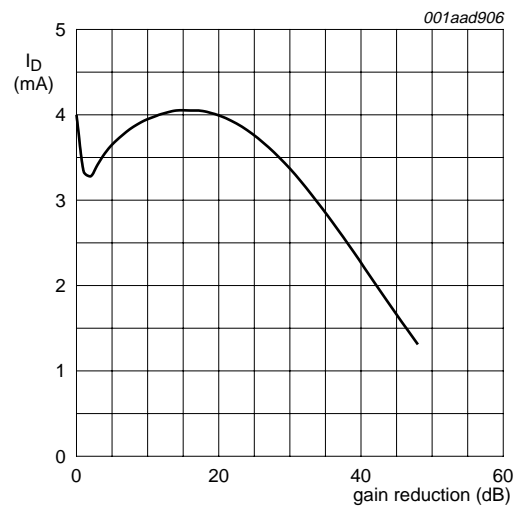

$V_{DS(A)} = 2.8 \text{ V}$ ;  $V_{GG} = 2.8 \text{ V}$ ;  $V_{G2(nom)} = 2.5 \text{ V}$ ;  $R_{G1(A)} = 270 \text{ k}\Omega$ ;  $f = 50 \text{ MHz}$ ;  $T_{amb} = 25 \text{ }^\circ\text{C}$ .

**Fig 12. Amplifier A: typical drain current as a function of gain reduction; typical values**



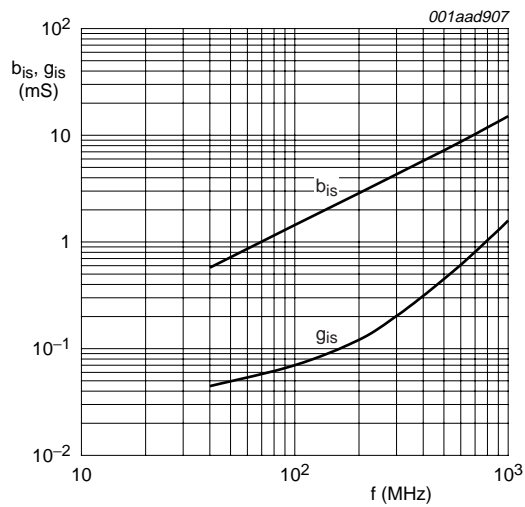

$V_{DS(A)} = 2.8$  V;  $V_{G2-S} = 2.5$  V;  $V_{DS(B)} = 0$  V;  
 $I_{D(A)} = 4$  mA.

**Fig 13. Amplifier A: input admittance and phase as a function of frequency; typical values**

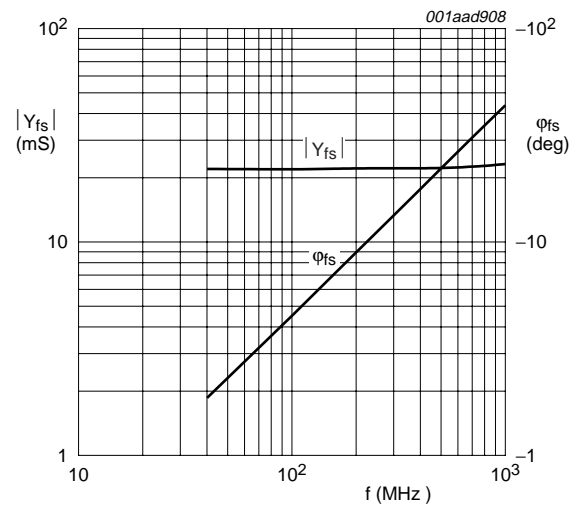

$V_{DS(A)} = 2.8$  V;  $V_{G2-S} = 2.5$  V;  $V_{DS(B)} = 0$  V;  
 $I_{D(A)} = 4$  mA.

**Fig 14. Amplifier A: forward transfer admittance and phase as a function of frequency; typical values**

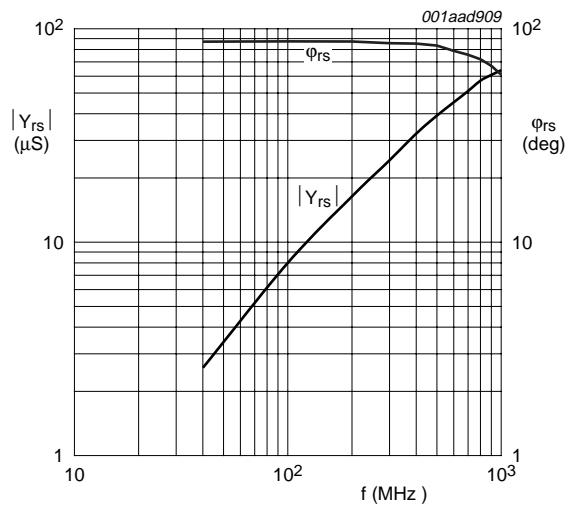

$V_{DS(A)} = 2.8$  V;  $V_{G2-S} = 2.5$  V;  $V_{DS(B)} = 0$  V;  
 $I_{D(A)} = 4$  mA.

**Fig 15. Amplifier A: reverse transfer admittance and phase as a function of frequency: typical values**

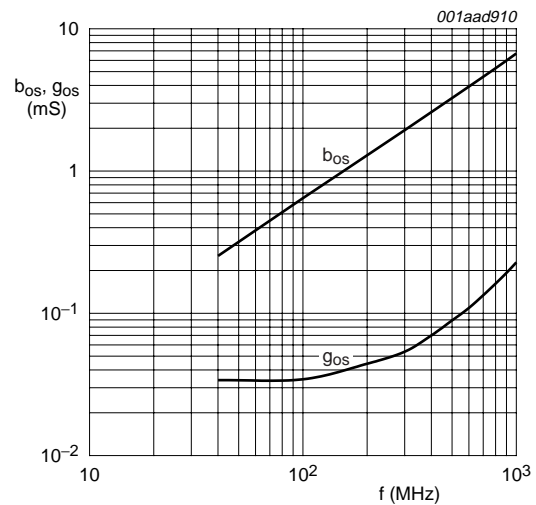

$V_{DS(A)} = 2.8$  V;  $V_{G2-S} = 2.5$  V;  $V_{DS(B)} = 0$  V;  
 $I_{D(A)} = 4$  mA.

**Fig 16. Amplifier A: output admittance and phase as a function of frequency; typical values**

### 8.1.2 Scattering parameters for amplifier A

**Table 9: Scattering parameters for amplifier A**

$V_{DS(A)} = 2.8\text{ V}$ ;  $V_{G2-S} = 2.5\text{ V}$ ;  $I_{D(A)} = 4\text{ mA}$ ;  $V_{DS(B)} = 0\text{ V}$ ;  $V_{G1-S(B)} = 0\text{ V}$ ;  $T_{amb} = 25\text{ °C}$ ; typical values.

f (MHz)	S <sub>11</sub>		S <sub>21</sub>		S <sub>12</sub>		S <sub>22</sub>	
	Magnitude (ratio)	Angle (deg)	Magnitude (ratio)	Angle (deg)	Magnitude (ratio)	Angle (deg)	Magnitude (ratio)	Angle (deg)
50	0.9923	-4.11	2.18	174.68	0.00038	102.27	0.995	-1.83
100	0.9930	-8.29	2.18	169.51	0.00080	85.65	0.996	-3.75
200	0.9877	-16.41	2.16	159.20	0.00161	80.93	0.995	-7.49
300	0.9802	-24.48	2.12	149.04	0.00233	76.76	0.994	-11.22
400	0.9705	-32.34	2.07	138.99	0.00303	73.21	0.992	-14.96
500	0.9596	-39.91	2.01	129.15	0.00354	69.83	0.989	-18.68
600	0.9483	-47.34	1.94	119.45	0.00394	67.19	0.987	-22.39
700	0.9361	-54.59	1.87	109.95	0.00426	65.26	0.984	-26.11
800	0.9239	-61.64	1.79	100.69	0.00453	63.89	0.981	-29.82
900	0.9129	-68.28	1.72	91.66	0.00457	64.06	0.979	-33.57
1000	0.9018	-74.57	1.64	82.86	0.00456	65.60	0.976	-37.31

### 8.2 Noise data for amplifier A

**Table 10: Noise data for amplifier A**

$V_{DS(A)} = 2.8\text{ V}$ ;  $V_{G2-S} = 2.5\text{ V}$ ;  $I_{D(A)} = 4\text{ mA}$ .

f (MHz)	NF <sub>min</sub> (dB)	Γ <sub>opt</sub>		r <sub>n</sub> (ratio)
		ratio	(deg)	
400	1.0	0.78	26	0.84
800	1.1	0.87	53	0.87

### 8.3 Dynamic characteristics for amplifier B

**Table 11: Dynamic characteristics for amplifier B**

Common source;  $T_{amb} = 25\text{ °C}$ ;  $V_{G2-S} = 2.5\text{ V}$ ;  $V_{DS} = 2.8\text{ V}$ ;  $I_D = 4\text{ mA}$ .

Symbol	Parameter	Conditions	Min	Typ	Max	Unit
y <sub>fs</sub>	forward transfer admittance	T <sub>j</sub> = 25 °C	-	22	-	mS
C <sub>iss(G1)</sub>	input capacitance at gate1	f = 100 MHz	[1]	-	1.7	pF
C <sub>iss(G2)</sub>	input capacitance at gate2	f = 100 MHz	[1]	-	4.0	pF
C <sub>oss</sub>	output capacitance	f = 100 MHz	[1]	-	0.85	pF
C <sub>rss</sub>	reverse transfer capacitance	f = 100 MHz	[1]	-	30	fF
G <sub>tr</sub>	transducer power gain	B <sub>S</sub> = B <sub>S(opt)</sub> ; B <sub>L</sub> = B <sub>L(opt)</sub>	[1]			
		f = 200 MHz; G <sub>S</sub> = 2 mS; G <sub>L</sub> = 0.5 mS	-	32	-	dB
		f = 400 MHz; G <sub>S</sub> = 2 mS; G <sub>L</sub> = 1 mS	-	29	-	dB
		f = 800 MHz; G <sub>S</sub> = 3.3 mS; G <sub>L</sub> = 1 mS	-	25	-	dB
NF	noise figure	f = 11 MHz; G <sub>S</sub> = 20 mS; B <sub>S</sub> = 0	-	4.5	-	dB
		f = 400 MHz; Y <sub>S</sub> = Y <sub>S(opt)</sub>	-	0.9	1.5	dB
		f = 800 MHz; Y <sub>S</sub> = Y <sub>S(opt)</sub>	-	1.0	1.6	dB

**Table 11: Dynamic characteristics for amplifier B ...continued**Common source;  $T_{amb} = 25\text{ }^{\circ}\text{C}$ ;  $V_{G2-S} = 2.5\text{ V}$ ;  $V_{DS} = 2.8\text{ V}$ ;  $I_D = 4\text{ mA}$ .

Symbol	Parameter	Conditions	Min	Typ	Max	Unit
Xmod	cross modulation	input level for $k = 1\%$ ; $f_w = 50\text{ MHz}$ ; $f_{unw} = 60\text{ MHz}$ [2]				
		at 0 dB AGC	89	-	-	dB $\mu$ V
		at 10 dB AGC	-	85	-	dB $\mu$ V
		at 40 dB AGC	93	98	-	dB $\mu$ V

[1] Calculated from measured S-parameters.

[2] Measured in [Figure 32](#) test circuit.

### 8.3.1 Graphs for amplifier B

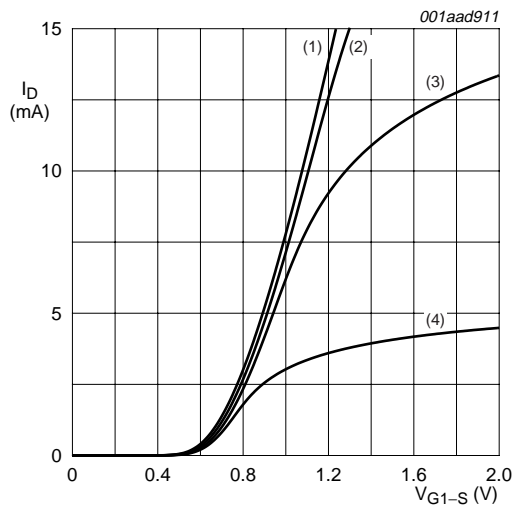

- (1)  $V_{G2-S} = 2.5\text{ V}$ .  
 (2)  $V_{G2-S} = 2.0\text{ V}$ .  
 (3)  $V_{G2-S} = 1.5\text{ V}$ .  
 (4)  $V_{G2-S} = 1.0\text{ V}$ .  
 $V_{DS(B)} = 2.8\text{ V}$ ;  $T_j = 25\text{ }^{\circ}\text{C}$ .

**Fig 17. Amplifier B: transfer characteristics; typical values**

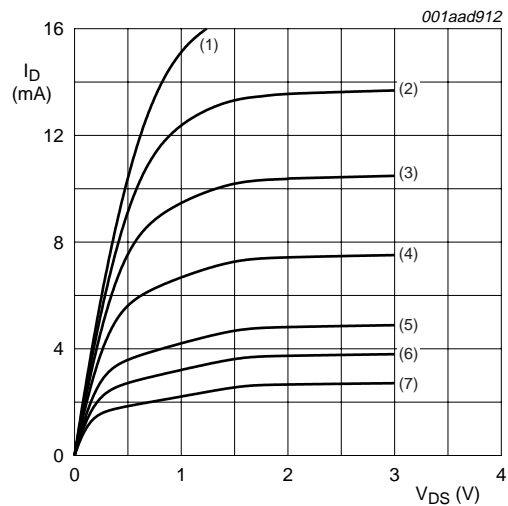

- (1)  $V_{G1-S(B)} = 1.3\text{ V}$ .  
 (2)  $V_{G1-S(B)} = 1.2\text{ V}$ .  
 (3)  $V_{G1-S(B)} = 1.1\text{ V}$ .  
 (4)  $V_{G1-S(B)} = 1.0\text{ V}$ .  
 (5)  $V_{G1-S(B)} = 0.9\text{ V}$ .  
 (6)  $V_{G1-S(B)} = 0.85\text{ V}$ .  
 (7)  $V_{G1-S(B)} = 0.8\text{ V}$ .  
 $V_{G2-S} = 2.5\text{ V}$ ;  $T_j = 25\text{ }^{\circ}\text{C}$ .

**Fig 18. Amplifier B: output characteristics; typical values**

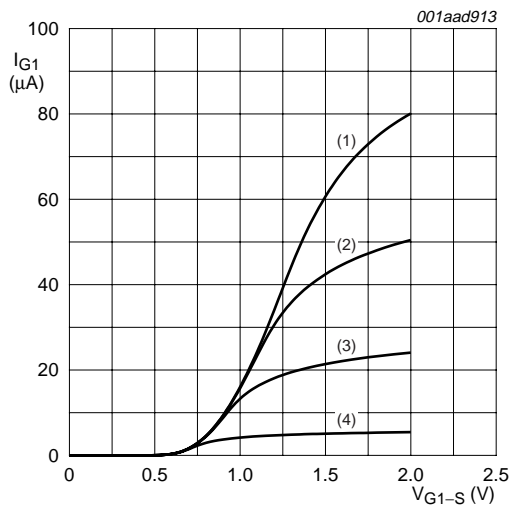

- (1)  $V_{G2-S} = 2.5$  V.  
 (2)  $V_{G2-S} = 2.0$  V.  
 (3)  $V_{G2-S} = 1.5$  V.  
 (4)  $V_{G2-S} = 1.0$  V.  
 $V_{DS(B)} = 2.8$  V;  $T_j = 25$  °C.

**Fig 19. Amplifier B: gate1 current as a function of gate1 voltage; typical values**

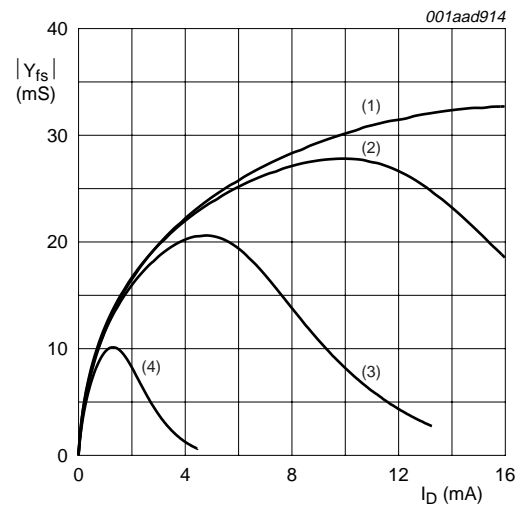

- (1)  $V_{G2-S} = 2.5$  V.  
 (2)  $V_{G2-S} = 2.0$  V.  
 (3)  $V_{G2-S} = 1.5$  V.  
 (4)  $V_{G2-S} = 1.0$  V.  
 $V_{DS(B)} = 2.8$  V;  $T_j = 25$  °C.

**Fig 20. Amplifier B: forward transfer admittance as a function of drain current; typical values**

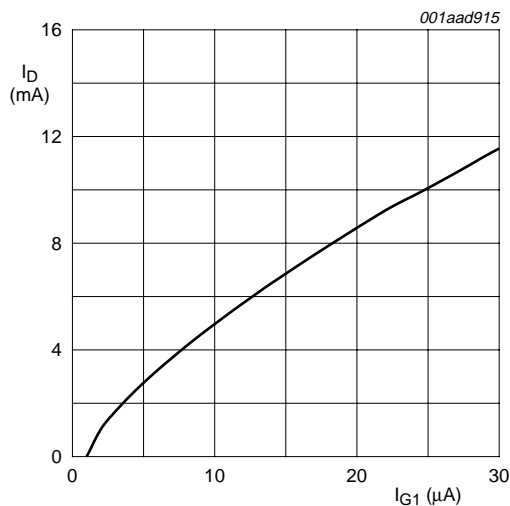

$V_{DS(B)} = 2.8$  V;  $V_{G2-S} = 2.5$  V,  $T_{amb} = 25$  °C.

**Fig 21. Amplifier B: drain current as a function of gate1 current; typical values**

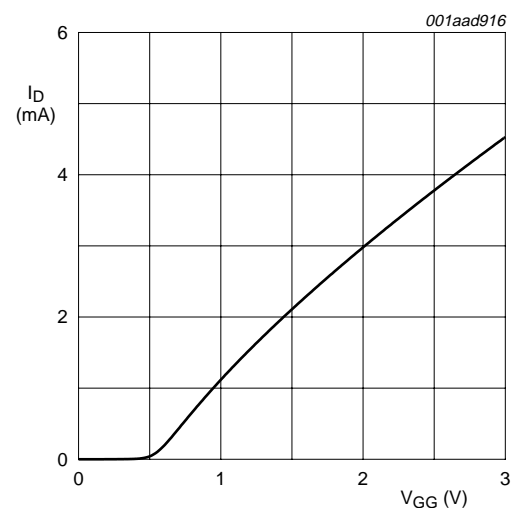

$V_{DS(B)} = 2.8$  V;  $V_{G2-S} = 2.5$  V;  $R_{G1(B)} = 220$  kΩ;  
 see [Figure 32](#).

**Fig 22. Amplifier B: drain current as a function of gate1 supply voltage (=VGG); typical values**

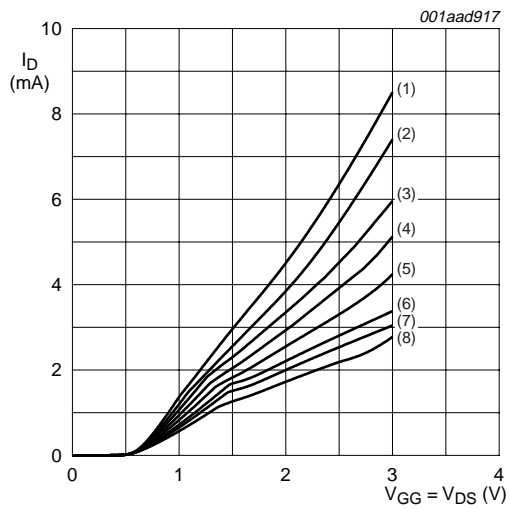

- (1)  $R_{G1} = 120 \text{ k}\Omega$ .
- (2)  $R_{G1} = 150 \text{ k}\Omega$ .
- (3)  $R_{G1} = 180 \text{ k}\Omega$ .
- (4)  $R_{G1} = 220 \text{ k}\Omega$ .
- (5)  $R_{G1} = 270 \text{ k}\Omega$ .
- (6)  $R_{G1} = 330 \text{ k}\Omega$ .
- (7)  $R_{G1} = 390 \text{ k}\Omega$ .
- (8)  $R_{G1} = 470 \text{ k}\Omega$ .

$V_{G2-S} = 2.5 \text{ V}$ ;  $R_{G1(B)}$  connected to  $V_{GG}$ ;  
see [Figure 32](#).

**Fig 23. Amplifier B: drain current as a function of  $V_{DS}$  and  $V_{GG}$ ; typical values**

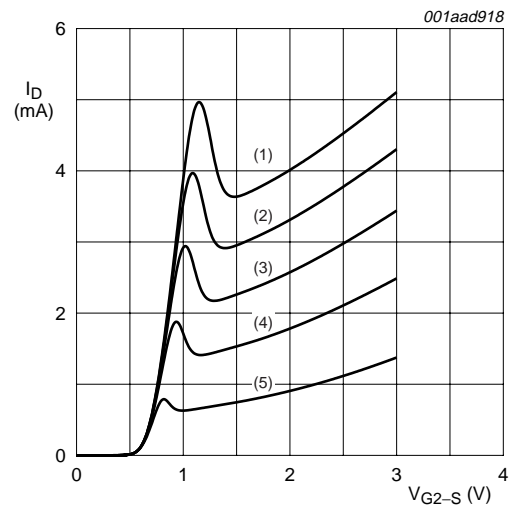

- (1)  $V_{GG} = 3.0 \text{ V}$ .
- (2)  $V_{GG} = 2.5 \text{ V}$ .
- (3)  $V_{GG} = 2.0 \text{ V}$ .
- (4)  $V_{GG} = 1.5 \text{ V}$ .
- (5)  $V_{GG} = 1.0 \text{ V}$ .

$R_{G1(B)} = 220 \text{ k}\Omega$ ;  $T_j = 25 \text{ }^\circ\text{C}$ ; see [Figure 32](#).

**Fig 24. Amplifier B: drain current as a function of gate2 voltage; typical values**

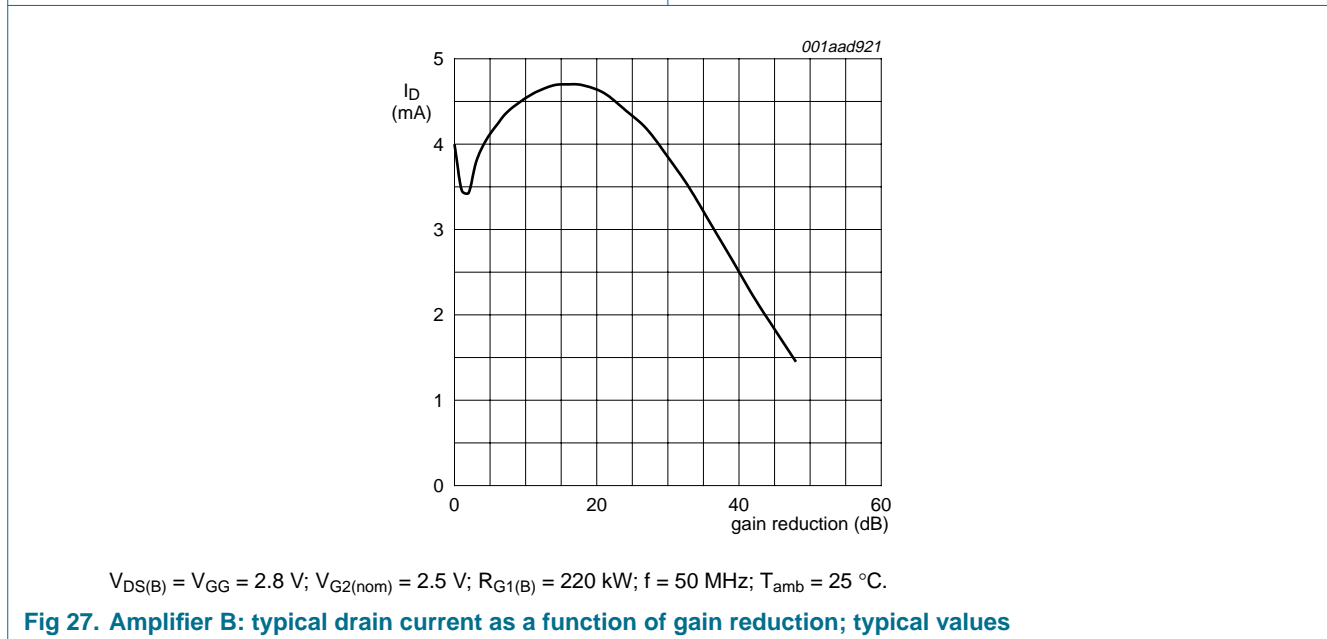
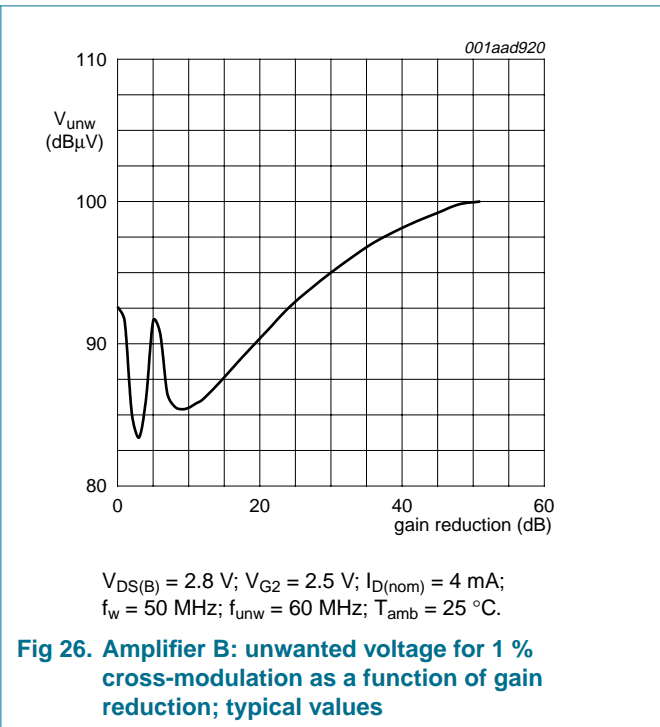
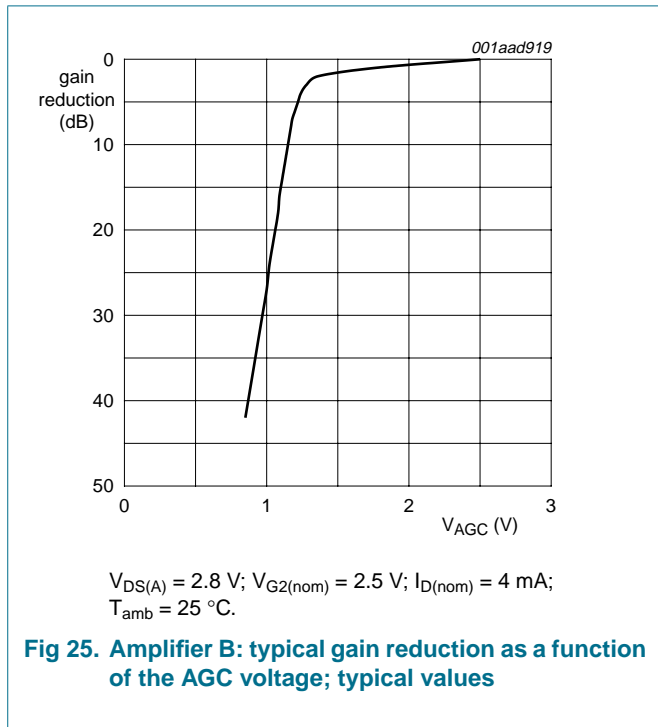

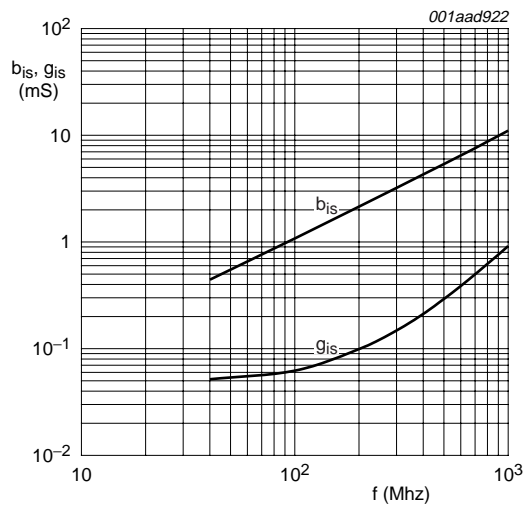

$V_{DS(B)} = 2.8$  V;  $V_{G2-S} = 2.5$  V;  $V_{DS(A)} = 0$  V;  
 $I_{D(B)} = 4$  mA.

**Fig 28. Amplifier B: input admittance and phase as a function of frequency; typical values**

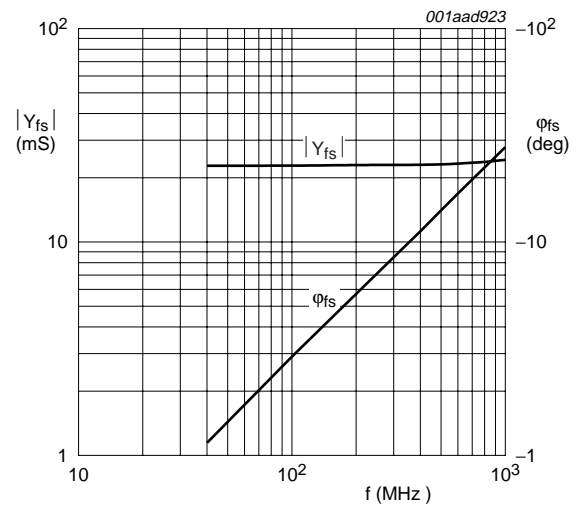

$V_{DS(B)} = 2.8$  V;  $V_{G2-S} = 2.5$  V;  $V_{DS(A)} = 0$  V;  
 $I_{D(B)} = 4$  mA.

**Fig 29. Amplifier B: forward transfer admittance and phase as a function of frequency; typical values**

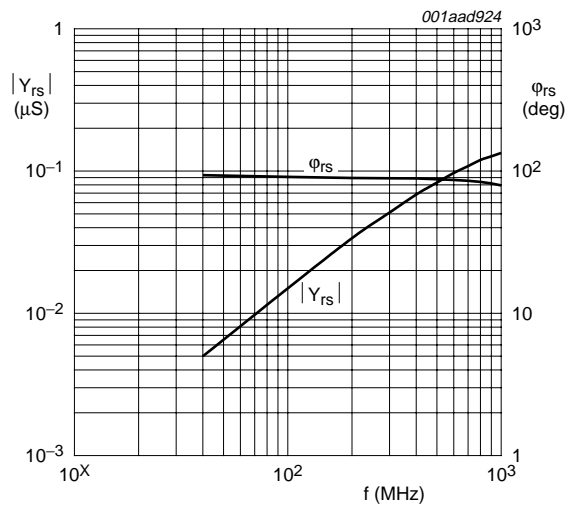

$V_{DS(B)} = 2.8$  V;  $V_{G2-S} = 2.5$  V;  $V_{DS(A)} = 0$  V;  
 $I_{D(B)} = 4$  mA.

**Fig 30. Amplifier B: reverse transfer admittance and phase as a function of frequency; typical values**

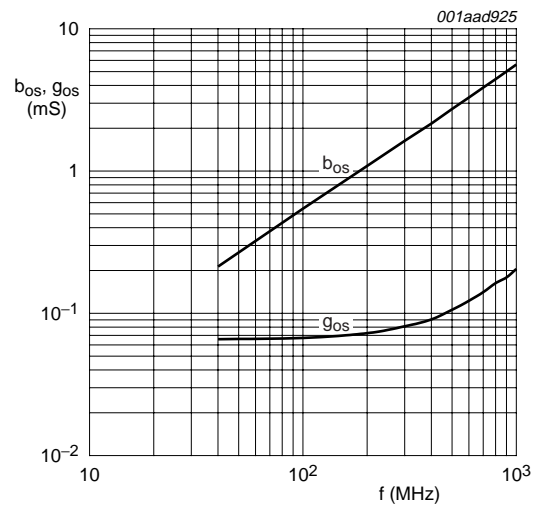

$V_{DS(B)} = 2.8$  V;  $V_{G2-S} = 2.5$  V;  $V_{DS(A)} = 0$  V;  
 $I_{D(B)} = 4$  mA.

**Fig 31. Amplifier B: output admittance and phase as a function of frequency; typical values**

### 8.3.2 Scattering parameters for amplifier B

**Table 12: Scattering parameters for amplifier B**

$V_{DS(B)} = 2.8\text{ V}$ ;  $V_{G2-S} = 2.5\text{ V}$ ;  $I_{D(B)} = 4\text{ mA}$ ;  $V_{DS(A)} = 0\text{ V}$ ;  $V_{G1-S(A)} = 0\text{ V}$ ;  $T_{amb} = 25\text{ }^{\circ}\text{C}$ ; typical values.

f (MHz)	S <sub>11</sub>		S <sub>21</sub>		S <sub>12</sub>		S <sub>22</sub>	
	Magnitude (ratio)	Angle (deg)	Magnitude (ratio)	Angle (deg)	Magnitude (ratio)	Angle (deg)	Magnitude (ratio)	Angle (deg)
50	0.9939	-3.12	2.27	176.11	0.00089	94.68	0.993	-1.62
100	0.9936	-6.29	2.26	172.41	0.00170	84.37	0.993	-3.23
200	0.9896	-12.47	2.25	164.98	0.00336	81.29	0.992	-6.44
300	0.9845	-18.59	2.23	157.64	0.00503	77.17	0.990	-9.65
400	0.9779	-24.66	2.20	150.35	0.00642	73.23	0.988	-12.85
500	0.9703	-30.55	2.16	143.16	0.00769	69.72	0.986	-16.00
600	0.9620	-36.37	2.13	136.02	0.00873	66.28	0.983	-19.18
700	0.9529	-42.10	2.08	129.01	0.00967	63.19	0.980	-22.37
800	0.9439	-47.79	2.04	122.01	0.01024	60.51	0.977	-25.50
900	0.9353	-53.24	1.99	115.30	0.01058	58.52	0.975	-28.66
1000	0.9266	-58.46	1.94	108.64	0.01074	57.24	0.973	-31.85

### 8.3.3 Noise data for amplifier B

**Table 13: Noise data for amplifier B**

$V_{DS(B)} = 2.8\text{ V}$ ;  $V_{G2-S} = 2.5\text{ V}$ ;  $I_{D(B)} = 4\text{ mA}$ .

f (MHz)	NF <sub>min</sub> (dB)	$\Gamma_{opt}$		r <sub>n</sub> (ratio)
		ratio	(deg)	
400	0.9	0.8	19	0.9
800	1.0	0.83	46	0.96

## 9. Test information

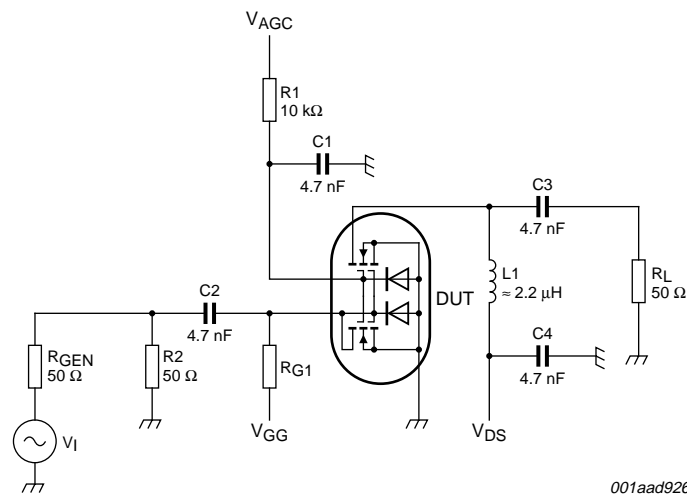

001aad926

**Fig 32. Cross-modulation test setup (for one MOSFET)**



10. Package outline

Plastic surface mounted package; 6 leads

SOT666

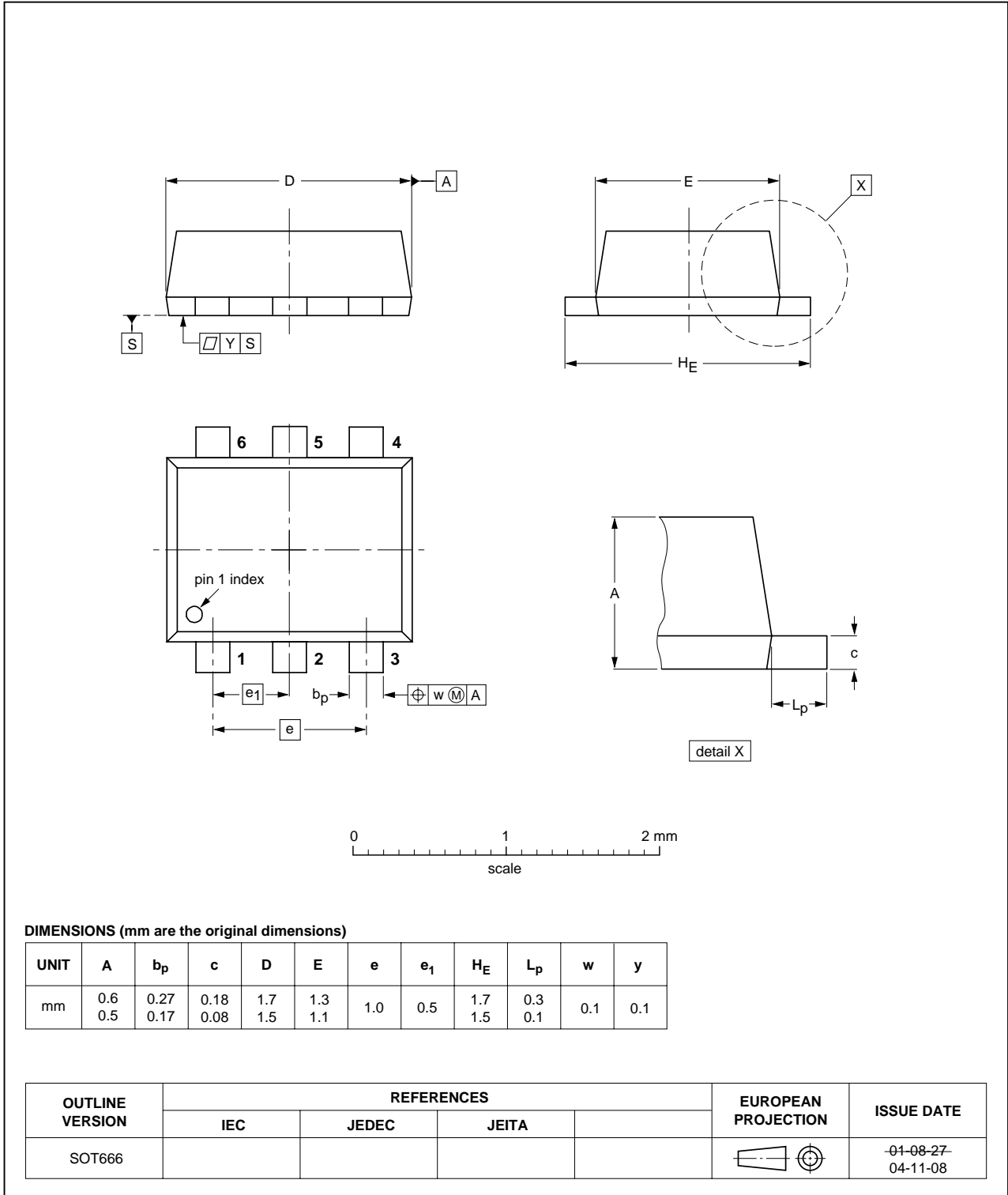

Fig 33. Package outline SOT666

## 11. Revision history

Table 14: Revision history

Document ID	Release date	Data sheet status	Change notice	Doc. number	Supersedes
BF1206F_1	20060130	product data sheet	-	BF1206F_1	-

## 12. Data sheet status

Level	Data sheet status <sup>[1]</sup>	Product status <sup>[2] [3]</sup>	Definition
I	Objective data	Development	This data sheet contains data from the objective specification for product development. Philips Semiconductors reserves the right to change the specification in any manner without notice.
II	Preliminary data	Qualification	This data sheet contains data from the preliminary specification. Supplementary data will be published at a later date. Philips Semiconductors reserves the right to change the specification without notice, in order to improve the design and supply the best possible product.
III	Product data	Production	This data sheet contains data from the product specification. Philips Semiconductors reserves the right to make changes at any time in order to improve the design, manufacturing and supply. Relevant changes will be communicated via a Customer Product/Process Change Notification (CPCN).

[1] Please consult the most recently issued data sheet before initiating or completing a design.

[2] The product status of the device(s) described in this data sheet may have changed since this data sheet was published. The latest information is available on the Internet at URL <http://www.semiconductors.philips.com>.

[3] For data sheets describing multiple type numbers, the highest-level product status determines the data sheet status.

## 13. Definitions

**Short-form specification** — The data in a short-form specification is extracted from a full data sheet with the same type number and title. For detailed information see the relevant data sheet or data handbook.

**Limiting values definition** — Limiting values given are in accordance with the Absolute Maximum Rating System (IEC 60134). Stress above one or more of the limiting values may cause permanent damage to the device. These are stress ratings only and operation of the device at these or at any other conditions above those given in the Characteristics sections of the specification is not implied. Exposure to limiting values for extended periods may affect device reliability.

**Application information** — Applications that are described herein for any of these products are for illustrative purposes only. Philips Semiconductors makes no representation or warranty that such applications will be suitable for the specified use without further testing or modification.

## 14. Disclaimers

**Life support** — These products are not designed for use in life support appliances, devices, or systems where malfunction of these products can reasonably be expected to result in personal injury. Philips Semiconductors

## 16. Contact information

For additional information, please visit: <http://www.semiconductors.philips.com>

For sales office addresses, send an email to: [sales.addresses@www.semiconductors.philips.com](mailto:sales.addresses@www.semiconductors.philips.com)

customers using or selling these products for use in such applications do so at their own risk and agree to fully indemnify Philips Semiconductors for any damages resulting from such application.

**Right to make changes** — Philips Semiconductors reserves the right to make changes in the products - including circuits, standard cells, and/or software - described or contained herein in order to improve design and/or performance. When the product is in full production (status 'Production'), relevant changes will be communicated via a Customer Product/Process Change Notification (CPCN). Philips Semiconductors assumes no responsibility or liability for the use of any of these products, conveys no license or title under any patent, copyright, or mask work right to these products, and makes no representations or warranties that these products are free from patent, copyright, or mask work right infringement, unless otherwise specified.

## 15. Trademarks

**Notice** — All referenced brands, product names, service names and trademarks are the property of their respective owners.

## 17. Contents

<b>1</b>	<b>Product profile</b> . . . . .	<b>1</b>
1.1	General description. . . . .	1
1.2	Features . . . . .	1
1.3	Applications . . . . .	1
1.4	Quick reference data. . . . .	2
<b>2</b>	<b>Pinning information</b> . . . . .	<b>2</b>
<b>3</b>	<b>Ordering information</b> . . . . .	<b>2</b>
<b>4</b>	<b>Marking</b> . . . . .	<b>3</b>
<b>5</b>	<b>Limiting values</b> . . . . .	<b>3</b>
<b>6</b>	<b>Thermal characteristics</b> . . . . .	<b>3</b>
<b>7</b>	<b>Static characteristics</b> . . . . .	<b>4</b>
<b>8</b>	<b>Dynamic characteristics</b> . . . . .	<b>4</b>
8.1	Dynamic characteristics for amplifier A. . . . .	4
8.1.1	Graphs for amplifier A. . . . .	5
8.1.2	Scattering parameters for amplifier A. . . . .	10
8.2	Noise data for amplifier A . . . . .	10
8.3	Dynamic characteristics for amplifier B. . . . .	10
8.3.1	Graphs for amplifier B. . . . .	11
8.3.2	Scattering parameters for amplifier B. . . . .	16
8.3.3	Noise data for amplifier B . . . . .	16
<b>9</b>	<b>Test information</b> . . . . .	<b>16</b>
<b>10</b>	<b>Package outline</b> . . . . .	<b>17</b>
<b>11</b>	<b>Revision history</b> . . . . .	<b>18</b>
<b>12</b>	<b>Data sheet status</b> . . . . .	<b>19</b>
<b>13</b>	<b>Definitions</b> . . . . .	<b>19</b>
<b>14</b>	<b>Disclaimers</b> . . . . .	<b>19</b>
<b>15</b>	<b>Trademarks</b> . . . . .	<b>19</b>
<b>16</b>	<b>Contact information</b> . . . . .	<b>19</b>



© Koninklijke Philips Electronics N.V. 2006

All rights are reserved. Reproduction in whole or in part is prohibited without the prior written consent of the copyright owner. The information presented in this document does not form part of any quotation or contract, is believed to be accurate and reliable and may be changed without notice. No liability will be accepted by the publisher for any consequence of its use. Publication thereof does not convey nor imply any license under patent- or other industrial or intellectual property rights.

Date of release: 30 January 2006  
BF1206F\_1

Published in The Netherlands