

FEATURES

- **SPECIAL PASSIVATED NiCr FILM FOR SUPERIOR ANTI-CORROSION PROPERTIES**
- EIA STANDARD SIZING 0402, 0603, 0805, 1206, 2010 AND 2512
- SUIT FOR HIGH RELIABILITY APPLICATIONS IN HARSH ENVIRONMENTS
- PRECISION TOLERANCE AND TEMPERATURE CHARACTERISTICS
- SAC REFLOW SOLDERABLE (THREE TIMES AT 260°C FOR 32 SECONDS)

RoHS Compliant
includes all homogeneous materials

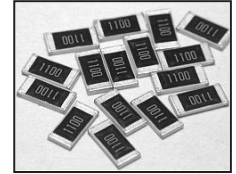

*See Part Number System for Details

SPECIFICATIONS

Type	EIA Size	Power Rating at 70°C	Max. *1 Working Voltage	Max. *2 Overload Voltage	Resistance Tolerance Code	Temperature Coefficient (ppm/°C)	Resistance Range (Ω)	Resistance Values	Operating Temperature Range
NTRC04	0402	0.063W	25V	50V	±0.10% (B) ±0.25% (C) ±0.50% (D)	±25ppm (C) ±50ppm (D)	25Ω ~ 25KΩ	E-24 & E-96	-55°C ~ +155°C
NTRC06	0603	0.063W	50V	100V	±0.10% (B) ±0.25% (C) ±0.50% (D)	±25ppm (C) ±50ppm (D)	25Ω ~ 332KΩ		
NTRC10	0805	0.10W	100V	200V	±0.10% (B) ±0.25% (C) ±0.50% (D)	±25ppm (C) ±50ppm (D)	10Ω ~ 787KΩ		
NTRC12	1206	0.125W	150V	300V	±0.10% (B) ±0.25% (C) ±0.50% (D)	±25ppm (C) ±50ppm (D)	10Ω ~ 1MΩ		
NTRC50	2010	0.25W			±0.10% (B) ±0.25% (C) ±0.50% (D)	±25ppm (C) ±50ppm (D)	10Ω ~ 1MΩ		
NTRC100	2512	0.50W			±0.10% (B) ±0.25% (C) ±0.50% (D)	±25ppm (C) ±50ppm (D)			

Note *1 - Maximum allowable continuous Working Voltage for all resistors is the lower of the two values:

"Maximum Working Voltage" as specified above or the result of the following formula

$$\sqrt{\text{Power rating (Watts)} \times \text{Resistance (Ohms)}}$$

Note *2 - "Maximum Overload Voltage" for all resistors is the lower of the two values:

"Maximum Overload Voltage" as specified above or 2x the result of the following formula

$$\sqrt{\text{Power rating (Watts)} \times \text{Resistance (Ohms)}}$$

Power Derating Curve: For operation above 70°C, power rating must be derated according to the following chart:

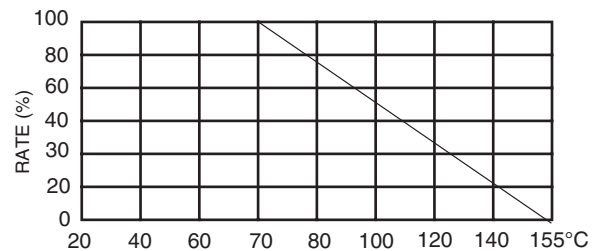

PART NUMBER SYSTEM (E24 & E-96 VALUES)

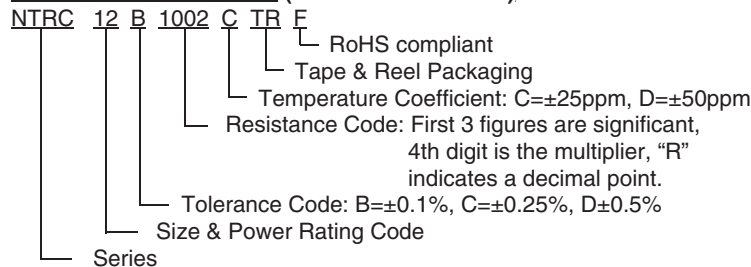

DIMENSIONS (mm)

Type	EIA Size	L	W	H	T	t
NTRC04	0402	1.00 ± 0.05	0.50 ± 0.05	0.30 ± 0.05	0.20 ± 0.10	0.20 ± 0.10
NTRC06	0603	1.55 ± 0.10	0.80 ± 0.10	0.45 ± 0.10	0.30 ± 0.20	0.30 ± 0.20
NTRC10	0805	2.00 ± 0.15	1.25 ± 0.15	0.55 ± 0.10	0.30 ± 0.20	0.40 ± 0.20
NTRC12	1206	3.05 ± 0.15	1.55 ± 0.15	0.55 ± 0.10	0.42 ± 0.20	0.35 ± 0.25
NTRC50	2010	4.90 ± 0.15	2.40 ± 0.15	0.55 ± 0.10	0.60 ± 0.30	0.50 ± 0.25
NTRC100	2512	6.30 ± 0.15	3.10 ± 0.15	0.55 ± 0.10	0.60 ± 0.30	0.50 ± 0.25

CONSTRUCTION

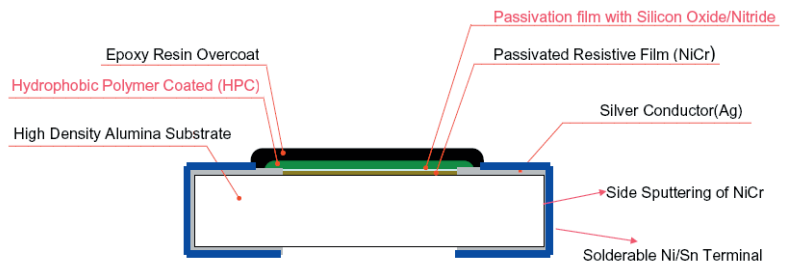
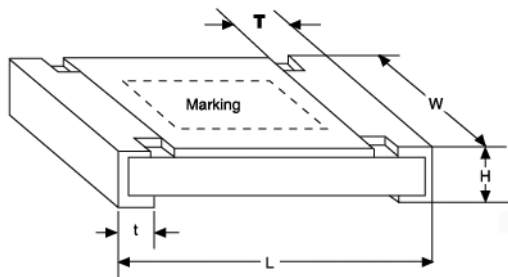

STANDARD E-12, E-24, E-96 VALUES AND 0603 RESISTANCE CODES

E-12		E-24		E-96							
Value		Value		Value	Code	Value	Code	Value	Code	Value	Code
10		100		100	01	102	02	105	03	107	04
12		110		110	05	113	06	115	07	118	08
15		120		121	09	124	10	127	11	130	12
18		130		133	13	137	14	140	15	143	16
22		150		147	17	150	18	154	19	158	20
27		160		162	21	165	22	169	23	174	24
33		180		178	25	182	26	187	27	191	28
39		200		196	29	200	30	205	31	210	32
47		220		215	33	221	34	226	35	232	36
56		240		237	37	243	38	249	39	255	40
68		270		261	41	267	42	274	43	280	44
82		300		287	45	294	46	301	47	309	48
91		330		316	49	324	50	332	51	340	52
		360		348	53	357	54	365	55	374	56
		390		383	57	392	58	402	59	412	60
		430		422	61	432	62	442	63	453	64
		470		464	65	475	66	487	67	499	68
		510		511	69	523	70	536	71	549	72
		560		562	73	576	74	590	75	604	76
		620		619	77	634	78	649	79	665	80
		680		681	81	698	82	715	83	732	84
		750		750	85	768	86	787	87	806	88
		820		825	89	845	90	866	91	887	92
		910		909	93	931	94	953	95	976	96

CARRIER TAPE DIMENSIONS (mm)

Type	EIA Case Size	Carrier Material	A	B	W	F	E	P ₁	P ₂	P ₀	D ₀	t
NTRC04	0402	Paper	0.70 ±0.05	1.16 ±0.10	8.0 ±0.10	3.50 ±0.05	1.75 ±0.05	2.00 ±0.05	n/a	4.00 ±0.10	1.55 ±0.05	0.40 ± 0.03
NTRC06	0603		1.10 ±0.05	1.90 ±0.05				0.60 ± 0.03				
NTRC10	0805		1.60 ±0.05	2.37 ±0.05				0.75 ± 0.03				
NTRC12	1206		2.00 ±0.05	3.50 ±0.05				0.75 ± 0.03				
NTRC50	2010	Embossed Plastic	2.85 ±0.10	5.45 ±0.10	12.0 ±0.10	5.50 ±0.05						1.00 ± 0.20
NTRC100	2512		3.40 ±0.10	6.65 ±0.10								

PAPER CARRIER

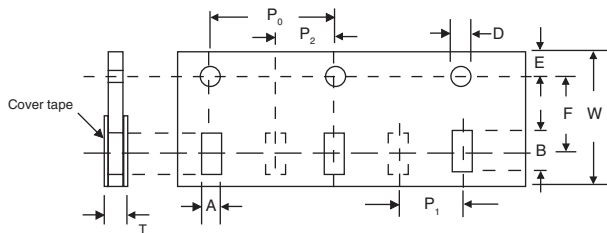

EMBOSED PLASTIC CARRIER

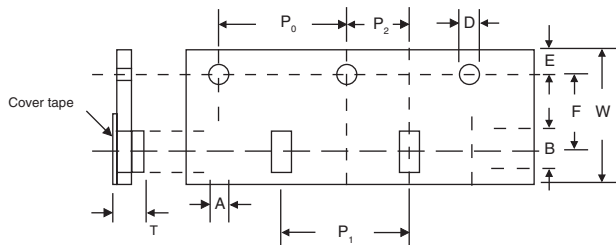

REEL DIMENSIONS (mm)

Type	EIA Case Size	A	B	C	W	Qty
NTRC04	0402	178 ± 1.0	60 ^{+0.50} _{-3.0}	13.0 ± 0.20	9.00 ± 0.50	10,000
NTRC06	0603					5,000
NTRC10	0805				13.0 ± 1.50	4,000
NTRC12	1206					
NTRC50	2010					
NTRC100	2512					

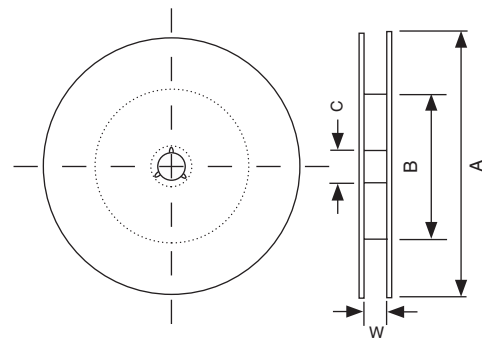

LAND PATTERN DIMENSIONS (mm)

Type	EIA Case Size	A	B	C
NTRC04	0402	0.5	0.5	0.60 ± 0.2
NTRC06	0603	0.8	1.0	0.90 ± 0.2
NTRC10	0805	1.0	1.0	1.35 ± 0.2
NTRC12	1206	2.0	1.15	1.70 ± 0.2
NTRC50	2010	3.6	1.4	2.50 ± 0.2
NTRC100	2512	4.9	1.6	3.10 ± 0.2

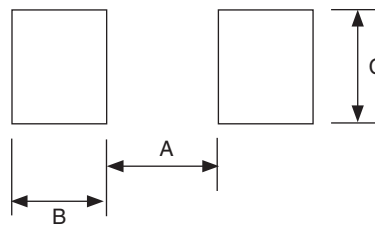

REFLOW SOLDERING TEMPERATURE PROFILE

