

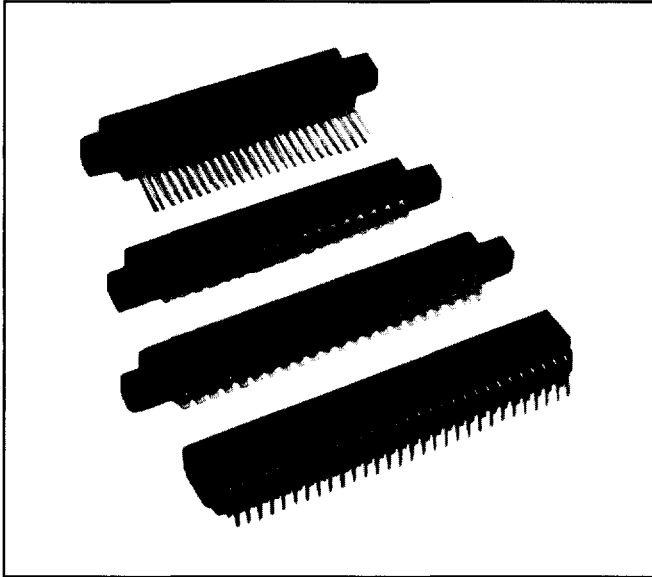

Edgeboard Connectors

150°C and 200°C Burn-In Connectors, Dual Readout



FEATURES

- **EB4**, .100" [2.54mm] C-C. **EB6**, .125" [3.17mm] C-C. **EB7 and EB8**, .156" [3.96mm] C-C.
- Right angle styles included for all models.
- High temperature, glass reinforced phenolic connector bodies - 150°C.
- High temperature, glass reinforced PPS connector bodies - 200°C.
- High reliability copper-nickel-tin alloy contacts.
- Accepts PC board thickness of .054" to .071" [1.37mm to 1.80mm].
- High reliability bifurcated bellows contacts.
- Gold plated contacts.
- Card extender style terminals standard.
- Variety of mounting styles available.
- **Recognized under the Component Program of Underwriters Laboratories, Inc. Listed under File E65524.**

APPLICATIONS

High temperature, long life connectors specifically designed for burn-in oven and automatic temperature testing applications. Available in a wide range of sizes. Priced affordably and competitively.

SPECIAL NOTE:

When operating units at elevated temperatures, solder having a melting point 50 degrees Centigrade above the operating temperature should be used. Contact factory for special solder information.

ELECTRICAL SPECIFICATIONS

- Current Rating:** 5 amps.
- Test Voltage Between Contacts:** At sea level: 1800 V RMS. At 70,000 feet: 450 V RMS.
- Insulation Resistance:** 5000 Megohm minimum at 500 VDC potential.
- Contact Resistance:** 30 millivolts maximum at rated current.
- Humidity:** 48 hours at 95% relative humidity at + 90°C, insulation resistance 5000 Megohm.
- Shock:** Three 50g shocks in each of 3 mutually perpendicular planes with no loss of continuity.

MATERIAL SPECIFICATIONS

- Body Material:** 150°C Connectors: Fiberglass reinforced phenolic, + 150°C operating temperature, flame-retardant (UL 94V-O). 200°C Connectors: Fiberglass reinforced polyethylene sulfide, + 200°C operating temperature, flame retardant (UL 94V-O).
- Contacts:** Copper-nickel-tin alloy per ASTM B 740.
- Plating:** Gold plating (.00003" [.000762mm] thick), over .00005" [.00127mm] minimum nickel underplate.

MOUNTING STYLES [Numbers in brackets indicate millimeters]

Card Extender Mounting For Fast Change of Test Setups

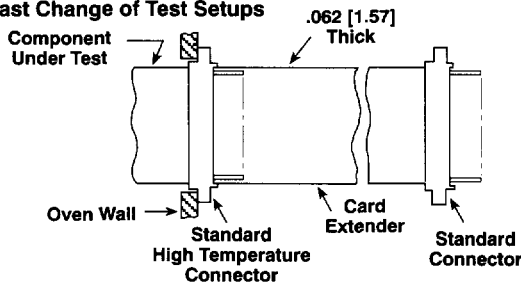

- EB4 .100" [2.54mm] C-C
- EB6 .125" [3.17mm] C-C
- EB7 .156" [3.96mm] C-C
- EB8 .156" [3.96mm] C-C

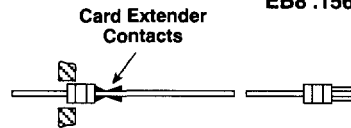

150°C CARD EXTENDER MODEL NUMBERS

200°C CARD EXTENDER MODEL NUMBERS

EB44-PE43GX	EB44-PE12GX	EB64-PE24GX	EB74D-PE36GX
EB44-PE44GX	EB44-PE15GX	EB64-PE25GX	EB74D-PE43GX
EB44-PE48GX	EB44-PE18GX	EB64-PE28GX	EB84-PE6GX
EB44-PE49GX	EB44-PE20GX	EB64-PE30GX	EB84-PE10GX
EB44-PE50GX	EB44-PE22GX	EB64-PE31GX	EB84-PE12GX
EB44-PE60GX	EB44-PE25GX	EB64-PE32GX	EB84-PE15GX
EB44-PE65GX	EB44-PE28GX	EB64-PE35GX	EB84-PE18GX
EB64-PE6GX	EB44-PE30GX	EB64-PE36GX	EB84-PE22GX
EB64-PE10GX	EB44-PE31GX	EB64-PE40GX	EB84-PE24GX
EB64-PE14GX	EB44-PE35GX	EB64-PE43GX	EB84-PE25GX
EB64-PE15GX	EB44-PE36GX	EB64-PE44GX	
EB64-PE18GX	EB44-PE40GX	EB64-PE49GX	
EB44-PE10GX	EB64-PE22GX	EB64-PE50GX	

EB45-PE10GX	EB45-PE43GX	EB65-PE22GX	EB65-PE50GX
EB45-PE12GX	EB45-PE44GX	EB65-PE24GX	EB75D-PE36GX
EB45-PE15GX	EB45-PE48GX	EB65-PE25GX	EB75D-PE43GX
EB44-PE18GX	EB45-PE49GX	EB65-PE28GX	EB85-PE6GX
EB45-PE20GX	EB45-PE50GX	EB65-PE30GX	EB85-PE10GX
EB45-PE22GX	EB45-PE60GX	EB65-PE31GX	EB85-PE12GX
EB45-PE25GX	EB45-PE65GX	EB65-PE32GX	EB85-PE15GX
EB45-PE28GX	EB65-PE6GX	EB65-PE35GX	EB85-PE18GX
EB45-PE30GX	EB65-PE10GX	EB65-PE36GX	EB85-PE22GX
EB45-PE31GX	EB65-PE12GX	EB65-PE40GX	EB85-PE24GX
EB45-PE35GX	EB65-PE14GX	EB65-PE43GX	EB85-PE25GX
EB45-PE36GX	EB65-PE15GX	EB65-PE44GX	
EB45-PE40GX	EB65-PE18GX	EB65-PE49GX	

MOUNTING STYLES [Numbers in brackets indicate millimeters]

Wire Wrap™
Permanent Mounting

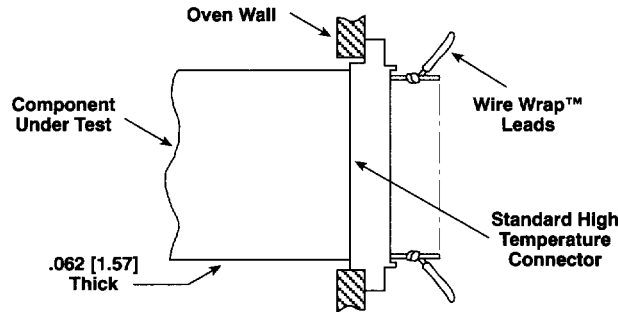

EB4 .100" [2.54mm] C-C
EB6 .125" [3.17mm] C-C

150°C WIRE WRAP™ MODEL NUMBERS

EB44-PK10GX	EB44-PK35GX	EB64-PK6GX	EB64-PK31GX
EB44-PK12GX	EB44-PK36GX	EB64-PK10GX	EB64-PK32GX
EB44-PK15GX	EB44-PK40GX	EB64-PK14GX	EB64-PK35GX
EB44-PK18GX	EB44-PK43GX	EB64-PK15GX	EB64-PK36GX
EB44-PK20GX	EB44-PK44GX	EB64-PK18GX	EB64-PK40GX
EB44-PK22GX	EB44-PK48GX	EB64-PK22GX	EB64-PK43GX
EB44-PK25GX	EB44-PK49GX	EB64-PK24GX	EB64-PK44GX
EB44-PK28GX	EB44-PK50GX	EB64-PK25GX	EB64-PK49GX
EB44-PK30GX	EB44-PK60GX	EB64-PK28GX	EB64-PK50GX
EB44-PK31GX	EB44-PK65GX	EB64-PK30GX	

200°C WIRE WRAP™ MODEL NUMBERS

EB45-PK10GX	EB45-PK35GX	EB65-PK6GX	EB65-PK30GX
EB45-PK12GX	EB45-PK36GX	EB65-PK10GX	EB65-PK31GX
EB45-PK15GX	EB45-PK40GX	EB65-PK12GX	EB65-PK32GX
EB45-PK18GX	EB45-PK43GX	EB65-PK14GX	EB65-PK35GX
EB45-PK20GX	EB45-PK44GX	EB65-PK15GX	EB65-PK36GX
EB45-PK22GX	EB45-PK48GX	EB65-PK18GX	EB65-PK40GX
EB45-PK25GX	EB45-PK49GX	EB65-PK22GX	EB65-PK43GX
EB45-PK28GX	EB45-PK50GX	EB65-PK24GX	EB65-PK44GX
EB45-PK30GX	EB45-PK60GX	EB65-PK25GX	EB65-PK49GX
EB45-PK31GX	EB45-PK65GX	EB65-PK28GX	EB65-PK50GX

Right Angle
PC Board Mounting

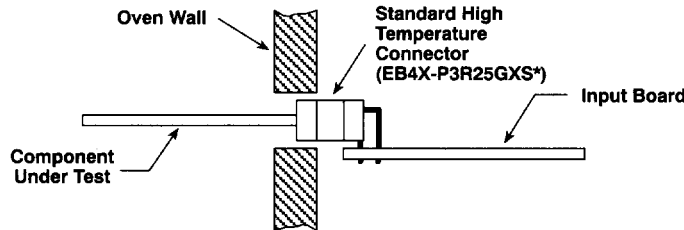

EB4 .100" [2.54mm] C-C
EB6 .125" [3.17mm] C-C
EB7 .156" [3.96mm] C-C

150°C RIGHT ANGLE MODEL NUMBERS

EB44-P3R10GXS	EB44-P3R40GXS	EB64-P3R18GX	EB64-P3R44GX
EB44-P3R12GXS	EB44-P3R43GXS	EB64-P3R22GX	EB64-P3R49GX
EB44-P3R15GXS	EB44-P3R44GXS	EB64-P3R24GX	EB64-P3R50GX
EB44-P3R18GXS	EB44-P3R48GXS	EB64-P3R25GX	EB74D-PR6GXS
EB44-P3R20GXS	EB44-P3R49GXS	EB64-P3R28GX	EB74D-PR10GXS
EB44-P3R22GXS	EB44-P3R50GXS	EB64-P3R30GX	EB74D-PR12GXS
EB44-P3R25GXS*	EB44-P3R60GXS	EB64-P3R31GX	EB74D-PR15GXS
EB44-P3R28GXS	EB44-P3R65GXS	EB64-P3R32GX	EB74D-PR18GXS
EB44-P3R30GXS	EB64-P3R6GX	EB64-P3R35GX	EB74D-PR22GXS
EB44-P3R31GXS	EB64-P3R10GX	EB64-P3R36GX	EB74D-PR36GXS
EB44-P3R35GXS	EB64-P3R14GX	EB64-P3R40GX	EB74D-PR43GXS
EB44-P3R36GXS	EB64-P3R15GX	EB64-P3R43GX	

200°C RIGHT ANGLE MODEL NUMBERS

EB45-P3R10GXS	EB45-P3R40GXS	EB65-P3R15GX	EB65-P3R43GX
EB45-P3R12GXS	EB45-P3R43GXS	EB65-P3R18GX	EB65-P3R44GX
EB45-P3R15GXS	EB45-P3R44GXS	EB65-P3R22GX	EB65-P3R49GX
EB45-P3R18GXS	EB45-P3R48GXS	EB65-P3R24GX	EB65-P3R50GX
EB45-P3R20GXS	EB45-P3R49GXS	EB65-P3R25GX	EB75D-PR6GXS
EB45-P3R22GXS	EB45-P3R50GXS	EB65-P3R28GX	EB75D-PR10GXS
EB45-P3R25GXS*	EB45-P3R60GXS	EB65-P3R30GX	EB75D-PR12GXS
EB45-P3R28GXS	EB45-P3R65GXS	EB65-P3R31GX	EB75D-PR15GXS
EB45-P3R30GXS	EB65-P3R6GX	EB65-P3R32GX	EB75D-PR18GXS
EB45-P3R31GXS	EB65-P3R10GX	EB65-P3R35GX	EB75D-PR22GXS
EB45-P3R35GXS	EB65-P3R12GX	EB65-P3R36GX	EB75D-PR36GXS
EB45-P3R36GXS	EB65-P3R14GX	EB65-P3R40GX	EB75D-PR43GXS

Hard Wire
Permanent Mounting

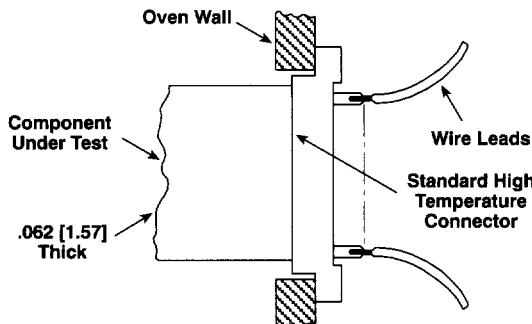

EB7 .156" [3.96mm] C-C
EB8 .156" [3.96mm] C-C

150°C HARD WIRE MODEL NUMBERS

EB84-PA6GX	EB84-PA15GX	EB84-PA24GX	EB74D-PA43GX
EB84-PA10GX	EB84-PA18GX	EB84-PA25GX	
EB84-PA12GX	EB84-PA22GX	EB74D-PA36GX	

200°C HARD WIRE MODEL NUMBERS

EB85-PA6GX	EB85-PA15GX	EB85-PA24GX	EB75D-PA43GX
EB85-PA10GX	EB85-PA18GX	EB85-PA25GX	
EB85-PA12GX	EB85-PA22GX	EB75D-PA36GX	

MOUNTING VARIATIONS [Numbers in brackets indicate millimeters]

EB4 .100" [2.54mm] C-C, EB6 .125" [3.17mm] C-C

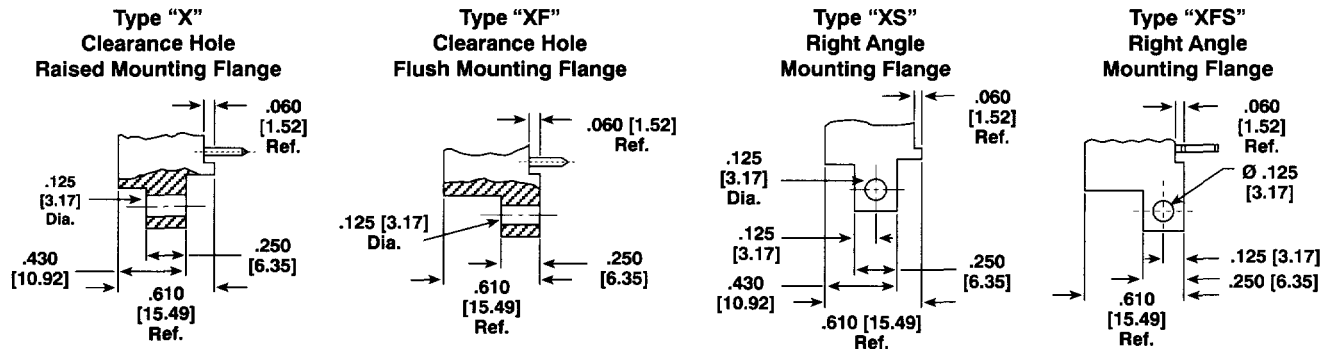

EB7 and EB8 .156" [3.96mm] C-C Side Mounting

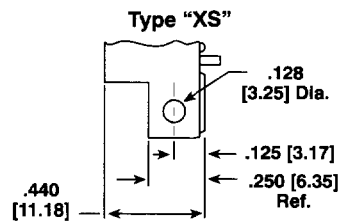

TERMINAL VARIATIONS [Numbers in brackets indicate millimeters]

EB4 .100" [2.54mm] C-C

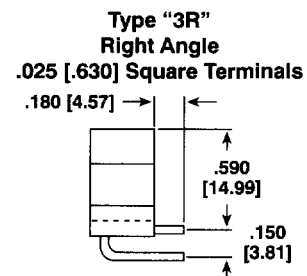
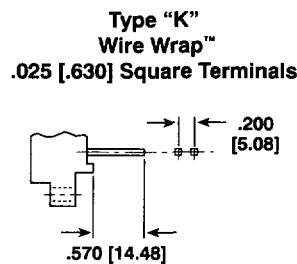
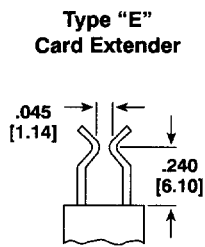

EB6 .125" [3.17mm] C-C

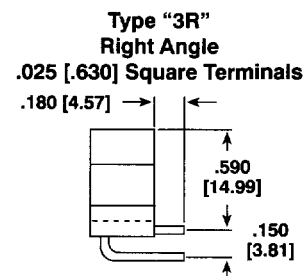
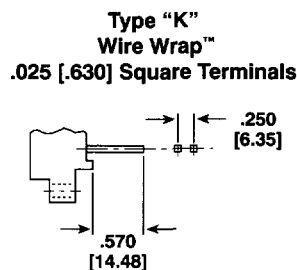
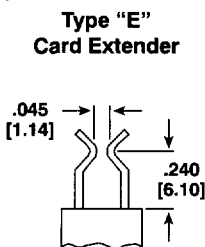

EB7 and EB8 .156" [3.96mm] C-C

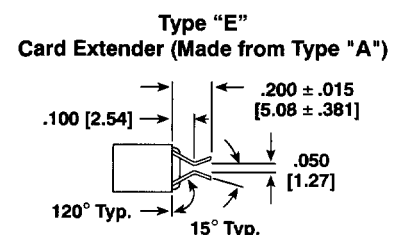
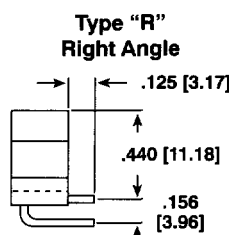
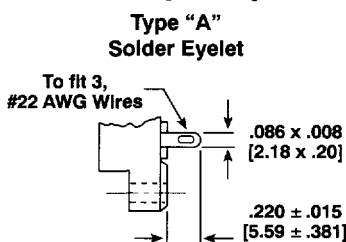

DIMENSIONAL CONFIGURATIONS [Numbers in brackets indicate millimeters]

EB4 .100" [2.54mm] C-C

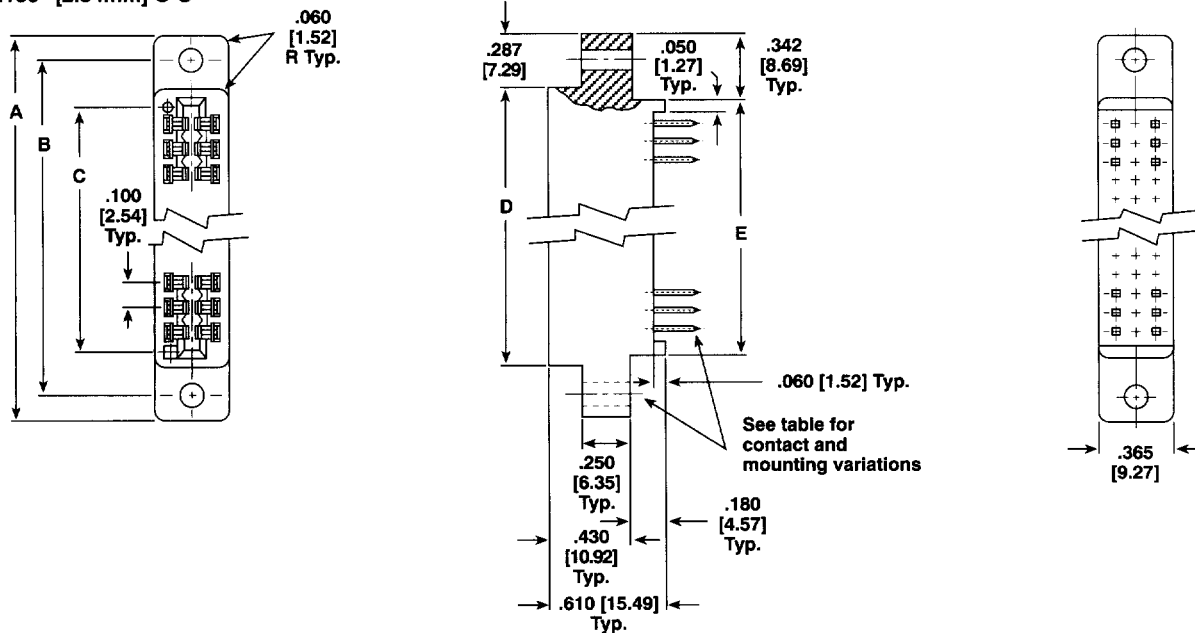

MODEL - PART NUMBER	# OF CONTACT POSITIONS PER SIDE	A	B	C	D	E	CARD SLOT DEPTH
EB4x-P□10GΔ	10	1.835 [46.61]	1.575 [40.00]	1.100 [27.94]	1.260 [32.00]	1.150 [29.21]	.300 [7.62]
EB4x-P□12GΔ	12	2.035 [51.69]	1.775 [45.08]	1.300 [33.02]	1.460 [37.08]	1.350 [34.29]	.300 [7.62]
EB4x-P□15GΔ	15	2.335 [59.31]	2.075 [52.70]	1.600 [40.64]	1.760 [44.70]	1.650 [41.91]	.300 [7.62]
EB4x-P□18GΔ	18	2.635 [66.93]	2.375 [60.32]	1.900 [48.26]	2.060 [52.32]	1.950 [49.53]	.300 [7.62]
EB4x-P□20GΔ	20	2.835 [72.01]	2.575 [65.40]	2.100 [53.34]	2.260 [57.40]	2.150 [54.61]	.300 [7.62]
EB4x-P□22GΔ	22	3.035 [77.09]	2.775 [70.48]	2.300 [58.42]	2.460 [62.48]	2.350 [59.69]	.300 [7.62]
EB4x-P□25GΔ	25	3.335 [84.71]	3.075 [78.10]	2.600 [66.04]	2.760 [70.10]	2.650 [67.31]	.300 [7.62]
EB4x-P□28GΔ	28	3.635 [92.33]	3.375 [85.72]	2.900 [73.66]	3.060 [77.72]	2.950 [74.93]	.300 [7.62]
EB4x-P□30GΔ	30	3.835 [97.41]	3.575 [90.80]	3.100 [78.74]	3.260 [82.80]	3.150 [80.01]	.300 [7.62]
EB4x-P□31GΔ	31	3.935 [99.95]	3.675 [93.34]	3.200 [81.28]	3.360 [85.34]	3.250 [82.55]	.300 [7.62]
EB4x-P□35GΔ	35	4.335 [110.11]	4.075 [103.50]	3.600 [91.44]	3.760 [95.50]	3.650 [92.71]	.300 [7.62]
EB4x-P□36GΔ	36	4.435 [112.65]	4.175 [106.04]	3.700 [93.98]	3.860 [98.04]	3.750 [95.25]	.300 [7.62]
EB4x-P□40GΔ	40	4.835 [122.81]	4.575 [116.20]	4.100 [104.14]	4.260 [108.20]	4.150 [105.41]	.300 [7.62]
EB4x-P□43GΔ	43	5.135 [130.43]	4.875 [123.82]	4.400 [111.76]	4.560 [115.82]	4.450 [113.03]	.300 [7.62]
EB4x-P□44GΔ	44	5.235 [132.97]	4.975 [126.36]	4.500 [114.30]	4.660 [118.36]	4.550 [115.57]	.300 [7.62]
EB4x-P□48GΔ	48	5.635 [143.13]	5.375 [136.52]	4.900 [124.46]	5.060 [128.52]	4.950 [125.73]	.300 [7.62]
EB4x-P□49GΔ	49	5.735 [145.67]	5.475 [139.06]	5.000 [127.00]	5.160 [131.06]	5.050 [128.27]	.300 [7.62]
EB4x-P□50GΔ	50	5.835 [148.21]	5.575 [141.60]	5.100 [129.54]	5.260 [133.60]	5.150 [130.81]	.300 [7.62]
EB4x-P□60GΔ	60	6.835 [173.61]	6.575 [167.00]	6.100 [154.94]	6.260 [159.00]	6.150 [156.21]	.300 [7.62]
EB4x-P□65GΔ	65	7.335 [186.31]	7.075 [179.70]	6.600 [167.64]	6.760 [171.70]	6.650 [168.91]	.300 [7.62]

ORDERING INFORMATION

When ordering connectors using the above Part Numbers:

- x = Indicate "4" for 150°C Burn-In Connectors or "5" for 200°C Burn-In Connectors.
- = Indicate "E" for Card Extender, "K" for Wire Wrap™ or "3R" for Right Angle Terminals.
- Δ = Indicate "X" for Standard Mounting, "XF" for Flush Mounting or "XS" for Side Mounting.

DIMENSIONAL CONFIGURATIONS [Numbers in brackets indicate millimeters]

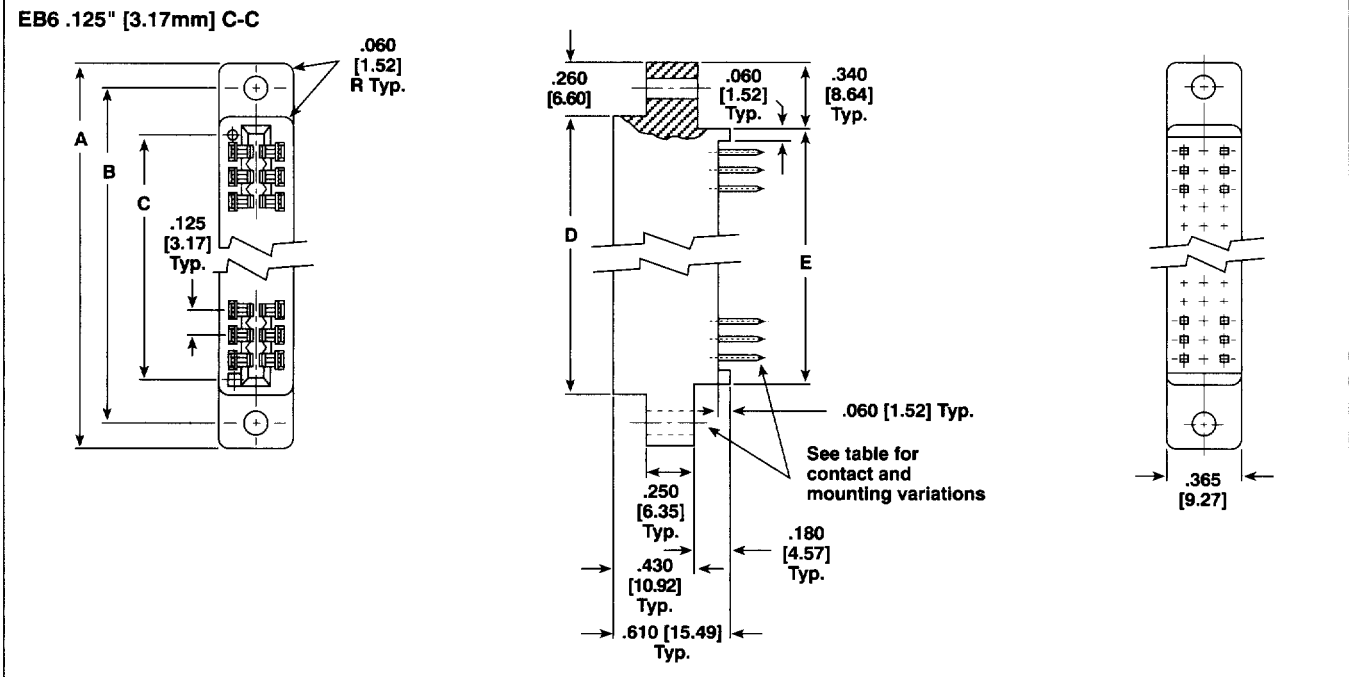

MODEL - PART NUMBER	# OF CONTACT POSITIONS PER SIDE	A	B	C	D	E	CARD SLOT DEPTH
EB6x-P□6GΔ	6	1.555 [39.50]	1.295 [32.89]	.875 [22.22]	1.035 [26.29]	.875 [22.22]	.300 [7.62]
EB6x-P□10GΔ	10	2.055 [52.20]	1.795 [45.59]	1.375 [34.92]	1.535 [38.99]	1.375 [34.92]	.300 [7.62]
EB6x-P□12GΔ	12	2.305 [58.55]	2.045 [51.94]	1.625 [41.28]	1.785 [45.34]	1.625 [41.28]	.300 [7.62]
EB6x-P□14GΔ	14	2.555 [64.90]	2.295 [58.29]	1.875 [47.62]	2.035 [51.69]	1.875 [47.62]	.300 [7.62]
EB6x-P□15GΔ	15	2.680 [68.07]	2.420 [61.47]	2.000 [50.80]	2.160 [54.86]	2.000 [50.80]	.300 [7.62]
EB6x-P□18GΔ	18	3.055 [77.60]	2.795 [70.99]	2.375 [60.32]	2.535 [64.39]	2.375 [60.32]	.300 [7.62]
EB6x-P□22GΔ	22	3.555 [90.30]	3.295 [83.69]	2.875 [73.02]	3.035 [77.09]	2.875 [73.02]	.300 [7.62]
EB6x-P□24GΔ	24	3.805 [96.65]	3.545 [90.04]	3.125 [79.38]	3.285 [83.44]	3.125 [79.38]	.300 [7.62]
EB6x-P□25GΔ	25	3.930 [99.82]	3.670 [93.22]	3.250 [82.55]	3.410 [86.61]	3.250 [82.55]	.300 [7.62]
EB6x-P□28GΔ	28	4.305 [109.35]	4.045 [102.74]	3.625 [92.08]	3.785 [96.14]	3.625 [92.08]	.300 [7.62]
EB6x-P□30GΔ	30	4.555 [115.70]	4.295 [109.09]	3.875 [98.42]	4.035 [102.49]	3.875 [98.42]	.300 [7.62]
EB6x-P□31GΔ	31	4.680 [118.87]	4.420 [112.27]	4.000 [101.60]	4.160 [105.66]	4.000 [101.60]	.300 [7.62]
EB6x-P□32GΔ	32	4.805 [122.05]	4.545 [115.44]	4.125 [104.78]	4.285 [108.84]	4.125 [104.78]	.300 [7.62]
EB6x-P□35GΔ	35	5.180 [131.57]	4.920 [124.97]	4.500 [114.30]	4.660 [118.36]	4.500 [114.30]	.300 [7.62]
EB6x-P□36GΔ	36	5.305 [134.75]	5.045 [128.14]	4.625 [117.48]	4.785 [121.54]	4.625 [117.48]	.300 [7.62]
EB6x-P□40GΔ	40	5.805 [147.45]	5.545 [140.84]	5.125 [130.18]	5.285 [134.24]	5.125 [130.18]	.300 [7.62]
EB6x-P□43GΔ	43	6.180 [156.97]	5.920 [150.37]	5.500 [139.70]	5.660 [143.76]	5.500 [139.70]	.300 [7.62]
EB6x-P□44GΔ	44	6.305 [160.15]	6.045 [153.54]	5.625 [142.88]	5.785 [146.94]	5.625 [142.88]	.300 [7.62]
EB6x-P□49GΔ	49	6.930 [176.02]	6.670 [169.42]	6.250 [158.75]	6.410 [162.81]	6.250 [158.75]	.300 [7.62]
EB6x-P□50GΔ	50	7.055 [179.20]	6.795 [172.59]	6.375 [161.92]	6.535 [165.99]	6.375 [161.92]	.300 [7.62]

ORDERING INFORMATION

When ordering connectors using the above Part Numbers:

- x = Indicate "4" for 150°C Burn-In Connectors or "5" for 200°C Burn-In Connectors.
- = Indicate "E" for Card Extender, "K" for Wire Wrap™ or "3R" for Right Angle Terminals.
- Δ = Indicate "X" for Standard Mounting, "XF" for Flush Mounting or "XS" for Side Mounting.

DIMENSIONAL CONFIGURATIONS [Numbers in brackets indicate millimeters]

EB7 and EB8 .156" [3.96mm] C-C

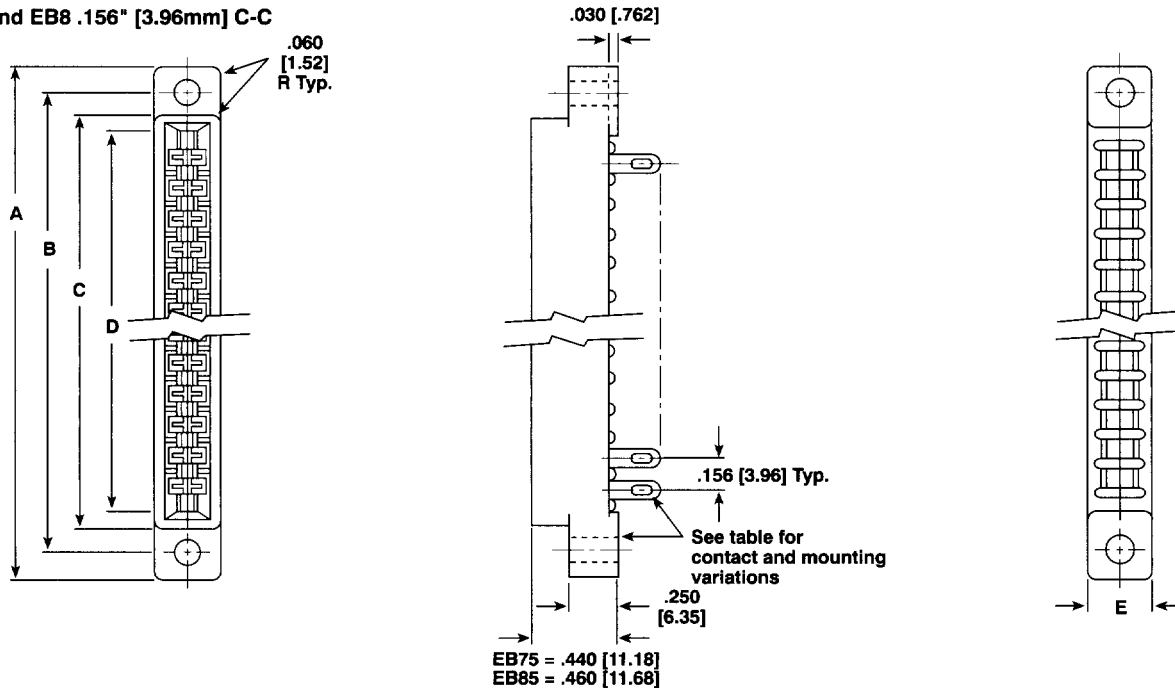

MODEL - PART NUMBER	# OF CONTACT POSITIONS PER SIDE	A	B	C	D	E	CARD SLOT DEPTH
EB8x-P□6GA	6	1.780 [45.21]	1.531 [38.89]	1.240 [31.50]	1.100 [27.94]	.340 [8.64]	.330 [8.38]
EB8x-P□10GA	10	2.410 [61.21]	2.156 [54.76]	1.864 [47.35]	1.724 [43.79]	.340 [8.64]	.330 [8.38]
EB8x-P□12GA	12	2.720 [69.09]	2.469 [62.71]	2.176 [55.27]	2.036 [51.71]	.340 [8.64]	.330 [8.38]
EB8x-P□15GA	15	3.190 [81.03]	2.937 [74.60]	2.644 [67.16]	2.504 [63.60]	.340 [8.64]	.330 [8.38]
EB8x-P□18GA	18	3.660 [92.96]	3.406 [86.51]	3.112 [79.04]	2.972 [75.49]	.340 [8.64]	.330 [8.38]
EB8x-P□22GA	22	4.280 [108.71]	4.031 [102.39]	3.736 [94.89]	3.596 [91.34]	.340 [8.64]	.330 [8.38]
EB8x-P□24GA	24	4.590 [116.59]	4.344 [110.34]	4.051 [102.90]	3.911 [99.34]	.340 [8.64]	.330 [8.38]
EB8x-P□25GA	25	4.750 [120.65]	4.500 [114.30]	4.207 [106.86]	4.067 [103.30]	.340 [8.64]	.330 [8.38]
EB7xD-P□36GA	36	6.530 [165.86]	6.219 [157.96]	5.906 [150.01]	5.778 [146.76]	.438 [11.13]	.260 [6.60]
EB7xD-P□43GA	43	7.615 [193.42]	7.302 [185.47]	7.000 [177.80]	6.802 [172.77]	.500 [12.70]	.260 [6.60]
RIGHT ANGLE DIMENSIONS							
EB7xD-PR6GA	6	1.780 [45.21]	1.531 [38.89]	1.218 [30.94]	1.100 [27.94]	.328 [8.33]	.260 [6.60]
EB7xD-PR10GA	10	2.410 [61.21]	2.156 [54.76]	1.843 [46.81]	1.724 [43.79]	.328 [8.33]	.260 [6.60]
EB7xD-PR12GA	12	2.720 [69.09]	2.468 [62.69]	2.156 [54.76]	2.036 [51.71]	.328 [8.33]	.260 [6.60]
EB7xD-PR15GA	15	3.190 [81.03]	2.937 [74.60]	2.624 [66.65]	2.504 [63.60]	.328 [8.33]	.260 [6.60]
EB7xD-PR18GA	18	3.660 [92.96]	3.406 [86.51]	3.093 [78.56]	2.972 [75.49]	.328 [8.33]	.260 [6.60]
EB7xD-PR22GA	22	4.280 [108.71]	4.031 [102.39]	3.717 [94.41]	3.596 [91.34]	.328 [8.33]	.260 [6.60]
EB7xD-PR36GA	36	6.530 [165.86]	6.219 [157.96]	5.906 [150.01]	5.778 [146.76]	.438 [11.13]	.260 [6.60]
EB7xD-PR43GA	43	7.615 [193.42]	7.302 [185.47]	7.000 [177.80]	6.802 [172.77]	.500 [12.70]	.260 [6.60]

ORDERING INFORMATION

When ordering connectors using the above Part Numbers:

x = Indicate "4" for 150°C Burn-In Connectors or "5" for 200°C Burn-In Connectors.

□ = Indicate "A" for Solder Eyelet or "E" for Card Extender. **Note:** Dimensions are the same for "A" or "E" styles.

Δ = Indicate "X" for Standard Mounting or "XS" for Side Mounting.