

# Surface Mount Polymer-Tantalum Capacitor

NTP Series

## FEATURES

- Ultra Low ESR and High Ripple Current Ratings
- Values from 2.2 $\mu$ F to 1,000 $\mu$ F
- Suitable for Reflow Soldering
- Available in J, P2, P, A2, A, B2, B, C2, C, C3, V and D Case Sizes

**EXPANDED**  
New Lower ESR and  
Reduced Case Size



## CHARACTERISTICS

Capacitance Range	2.2 $\mu$ F to 1000 $\mu$ F	
Capacitance Tolerance	$\pm$ 20% (M)	
Rated Voltage Range @ 85°C (Vdc)	2.5Vdc ~ 16Vdc*	
Operating Temperature Range	-55°C ~ +105°C (derating above +85°C)	
Dissipation Factor	See Specifications Table	
Leakage Current @ +25°C (After 5 Minutes at Rated Voltage)	Not More Than 0.1CV or 3 $\mu$ A, whichever is greater	
Capacitance Change With Temperature	-55°C	+105°C
	$\Delta$ C - 20%	$\Delta$ C +50%
Resistance to Soldering Heat (+240°C for 5 ~ 10 Seconds)	$\Delta$ C $\pm$ 20% Max, LC = Less than initial specification DF = 130% of initial measured value	
Moisture Resistance (500 hours; 90-95% RH @ 40°C)	$\Delta$ C +30% ~ -20% Max, LC = Less than initial specification DF = 130% of initial measured value	
Load Life at Rated Voltage (1,000 hours @ 85°C)	$\Delta$ C +30% Max, LC = Less than initial specification DF = 150% of initial measured value	
Base Failure Rate	1%/1000 hours at +85°C and rated voltage	

\* It is recommended that the applied voltage be less than 80% of the rated voltage

## STANDARD VALUES AND CASE SIZES

Rated Voltage @ +85°C	2.5	4.0	6.3	10	16	
Surge Voltage @ +85°C	3.3	5.2	8.0	13	20	
Derated Voltage @ 105°C	2.0	3.3	5.0	8.0	12.8	
Capacitance ( $\mu$ F)	Code	Case Size	Case Size	Case Size	Case Size	Case Size
2.2	225	-	-	J	J	-
3.3	335	-	-	J	J, A	A
4.7	475	-	-	J, P	J, A2, A	B
6.8	685	-	-	J, P, A	A2, A, B	B
10	106	-	J, P, A	P2, P, A2, A	P, A2, A, B	B
15	156	-	-	A2, A, B	A, B, C	-
22	226	P	P, A2, B	A2, A, B2, B	A, B2, B, C	-
33	336	A2	A2, A	A, B2, B	A, B2, B, C2, C	V
47	476	A2	A, B2	A, B2, B, C2, C	B2, B, C2, C, V, D	V, D
68	686	-	A, C2, C	B2, B, C2, C, V	C2, C, V, D	-
100	107	A, B2	A, B2, B, C2	A, B, C2, C, V	C2, C, V, D	-
150	157	-	B, C	B, C2, C, V, D	C, V, D	-
220	227	A, B	B, C, V, D	V, D	C3, D	-
330	337	B, C, V	C, V, D	V, D	-	-
470	477	V	D	-	-	-
680	687	D	D	-	-	-
1000	108	D	-	-	-	-

## PART NUMBER SYSTEM

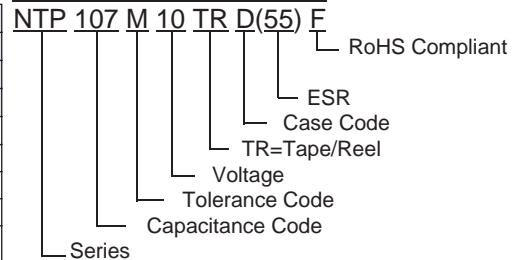

# Surface Mount Polymer-Tantalum Capacitor

NTP Series

## MAX. ESR (mΩ) @ 20°C/100KHz AND RIPPLE CURRENT (mArms) @20°C/100KHz

NIC Part Number	Capacitance Value (μF)	Working Voltage (Vdc)	Dissipation Factor @ +20°C/120Hz	ESR (mΩ) @+20°C/100KHz	Ripple Current Rating (mA) @ +20°C/100KHz
NTP226M2.5TRP(200)F	22	2.5	0.06	200	354
NTP336M2.5TRA2(150)F	33		0.06	150	632
NTP476M2.5TRA2(150)F	47		0.06	150	632
NTP107M2.5TRA(100)F	100		0.08	100	866
NTP107M2.5TRA(45)F	100		0.08	45	1291
NTP107M2.5TRA(35)F	100		0.08	35	1464
NTP107M2.5TRB2(70)F	100		0.08	70	1035
NTP227M2.5TRA(45)F	220		0.08	45	1291
NTP227M2.5TRA(35)F	220		0.08	35	1464
NTP227M2.5TRB(45)F	220		0.08	45	1374
NTP227M2.5TRB(35)F	220		0.08	35	1558
NTP227M2.5TRB(25)F	220		0.08	25	1844
NTP227M2.5TRB(21)F	220		0.08	21	2011
NTP227M2.5TRB(15)F	220		0.08	15	2380
NTP337M2.5TRB(45)F	330		0.08	45	1374
NTP337M2.5TRB(35)F	330		0.08	35	1558
NTP337M2.5TRB(21)F	330		0.10	21	2011
NTP337M2.5TRB(15)F	330		0.08	15	2380
NTP337M2.5TRB(9)F	330		0.08	9	3073
NTP337M2.5TRC(55)F	330		0.10	55	1414
NTP337M2.5TRC(45)F	330		0.10	45	1563
NTP337M2.5TRC(25)F	330		0.10	25	2345
NTP337M2.5TRC(18)F	330		0.10	18	2472
NTP337M2.5TRV(25)F	330		0.10	25	2236
NTP337M2.5TRV(15)F	330		0.10	15	2887
NTP337M2.5TRV(12)F	330		0.10	12	3227
NTP477M2.5TRV(15)F	470		0.10	15	2887
NTP477M2.5TRV(12)F	470		0.10	12	3227
NTP477M2.5TRV(7)F	470		0.10	7	4226
NTP477M2.5TRV(6)F	470		0.10	6	4546
NTP687M2.5TRD(25)F	680		0.10	25	2449
NTP687M2.5TRD(15)F	680		0.10	15	3162
NTP687M2.5TRD(12)F	680		0.10	12	3536
NTP108M2.5TRD(25)F	1000	0.10	25	2449	
*NTP108M2.5TRD(15)F	1000	0.10	15	3162	
*NTP108M2.5TRD(12)F	1000	0.10	12	3535	
NTP106M4TRJ(300)F	10	4.0	0.04	300	183
NTP106M4TRP(200)F	10		0.06	200	354
NTP106M4TRA(200)F	10		0.06	200	612
NTP226M4TRP(200)F	22		0.06	200	354
NTP226M4TRA2(200)F	22		0.06	200	548
NTP226M4TRB(150)F	22		0.08	150	753
NTP336M4TRA2(150)F	33		0.06	150	632
NTP336M4TRA(180)F	33		0.06	180	645
NTP476M4TRA(180)F	47		0.06	180	645
NTP476M4TRB2(70)F	47		0.08	70	1035
NTP686M4TRA(180)F	68		0.06	180	645
NTP686M4TRC2(55)F	68		0.08	55	1279
NTP686M4TRC(100)F	68		0.09	100	1049
NTP107M4TRA(100)F	100		0.06	100	866
NTP107M4TRA(45)F	100		0.08	45	1291
NTP107M4TRA(35)F	100		0.08	35	1464
NTP107M4TRB2(70)F	100		0.08	70	1035
NTP107M4TRB(70)F	100		0.08	70	1102
NTP107M4TRB(45)F	100		0.08	45	1374
NTP107M4TRB(35)F	100		0.08	35	1558
NTP107M4TRC2(55)F	100		0.09	55	1279
NTP157M4TRB(45)F	150		0.08	45	1374
NTP157M4TRB(35)F	150		0.08	35	1558
NTP157M4TRB(25)F	150		0.08	25	1844

\*Check with NIC regarding current availability

New Value



# Surface Mount Polymer-Tantalum Capacitor

NTP Series

## MAX. ESR (mΩ) @ 20°C/100KHz AND RIPPLE CURRENT (mArms) @20°C/100KHz

NIC Part Number	Capacitance Value (μF)	Working Voltage (Vdc)	Dissipation Factor @ +20°C/120Hz	ESR (mΩ) @+20°C/100KHz	Ripple Current Rating (mA) @ +20°C/100KHz	
NTP157M4TRC(100)F	150	4.0	0.09	100	1049	
NTP227M4TRB(45)F	220		0.08	45	1374	
NTP227M4TRB(35)F	220		0.08	35	1558	
NTP227M4TRC(55)F	220		0.09	55	1414	
NTP227M4TRC(45)F	220		0.09	45	1563	
NTP227M4TRC(25)F	220		0.09	25	2098	
NTP227M4TRC(18)F	220		0.09	18	2472	
NTP227M4TRV(45)F	220		0.10	45	1667	
NTP227M4TRV(25)F	220		0.10	25	2236	
NTP227M4TRV(18)F	220		0.10	18	2635	
NTP227M4TRV(15)F	220		0.10	15	2887	
NTP227M4TRV(12)F	220		0.10	12	3227	
NTP227M4TRD(55)F	220		0.10	55	1651	
NTP227M4TRD(40)F	220		0.10	40	1936	
NTP227M4TRD(25)F	220		0.10	25	2449	
NTP227M4TRD(15)F	220		0.10	15	3162	
NTP227M4TRD(12)F	220		0.10	12	3536	
NTP337M4TRC(55)F	330		0.10	55	1414	
NTP337M4TRV(45)F	330		0.10	45	1667	
NTP337M4TRV(25)F	330		0.10	25	2236	
NTP337M4TRV(12)F	330		0.10	12	3227	
NTP337M4TRD(40)F	330		0.10	40	1936	
NTP337M4TRD(25)F	330		0.10	25	2449	
NTP337M4TRD(15)F	330		0.10	15	3162	
NTP477M4TRD(25)F	470		0.10	25	2449	
NTP477M4TRD(18)F	470		0.10	18	2887	
NTP477M4TRD(15)F	470		0.10	15	3162	
NTP477M4TRD(12)F	470		0.10	12	3536	
NTP477M4TRD(10)F	470		0.10	10	3873	
NTP687M4TRD(25)F	680		0.10	25	2449	
NTP687M4TRD(15)F	680		0.10	15	3162	
NTP687M4TRD(12)F	680		0.10	12	3536	
NTP225M6.3TRJ(500)F	2.2		6.3	0.04	500	141
NTP335M6.3TRJ(500)F	3.3			0.04	400	141
NTP335M6.3TRP(300)F	3.3	0.06		300	289	
NTP475M6.3TRJ(500)F	4.7	0.04		500	141	
NTP475M6.3TRP(300)F	4.7	0.06		300	289	
NTP685M6.3TRJ(500)F	6.8	0.06		500	141	
NTP685M6.3TRP(300)F	6.8	0.06		300	289	
NTP685M6.3TRA(300)F	6.8	0.06		300	500	
NTP106M6.3TRP2(200)F	10	0.06		200	353	
NTP106M6.3TRP(200)F	10	0.06		200	354	
NTP106M6.3TRA2(200)F	10	0.06		200	548	
NTP106M6.3TRA(200)F	10	0.06		200	612	
NTP156M6.3TRA2(200)F	15	0.06		200	548	
NTP156M6.3TRA(200)F	15	0.06		200	612	
NTP156M6.3TRB(150)F	15	0.08		150	753	
NTP226M6.3TRA2(200)F	22	0.06		200	548	
NTP226M6.3TRA(180)F	22	0.06		180	645	
NTP226M6.3TRB2(70)F	22	0.08		70	1035	
NTP226M6.3TRB(150)F	22	0.08		150	753	
NTP336M6.3TRA(180)F	33	0.06		180	645	
NTP336M6.3TRB2(70)F	33	0.08		70	1035	
NTP336M6.3TRB(150)F	33	0.08		150	753	
NTP476M6.3TRA(180)F	47	0.06		180	645	
NTP476M6.3TRB2(70)F	47	0.08		70	1035	
NTP476M6.3TRB2(55)F	47	0.08		55	1168	
NTP476M6.3TRB(150)F	47	0.08		150	753	
NTP476M6.3TRB(70)F	47	0.08		70	1102	
NTP476M6.3TRC2(70)F	47	0.09		70	1134	
NTP476M6.3TRC(100)F	47	0.09		100	1049	



New Value

### MAX. ESR (mΩ) @ 20°C/100KHz AND RIPPLE CURRENT (mArms) @20°C/100KHz

NIC Part Number	Capacitance Value (μF)	Working Voltage (Vdc)	Dissipation Factor @ +20°C/120Hz	ESR (mΩ) @+20°C/100KHz	Ripple Current Rating (mA) @ +20°C/100KHz
NTP686M6.3TRB2(70)F	68	6.3	0.08	70	1035
NTP686M6.3TRB(70)F	68		0.08	70	1102
NTP686M6.3TRB(55)F	68		0.08	55	1243
NTP686M6.3TRC2(55)F	68		0.09	55	1279
NTP686M6.3TRC(100)F	68		0.09	100	1049
NTP107M6.3TRA(25)F	100		0.08	25	1732
NTP107M6.3TRB(70)F	100		0.08	70	1102
NTP107M6.3TRB(45)F	100		0.08	45	1374
NTP107M6.3TRB(35)F	100		0.08	35	1558
NTP107M6.3TRB(25)F	100		0.08	25	1844
NTP107M6.3TRC2(70)F	100		0.09	70	1134
NTP107M6.3TRC2(55)F	100		0.09	55	1279
NTP107M6.3TRC(100)F	100		0.09	100	1049
NTP107M6.3TRC(55)F	100		0.09	55	1414
NTP107M6.3TRV(18)F	100		0.10	18	2635
NTP107M6.3TRV(15)F	100		0.10	15	2886
NTP157M6.3TRB(45)F	150		0.08	45	1374
NTP157M6.3TRB(35)F	150		0.08	35	1558
NTP157M6.3TRB(25)F	150		0.08	25	1844
NTP157M6.3TRC2(55)F	150		0.09	55	1279
NTP157M6.3TRC(100)F	150		0.09	100	1049
NTP157M6.3TRC(55)F	150		0.09	55	1414
NTP157M6.3TRC(45)F	150		0.09	45	1563
NTP157M6.3TRC(25)F	150		0.09	25	2098
NTP157M6.3TRV(45)F	150		0.10	45	1667
NTP157M6.3TRV(25)F	150		0.10	25	2236
NTP157M6.3TRV(18)F	150		0.10	18	2635
NTP157M6.3TRV(15)F	150		0.10	15	2886
NTP157M6.3TRV(12)F	150		0.10	12	3227
NTP157M6.3TRD(55)F	150		0.10	55	1651
NTP157M6.3TRD(40)F	150		0.10	40	1936
NTP157M6.3TRD(25)F	150		0.10	25	2449
NTP227M6.3TRV(45)F	220		0.10	45	1667
NTP227M6.3TRV(25)F	220	0.10	25	2236	
NTP227M6.3TRV(15)F	220	0.10	15	2887	
NTP227M6.3TRV(12)F	220	0.10	12	3227	
NTP227M6.3TRD(55)F	220	0.10	55	1651	
NTP227M6.3TRD(40)F	220	0.10	40	1936	
NTP337M6.3TRV(45)F	330	0.10	45	1667	
NTP337M6.3TRV(25)F	330	0.10	25	2236	
NTP337M6.3TRD(40)F	330	0.10	40	1936	
NTP337M6.3TRD(25)F	330	0.10	25	2449	
NTP337M6.3TRD(18)F	330	0.10	18	2887	
NTP225M10TRJ(500)F	2.2	10	0.04	500	141
NTP335M10TRJ(500)F	3.3		0.06	500	141
NTP335M10TRA(300)F	3.3		0.06	300	500
NTP475M10TRJ(500)F	4.7		0.06	500	141
NTP475M10TRA2(300)F	4.7		0.06	300	447
NTP475M10TRA(300)F	4.7		0.06	300	500
NTP685M10TRA2(300)F	6.8		0.06	300	447
NTP685M10TRA(300)F	6.8		0.06	300	500
NTP685M10TRB(200)F	6.8		0.08	200	652
NTP106M10TRP(200)F	10		0.06	200	353
NTP106M10TRA2(200)F	10		0.06	200	548
NTP106M10TRA(200)F	10		0.06	200	612
NTP106M10TRB(200)F	10		0.08	200	652
NTP156M10TRA(180)F	15		0.06	180	645
NTP156M10TRB(150)F	15		0.08	150	753
NTP156M10TRC(200)F	15		0.09	200	742
NTP226M10TRA(180)F	22		0.06	180	645
NTP226M10TRB2(70)F	22		0.08	70	1035

New Value



# Surface Mount Polymer-Tantalum Capacitor

NTP Series

## MAX. ESR (mΩ) @ 20°C/100KHz AND RIPPLE CURRENT (mArms) @20°C/100KHz

NIC Part Number	Capacitance Value (μF)	Working Voltage (Vdc)	Dissipation Factor @ +20°C/120Hz	ESR (mΩ) @+20°C/100KHz	Ripple Current Rating (mA) @ +20°C/100KHz
NTP226M10TRB(150)F	22	10	0.08	150	753
NTP226M10TRC(150)F	22		0.09	150	856
NTP336M10TRA(200)F	33		0.06	200	612
NTP336M10TRB2(70)F	33		0.08	70	1035
NTP336M10TRB(150)F	33		0.08	150	753
NTP336M10TRC2(70)F	33		0.09	70	1134
NTP336M10TRC(100)F	33		0.09	100	1049
NTP476M10TRB2(70)F	47		0.08	70	1035
NTP476M10TRB(70)F	47		0.08	70	1102
NTP476M10TRC2(70)F	47		0.09	70	1134
NTP476M10TRC(100)F	47		0.09	100	1049
NTP476M10TRC(55)F	47		0.09	55	1414
NTP476M10TRV(60)F	47		0.10	60	1443
NTP476M10TRD(100)F	47		0.10	100	1225
NTP686M10TRC2(55)F	68		0.09	55	1279
NTP686M10TRC(100)F	68		0.09	100	1049
NTP686M10TRC(55)F	68		0.09	55	1414
NTP686M10TRV(60)F	68		0.10	60	1443
NTP686M10TRD(100)F	68		0.10	100	1225
NTP107M10TRV(45)F	100		0.10	45	1667
NTP107M10TRV(25)F	100		0.10	25	2236
NTP107M10TRC2(70)F	100		0.09	70	1134
NTP107M10TRC2(55)F	100		0.09	55	1279
NTP107M10TRC(100)F	100		0.09	100	1049
NTP107M10TRC(55)F	100		0.09	55	1414
NTP107M10TRD(55)F	100		0.10	55	1651
NTP157M10TRC(55)F	150		0.09	55	1414
NTP157M10TRV(45)F	150		0.10	45	1667
NTP157M10TRV(40)F	150		0.10	40	1768
NTP157M10TRD(55)F	150		0.10	55	1651
NTP157M10TRD(40)F	150		0.10	40	1936
NTP221M10TRC3(55)F	220		0.10	55	1414
NTP227M10TRD(55)F	220		0.10	55	1651
NTP227M10TRD(40)F	220	0.10	40	1936	
NTP227M10TRD(25)F	220	0.10	25	2449	
NTP335M16TRA(800)F	3.3	16	0.06	800	306
NTP475M16TRB(200)F	4.7		0.08	200	652
NTP685M16TRB(200)F	6.8		0.08	200	652
NTP106M16TRB(100)F	10		0.08	100	922
NTP336M16TRV(70)F	33		0.10	70	1336
NTP476M16TRV(70)F	47		0.10	70	1336
NTP476M16TRD(70)F	47		0.10	70	1464



### CASE DIMENSIONS (mm)

Case Size	EIA Code	L	H	W <sub>1</sub>	W <sub>2</sub>	T
J	0603	1.6 ± 0.1	0.8 ± 0.1	0.8 ± 0.1	0.6 ± 0.1	0.3 ± 0.15
P2	2012L	2.0 ± 0.2	0.9 ± 0.1	1.25 ± 0.2	0.9 ± 0.1	0.55 ± 0.1
P	2012	2.0 ± 0.2	1.1 ± 0.1	1.25 ± 0.2	0.9 ± 0.1	0.5 ± 0.1
A2	3216L	3.2 ± 0.2	1.1 ± 0.1	1.6 ± 0.2	1.2 ± 0.1	0.8 ± 0.2
A	3216	3.2 ± 0.2	1.6 ± 0.2	1.6 ± 0.2	1.2 ± 0.1	0.8 ± 0.2
B2	3528L	3.5 ± 0.2	1.1 ± 0.1	2.8 ± 0.2	2.2 ± 0.1	0.8 ± 0.2
B	3528	3.5 ± 0.2	1.9 ± 0.2	2.8 ± 0.2	2.2 ± 0.1	0.8 ± 0.2
C2	6032L	6.0 ± 0.2	1.4 ± 0.1	3.2 ± 0.2	2.2 ± 0.1	1.3 ± 0.2
C	6032	6.0 ± 0.2	2.5 ± 0.3	3.2 ± 0.2	2.2 ± 0.1	1.3 ± 0.2
C3	6032	6.0 ± 0.2	2.8 ± 0.1	3.2 ± 0.2	2.2 ± 0.1	1.3 ± 0.2
V	7343	7.3 ± 0.2	1.9 ± 0.1	4.3 ± 0.2	2.4 ± 0.1	1.3 ± 0.2
D	7343	7.3 ± 0.2	2.8 ± 0.2	4.3 ± 0.2	2.4 ± 0.1	1.3 ± 0.2

### RIPPLE CURRENT TEMPERATURE DERATING

20°C	85°C	105°C
1.0	0.9	0.6

“J, P2, P, A2, A” Case Size

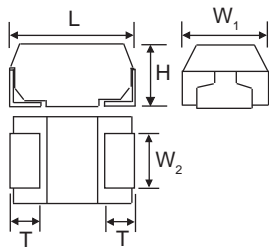

### Polarity Indicator



Silver Band Denotes Anode Termination

“C, C2, C3, V & D” Case Size

“B2, B” Case Size

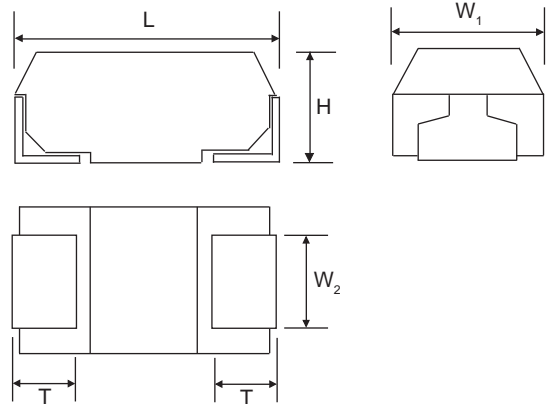
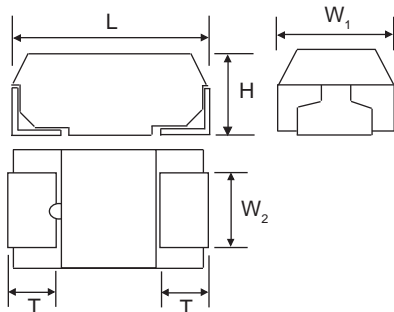

### TAPE SPECIFICATIONS (mm)

Case Size	A ±0.2	B ±0.2	C ±0.3	D ±0.1	E ±0.1	F ±0.1	G ±0.05	H ±0.1	J +0.1	K ±0.2	t max.	Reel Qty
J	1.0	1.8	8.0	3.5	1.75	4.0	2.0	4.0	φ1.5	1.1	0.2	4000
P	1.4	2.2								1.4		3000
A2	1.9	3.8								1.4		3000
A	1.9									1.9		2000
B2	3.2									1.4		3000
B	3.3	6.4	1.7	2000								
C2	3.7		3.0	0.3	1000							
C	3.7		3.4	0.3	500							
C3	3.7	7.7	2.1	0.4	1000							
V	4.8		3.3	0.3	500							
D	4.8		3.3	0.3	500							

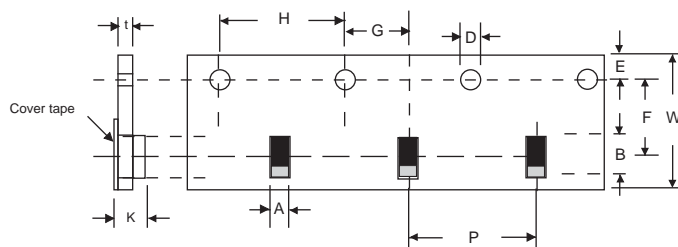

## REEL SPECIFICATIONS (mm)

Tape Width	A ± 2.0	B min.	C ± 0.5	D ± 0.5	E ± 0.5	W <sub>1</sub> ± 1.0	W <sub>2</sub> max.
8mm	φ178	φ50	φ13	φ21	2.0	10	14.5
12mm						14.5	18.5

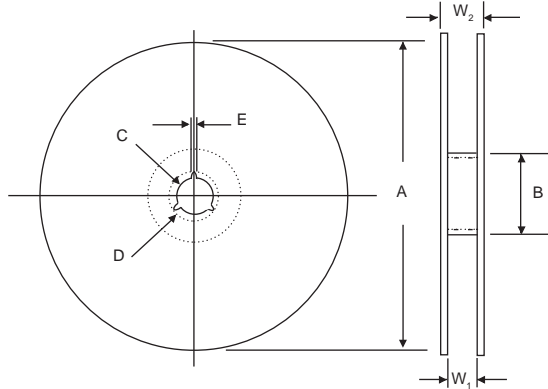

## RECOMMENDED PEAK TEMPERATURE/TIME

Maximum Time	Peak Soldering Temperature
5 Seconds	250°C
10 Seconds	240°C
20 Seconds	230°C

## RECOMMENDED LAND PATTERN (mm)

Case Size	S max.	X min.	Y min.
J	0.7	2.5	1.0
P2	1.05	2.05	0.8
P	0.5	2.6	1.2
A2	1.1	3.8	1.5
A	1.1	3.8	1.5
B	1.4	4.1	2.7
C2	2.9	6.9	2.7
C	2.9	6.9	2.7
C3	2.9	6.9	2.7
D	4.1	8.2	2.9

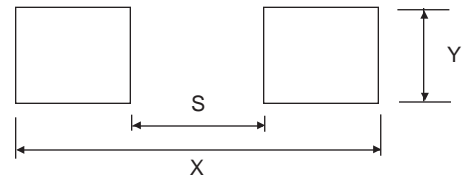

## PRECAUTIONS

Please review the notes on correct use, safety and precautions found on our website at [www.niccomp.com/tantpc](http://www.niccomp.com/tantpc)  
 If in doubt or uncertainty, please review your specific application - process details with NIC's technical support personnel: [tpmg@niccomp.com](mailto:tpmg@niccomp.com)

