

Tous droits strictement réservés. Reproduction ou communication o des tiers interdite sous quelque forme que ce soit sans autorisation écrite du propriétaire. Propriété de c F.C.I. Droits de reproduction F.C.I.

All rights strictly reserved. Reproduction or issue to third parties in any form, whenever is not permitted without written authority from the proprietor. Property of F.C.I. Copyright F.C.I.

PRODUCT NUMBER
51760- ABBCCDDEF
SEE NOTE 1

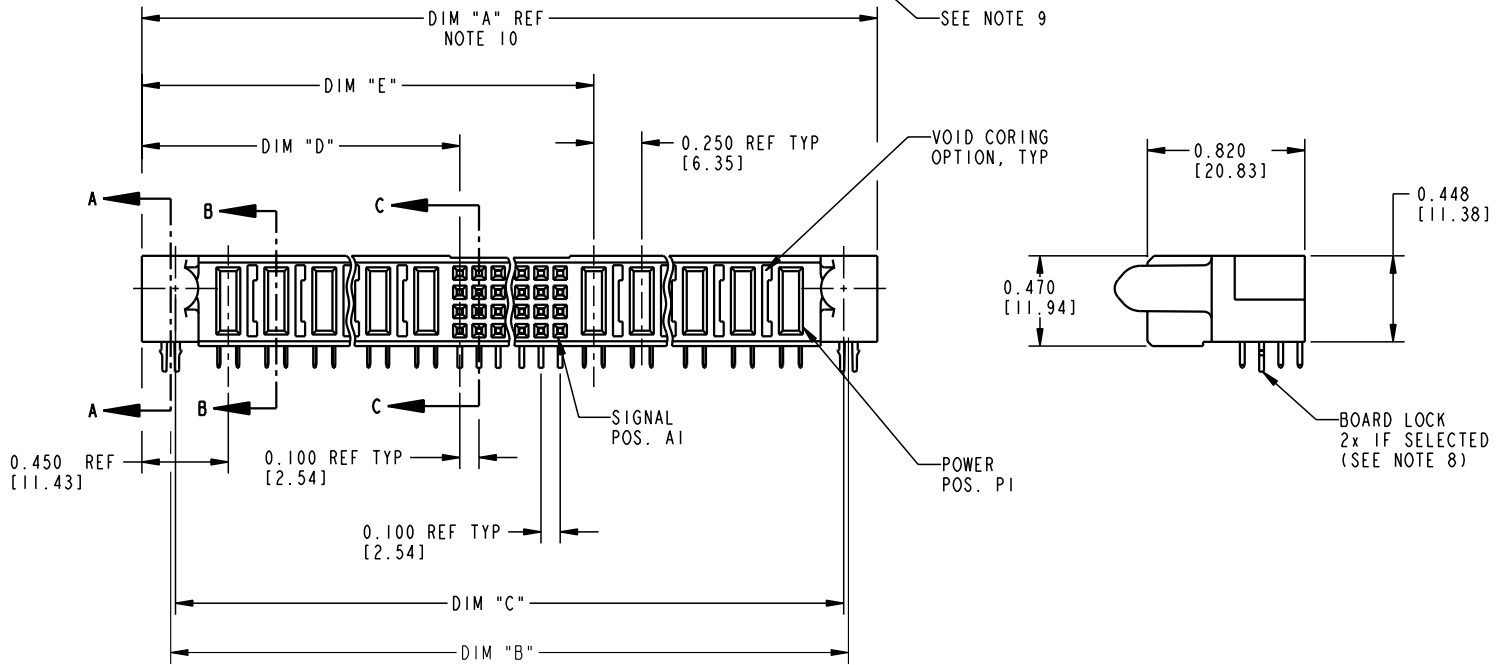
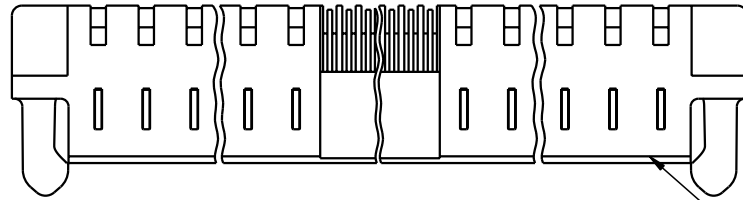

mat'l code SEE NOTE 2				tolerances unless otherwise specified		CUSTOMER COPY	 www.fciconnect.com		
ltr	ecn no.	dr	date	linear	.XX±.01/.X±.3	projection			
B	V91363	CHB	06-11-99		.XXX±.005/.XX±.13	 INCH / MM	title RIGHT ANGLE RECEPTACLE w/GUIDE PIN POWER / SIGNAL / POWER		
C	V94083	CHB	11-01-99	angles	.XXXX±.0020/.XXX±.051		product family PwrBlade	code 213	
D	V94413	EKK	01-13-00		0°±2°	scale 1:1	size A	dwg no 51760	SHEET 1 OF 3
E	V01396	EKK	06-28-00	dr	D. BOGLE 05-18-99				
F	V01898	CHB	08-04-00	engr	J. BROWN 05-18-99				
G	V02389	JWS	10-6-00	chr	J. BROWN 05-18-99				
H	V21511	CGD	09/23/02	appd	J. BROWN 05-18-99				
sheet index	revision sheet	H 1	H 2	H 3					

THIS FILE WAS ORIGINALLY CREATED IN THE PRO ENGINEER ENVIRONMENT AND ANY FUTURE REVISIONS TO THIS FILE MUST BE MADE IN THE PRO ENGINEER ENVIRONMENT

form no. 7530-001-103

cage code 22526

PDM: Rev:H

STATUS: Released

Printed: Nov 09, 2002

Tous droits strictement réservés. Reproduction ou communication à des tiers interdite sous quelque forme que ce soit sans autorisation écrite du propriétaire. Propriété de c FCI. Droits de reproduction FCI.

A FCI

All rights strictly reserved. Reproduction or issue to third parties in any form, whenever is not permitted without written authority from the proprietor. Property of FCI. Copyright FCI.

B

PRODUCT NUMBER		DIM		LENGTH FORMULAS (SEE NOTE 10)			
51760-ABBCCDDEF		DIM "A"		.250 [6.35] x DD + .100 [2.54] x (CCC/4) + .250 [6.35] x BB + .650 [16.51] (NOTE 10)			
SEE NOTE 1		DIM "B"		.250 [6.35] x DD + .100 [2.54] x (CCC/4) + .250 [6.35] x BB + .350 [8.89]			
		DIM "C"		.250 [6.35] x DD + .100 [2.54] x (CCC/4) + .250 [6.35] x BB + .300 [7.62]			
		DIM "D"		.250 [6.35] x DD + .375 [9.35]			
		DIM "E"		.250 [6.35] x DD + .100 [2.54] x (CCC/4) + .450 [11.43]			
		DIM "F"		.250 [6.35] x DD + .100 [2.54] x (CCC/4) + .250 [6.35] x BB + .680 [17.27]			
		DIM "G"		.250 [6.35] x DD + .225 [5.72]			
		DIM "H"		.250 [6.35] x DD + .100 [2.54] x (CCC/4) + .250 [6.35]			

CONNECTOR NOTES

① PRODUCT NUMBER CODE:
51760 - A BB CCC DD E F

RETENTION TO PCB (NOTE 8)
TAIL OPTIONS (NOTE 7)
NUMBER OF LEFT END POWER CONTACTS (NOTE 6)
NUMBER OF SIGNAL CONTACTS (NOTE 5)
NUMBER OF RIGHT POWER CONTACTS (NOTE 4)
PLATING (NOTE 3)
BASE NUMBER

② HOUSING MATERIAL: GLASS FILLED V-O HIGH TEMP THERMO PLASTIC.
SIGNAL CONTACT MATERIAL: COPPER ALLOY
POWER CONTACT MATERIAL: COPPER ALLOY

③ PLATING OPTION:
1 = SIGNAL CONTACTS: 30u" / .76u OVER 50u" / 1.27u Ni
POWER CONTACTS: 50u" / 1.2u Ni UNDERPLATE OVERALL
30u" / .76u" Au ON CONTACT AREA
WITH SnPb ON PCB INTERFACE

④ RIGHT END POWER CONTACTS, 01 TO 19 AVAILABLE.
MAXIMUM OF 20 POWER CONTACTS PER CONNECTOR

⑤ SIGNAL CONTACTS, 004 TO 148 AVAILABLE.

⑥ LEFT END POWER CONTACTS, 01 TO 19 AVAILABLE.
MAXIMUM OF 20 POWER CONTACTS PER CONNECTOR

⑦ TAIL OPTIONS:
A = .135 ± .010 [3.43 ± .25] SOLDER TO BOARD
B = .090 + .005 / -.010 [2.29 + 0.13 / -.025] SOLDER TO BOARD

⑧ RETENTION TO PCB OPTIONS:
A = BOARD LOCK (REQUIRES .098 + .002 / -.001 [2.49 + 0.05 / -0.03] THRU HOLE IN PCB MOUNTING FOOT HEIGHT: .220 [5.59])
B = .150 [3.81] THRU HOLE (REQUIRES .158 ± 0.003 [4.01 ± 0.08] THRU HOLE IN PCB). MOUNTING FOOT HEIGHT .160 [4.06]

⑨ MANUFACTURE'S NAME, P/N, AND DATE CODE TO APPEAR ON THIS SURFACE.

⑩ THE MAXIMUM OVERALL LENGTH (DIM A) OF A PART IS 8.00 [203.2]
11. PRODUCT SPECIFICATION GS-12-149
12. APPLICATION SPECIFICATION BUS-20-067.

PCB NOTES:
13. ALL DIMENSIONS ARE BASIC UNLESS OTHERWISE SPECIFIED.
14. ALL THROUGH HOLES ARE LOCATED WITH A TRUE POSITION OF .004 [0.10]
15. ALL HOLE DIAMETERS ARE FINISHED HOLE SIZE.
16. Ø 0.0453 ± .001 [1.151 ± 0.02] DRILLED HOLES PLATED WITH 0.0003 [0.007] MIN SnPb OVER 0.001 [1.03] TO .003 [0.08] PLATING TO ACHIEVE A .040 ± .003 [1.02 ± 0.08] HOLE.

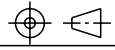
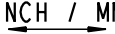
mat'l code				tolerances unless otherwise specified				CUSTOMER COPY		 www.fciconnect.com		
ltr	ecn no.	dr	date	linear	.XX±.01 / .X±.3		projection			title		
H					.XXX±.005 / .XX±.13					RIGHT ANGLE RECEPTACLE w/GUIDE PIN POWER / SIGNAL / POWER		
				angles	.XXX±.0020 / .XXX±.051			product family		code		
					0° ± 2°			PwrBlade		213		
				dr	D. BOGLE	05-18-99	INCH / MM		product family		code	
				enrg	J. BROWN	05-18-99	scale		size		213	
				chr	J. BROWN	05-18-99	1:2		51760		SHEET 2 OF 3	
				appd	J. BROWN	05-18-99			A			
sheet index		revision sheet										

THIS FILE WAS ORIGINALLY CREATED IN THE PRO ENGINEER ENVIRONMENT AND ANY FUTURE REVISIONS TO THIS FILE MUST BE MADE IN THE PRO ENGINEER ENVIRONMENT

form no. 7530-001-103

cage code 22526

PDM: Rev:H

STATUS: Released

Printed: Nov 09, 2002

Tous droits strictement réservés. Reproduction ou communication o des tiers interdite sous quelque forme que ce soit sans autorisation écrite du propriétaire. Propriété de c FCI. Droits de reproduction FCI.

FCI

All rights strictly reserved. Reproduction or issue to third parties in any form, whenever is not permitted without written authority from the proprietor. Property of FCI. Copyright FCI.

PRODUCT NUMBER
51760 - ABBCCCDDEF

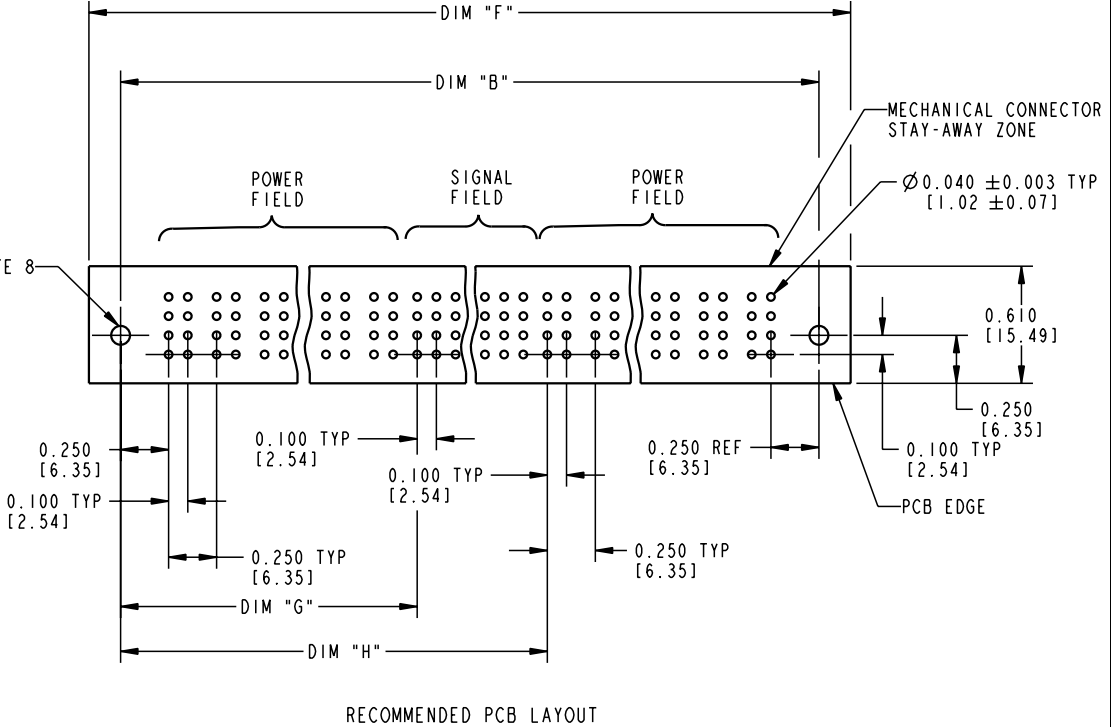
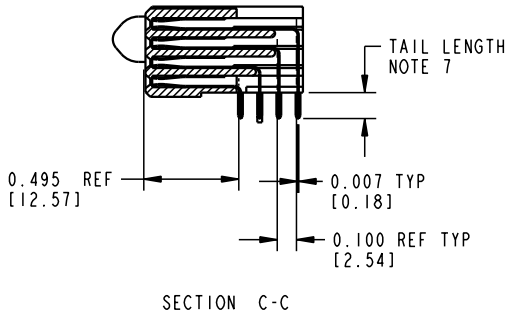
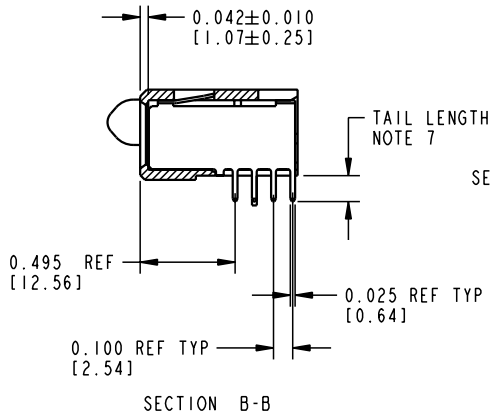
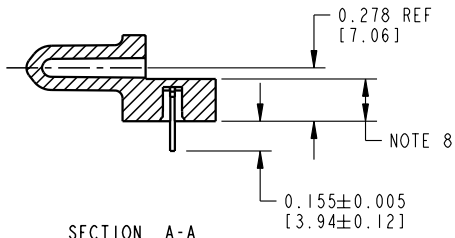

mat'l code				tolerances unless otherwise specified				CUSTOMER COPY		www.fciconnect.com	
ltr	ecr no.	dr	date	linear	.XX±.01/.X±.3		projection			title	
H					.XXX±.005/.XX±.13					RIGHT ANGLE RECEPTACLE w/GUIDE PIN	
					.XXXX±.0020/.XXX±.051					POWER / SIGNAL / POWER	
				angles	0°±2°		INCH / MM		product family		
				dr	D. BOGLE	05-18-99	scale		PwrBlade		
				engr	J. BROWN	05-18-99	1:1		code		
				chr	J. BROWN	05-18-99			213		
				appd	J. BROWN	05-18-99			SHEET		
sheet index		revision sheet						A		3 OF 3	
								51760			

form no. 7530-001-103

cage code 22526

Direct Link

- Cross reference
- RoHS/LF P/N Search
- Customer drawing search
- 3D model search
- Application tooling

Start > Search=51760-1000*

Search=51760-1000*

[Search](#)
[Tips](#) [Glossary](#)

You can also select multiple products and click 'Compare' to view a side-by-side feature comparison

[Compare](#) [Show Product Images](#)

Results 1

Services

- Contact us
- Distributor list
- Price request
- Order samples

Documentation

- Free search
- Search by category

Browse

Categories
[> Product type \(4\)](#)

Narrow By [Expand](#)

<input type="checkbox"/>	Part Number	Status	Product Name	Alternate PN	Check dis
<input type="checkbox"/>	51760-10002004AA	<input type="checkbox"/>	20P 4S STB Right Angle Receptacle	51760-10002004AALF	
<input type="checkbox"/>	51760-10002004AALF	<input type="checkbox"/>	20P 4S STB Right Angle Receptacle		
<input type="checkbox"/>	51760-10002806AA	<input type="checkbox"/>	28P 6S STB Right Angle Receptacle		
<input type="checkbox"/>	51760-10001604AA	<input type="checkbox"/>	16P 4S STB Right Angle Receptacle		
<input type="checkbox"/>	51760-10001204AALF	<input type="checkbox"/>	R/A REC, PWRBLADE		
<input type="checkbox"/>	51760-10002406AALF	<input type="checkbox"/>	PWRBLADE R/A LF REC		
<input type="checkbox"/>	51760-10004000AA	<input type="checkbox"/>	PWRBLADE R/A REC		
<input type="checkbox"/>	51760-10004802AALF	<input type="checkbox"/>	R/A REC, PWRBALDE		

LF Suffix : For Electronics division Items, all part numbers ending in LF are EU and China RoHS Compatible

- Number of contacts (Total -
- Number of contacts (Total -
- RoHS Lead Free Compatib





Company Brands Sales channels Press room Careers Contact us Languages

Regi
Logi
Pass
Forg
Reg

search by P/N or text **GO**

Product Type Connection Type Markets Applications Alphabetical List P

 Direct Link 

Start > Search=51760-100148*

 Services 

Search=51760-100148*



Sea

 Documentation 

You can also select multiple products and click 'Compare' to view a side-by-side feature comparison

Compare Show Product Images

F

<input type="checkbox"/> Part Number	Status	Product Name	Alternate PN
<input type="checkbox"/> 51760-10014800AA		148P STB Right Angle Receptacle	
<input type="checkbox"/> 51760-10014800AB		148P STB Right Angle Receptacle	











Company Brands Sales channels Press room Careers Contact us Languages

Regi
Logi
Pass
Forg
Reg

search by P/N or text **GO**

Product Type Connection Type Markets Applications Alphabetical List P

-  Direct Link 
-  Services 
-  Documentation 



Start > Search=51760-10203200*
Search=51760-10203200*

Sea
I

You can also select multiple products and click 'Compare' to view a side-by-side feature comparison

 Narrow By  Expand

Compare Show Product Images **F**

<input type="checkbox"/> Part Number	Status	Product Name	Alternate PN
<input type="checkbox"/> 51760-10203200AA		20P 32S STB Right Angle Receptacle	51760-10203200AALF
<input type="checkbox"/> 51760-10203200AALF		20P 32S STB Right Angle Receptacle	

- RoHS Lead Free Compatib 

LF Suffix : For Electronics division Items, all part numbers ending in LF are EU and China RoHS Compatible