

- NOTES:**
- HOUSING MATERIAL: GLASS FILLED LIQUID CRYSTAL POLYMER, UL94V-0, COLOR: BLACK
TERMINAL MATERIAL: BRASS ALLOY
 - FINISH: A = .000100/(0.00254) MIN. TIN OVER
.000050/(0.00127) MIN. NICKEL PLATE.
B = .000015/(0.00038) MIN. SELECT GOLD IN CONTACT AREA,
.000100/(0.00254) MIN. SELECT MATTE TIN ON SOLDER TAILS,
BOTH OVER .000050/(0.00127) MIN. NICKEL PLATE.
C = .000030/(0.00076) MIN. SELECT GOLD IN CONTACT AREA,
.000100/(0.00254) MIN. SELECT MATTE TIN ON SOLDER TAILS,
BOTH OVER .000050/(0.00127) MIN. NICKEL PLATE.
* THE PRIMARY SHIPPING CARTON WILL BE LABELED "COMPLIANT TO RoHS DIRECTIVE
2002/95/EC AND ELV ANNEX II OF DIRECTIVE 2000/53/EC." CARTONS WITHOUT
THIS LABEL MAY CONTAIN PRODUCT WITH TIN/LEAD IN THE PC TAIL AREA.
 - PRODUCT SPECIFICATION: PS-43045
 - TRAY PACKAGED : SEE MOLEX DRAWING PK-70873-0313
 - MATES WITH MICRO FIT (3.0) RECEPTACLE SERIES 43025
 - .010/0.25 OFFSETS ARE PRESENT ON ALL PARTS MANUFACTURED AFTER 11/1/2007,
AND ON PARTS PRIOR TO 11/1/2007 THAT CONTAIN A GREEN DOT ON THE PRIMARY
SHIPPING CARTON LABEL.
 - TO AVOID INTERFERENCE BETWEEN RECEPTACLE AND PCB, HEADER MUST BE PLACED
WITHIN .400/(10.16) MAX. FROM EDGE OF PCB, AS SHOWN IN LOCATION DETAIL.
 - THIS PART CONFORMS TO CLASS B REQUIREMENTS OF PRODUCT SPECIFICATION
PS-45499-002.

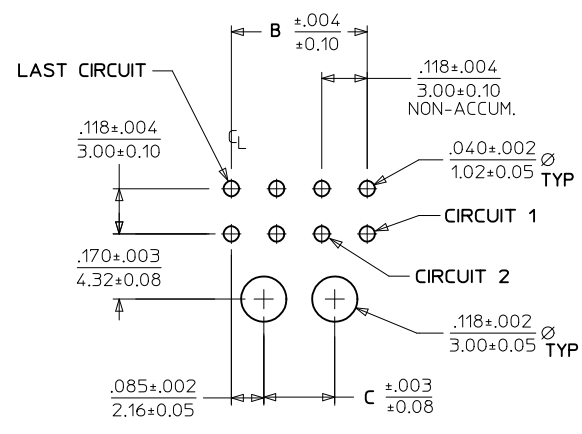

PCB LAYOUT: COMPONENT SIDE
RECOMMEND PCB THICKNESS: .062/1.57

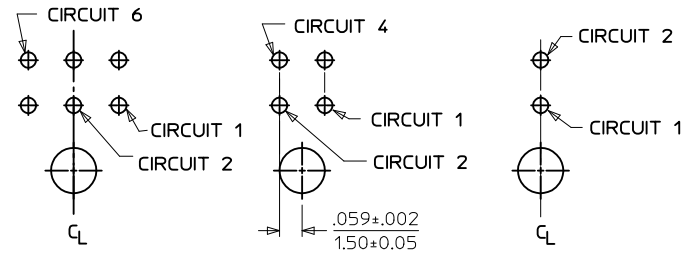

PCB LAYOUT: 6 CKT HEADER PCB LAYOUT: 4 CKT HEADER PCB LAYOUT: 2 CKT HEADER

CKTS	FINISH A	FINISH B	FINISH C
	MATERIAL NO:	MATERIAL NO:	MATERIAL NO:
02	43045-0200	43045-0201	43045-0202
04	43045-0400	43045-0401	43045-0402
06	43045-0600	43045-0601	43045-0602
08	43045-0800	43045-0801	43045-0802
10	43045-1000	43045-1001	43045-1002
12	43045-1200	43045-1201	43045-1202
14	43045-1400	43045-1401	43045-1402
16	43045-1600	43045-1601	43045-1602
18	43045-1800	43045-1801	43045-1802
20	43045-2000	43045-2001	43045-2002
22	43045-2200	43045-2201	43045-2202
24	43045-2400	43045-2401	43045-2402

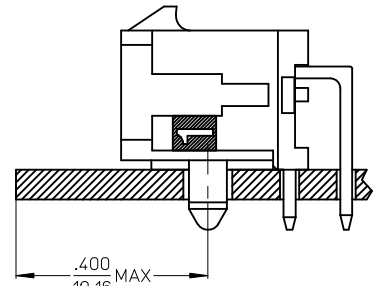

LOCATION DETAIL
SEE NOTE #7

CORRECTED .482/12.24 EC NO: UCP2010-1324 DRAWN:TBENES 2009/11/25 CHKD:SSOUSEK 2009/11/25 APPR:FSMLTH 2009/11/30	QUALITY SYMBOLS	GENERAL TOLERANCES (UNLESS SPECIFIED)	DIMENSION STYLE	SCALE	DESIGN UNITS	THIRD ANGLE PROJECTION
	▽=0	mm INCH	IN/MM	---	METRIC	
	▽=0	4 PLACES ± --- ± ---	DRAWN BY DATE	TITLE	MICRO-FIT (3.0) DUAL ROW RIGHT ANGLE THRU HOLE HEADER ASSY MOLEX INCORPORATED	
	▽=0	3 PLACES ± --- ± .010	CHECKED BY DATE	DOCUMENT NO.		
	2 PLACES ± 0.25 ± .014	1 PLACE ± 0.36 ± ---	APPROVED BY DATE		SHEET NO.	
	ANGULAR ±1/2°	DRAFT WHERE APPLICABLE MUST REMAIN WITHIN DIMENSIONS	MATERIAL NO.		SD-43045-001	1 OF 1
			SIZE C	THIS DRAWING CONTAINS INFORMATION THAT IS PROPRIETARY TO MOLEX INCORPORATED AND SHOULD NOT BE USED WITHOUT WRITTEN PERMISSION		

20 19 18 17 16 15 14 13 12 11 9 8 7 6 5 4 3 2 1

MICRO-FIT(3.0)
DUAL-ROW SERIES

MICRO-FIT(3.0)
IN-LINE SERIES

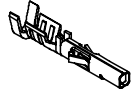

43030-xxxx
FEMALE CRIMP TERMINAL

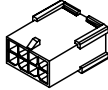

43020-xx01
PLUG W/O MTG. EARS

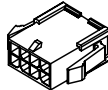

43020-xx00
PLUG W/ MTG. EARS

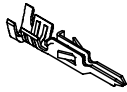

43031-xxxx
MALE CRIMP TERMINAL

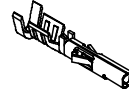

43030-xxxx
FEMALE CRIMP TERMINAL

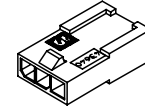

43640-xx01
PLUG W/O MTG. EARS

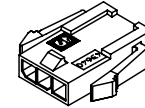

43640-xx00
PLUG W/ MTG. EARS

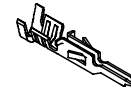

43031-xxxx
MALE CRIMP TERMINAL

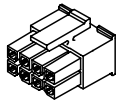

43025-xxxx
RECEPTACLE

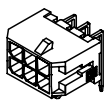

43045-xx00 THRU 43045-xx02
RIGHT ANGLE THRU HOLE
W/RETENTION PEG

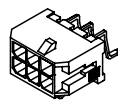

43045-xx03 THRU 43045-xx05
RIGHT ANGLE SURFACE MOUNT
W/RETENTION PEG

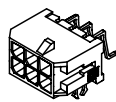

43045-xx06 THRU 43045-xx08
RIGHT ANGLE SURFACE MOUNT
W/RETENTION CLIP

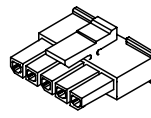

43645-xxxx
RECEPTACLE

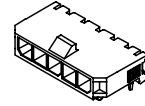

43650-xx00 THRU 43650-xx02
RIGHT ANGLE THRU HOLE
W/RETENTION PEG

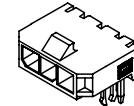

43650-xx03 THRU 43650-xx05
RIGHT ANGLE THRU HOLE
W/RETENTION CLIP

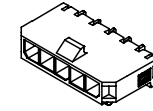

43650-xx06 THRU 43650-xx08
RIGHT ANGLE SURFACE MOUNT
W/RETENTION PEG

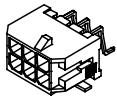

43045-xx09 THRU 43045-xx11
RIGHT ANGLE SURFACE MOUNT
W/FITTING NAIL

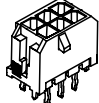

43045-xx12 THRU 43045-xx14
VERTICAL O.T.R. THRU HOLE

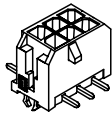

43045-xx15 THRU 43045-xx17
VERTICAL SURFACE MOUNT
W/RETENTION CLIP

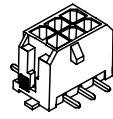

43045-xx18 THRU 43045-xx20
VERTICAL SURFACE MOUNT
W/FITTING NAIL

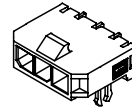

43650-xx09 THRU 43650-xx11
RIGHT ANGLE SURFACE MOUNT
W/RETENTION CLIP

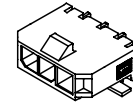

43650-xx12 THRU 43650-xx14
RIGHT ANGLE SURFACE MOUNT
W/FITTING NAIL

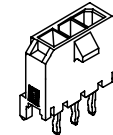

43650-xx15 THRU 43650-xx17
VERTICAL O.T.R. THRU HOLE

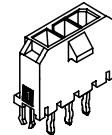

43650-xx18 THRU 43650-xx20
VERTICAL O.T.R. THRU HOLE
W/RETENTION CLIP

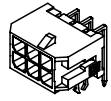

43045-xx21 THRU 43045-xx23
RIGHT ANGLE THRU HOLE
W/RETENTION CLIP

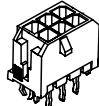

43045-xx24 THRU 43045-xx26
VERTICAL O.T.R. THRU HOLE
W/RETENTION CLIP

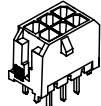

43045-xx27 THRU 43045-xx29
VERTICAL STRAIGHT PIN THRU HOLE

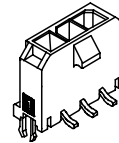

43650-xx21 THRU 43650-xx23
VERTICAL SURFACE MOUNT
W/RETENTION CLIP

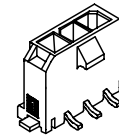

43650-xx24 THRU 43650-xx26
VERTICAL SURFACE MOUNT
W/FITTING NAIL

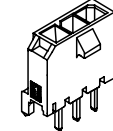

43650-xx27 THRU 43650-xx29
VERTICAL STRAIGHT PIN THRU HOLE

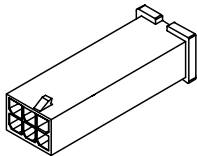

44242-0001 THRU 44242-0011
4-24 CKT. TEST PLUG

REVISED/REDRAWN EC NO. UCP2004-1223 DRWN: ICERNY 2004/03/12 CHKD: CHKCD 2004/03/31 APPR: FSMITH 2004/04/05	QUALITY SYMBOLS	GENERAL TOLERANCES (UNLESS SPECIFIED)		SCALE	DESIGN UNITS	THIRD ANGLE PROJECTION	REVISE ON CAD ONLY	
	▽ 0 ▽ 0	4 PLACES ± 0.15 3 PLACES ± 0.20 2 PLACES ± 0.25 1 PLACE ± 0.30	mm INCH	IN/MM	DIMENSION STYLE	TITLE		
		ANGULAR ±1/2°			DRAWN BY DATE GUZIK 1999/03/11	MICRO-FIT (3.0) CONNECTOR FAMILY (INDEX DRAWING)		
		DRAFT WHERE APPLICABLE			CHECKED BY DATE EDGLEY 1999/03/11		MOLEX MOLEX INCORPORATED	
	MUST REMAIN WITHIN DIMENSIONS			APPROVED BY DATE EDGLEY 1999/03/11	MATERIAL NO. (DOCUMENT NO.) SEE CHART SDIN-43045-0001	SHEET NO. 1 OF 1		
				THIS DRAWING CONTAINS INFORMATION THAT IS PROPRIETARY TO MOLEX INCORPORATED AND SHOULD NOT BE USED WITHOUT WRITTEN PERMISSION				