

AT2117QR425ZS-VFS

SERIES

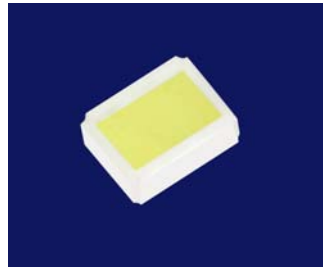

ATTENTION
OBSERVE PRECAUTIONS
FOR HANDLING
ELECTROSTATIC
DISCHARGE
SENSITIVE
DEVICES



Features

- Dimension: 2.15mmX 1.7mm X 0.8mm.
- Low thermal resistance.
- Ceramic package with silicone resin.
- Higher brightness LED flash.
- Small package with high efficiency.
- Surface mount technology.
- ESD protection.
- Radiation patterns optimal for camera flash.
- Enables higher resolution pictures in darken environments.
- Package : 2000pcs / reel.
- Moisture sensitivity level : level 2a.
- Soldering methods: IR reflow soldering.
- RoHS compliant.

Application Note

Static electricity and surge damage the LEDs.

It is recommended to use a wrist band or anti-electrostatic glove when handling the LEDs.

All devices, equipment and machinery must be electrically grounded.

Typical Applications

- Digital still cameras.
- Camera-phones.
- PDA's.
- Room lighting.
- Architectural lighting.
- Decorative/pathway lighting.
- Front panel backlight.

Package Dimensions

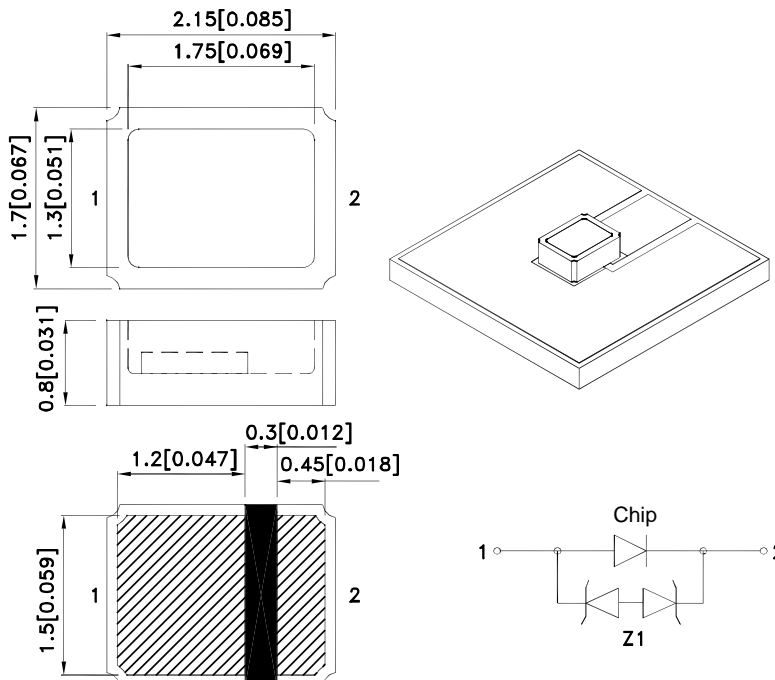

Notes:

1. All dimensions are in millimeters (inches).
2. Tolerance is $\pm 0.25(0.01)$ unless otherwise noted.
3. The specifications, characteristics and technical data described in the datasheet are subject to change without prior notice.
4. The device has a single mounting surface. The device must be mounted according to the specifications.



Absolute Maximum Ratings at T_A=25°C

Parameter	Symbol	Value	Unit
Operating Temperature	Top	-40 To +100	°C
Storage Temperature	Tstg	-40 To +110	°C
Junction temperature[1]	T _J	110	°C
DC Forward Current [1]	I _F	150	mA
Peak Forward Current [2]	I _{FM}	300	mA
Reverse Voltage	V _R	5	V
Power dissipation	P _D	0.6	W
Electrostatic Discharge Threshold (HBM)		8000	V
Thermal resistance [1] (Junction/ambient)	R _{th j-a}	170	°C/W
Thermal resistance [1] (Junction/solder point)	R _{th j-s}	55	°C/W

Notes:

- Results from mounting on PC board FR4, mounted on pc board-metal core PCB is recommend for lowest thermal resistance.
- 1/10 Duty Cycle, 0.1ms Pulse Width.

Electrical / Optical Characteristics at T_A=25°C

Parameter	Symbol	Value	Unit	
Forward Voltage I _F = 150mA [Min.]	V _F [1]	2.7	V	
Forward Voltage I _F = 150mA [Typ.]		3.5		
Forward Voltage I _F = 150mA [Max.]		4.0		
Reverse Current	I _R	10	μ A	
Optical efficiency	η _{opt}	AT2117QR425ZS-VFS-C1	62.86	lm/W
		AT2117QR425ZS-VFS-N1	55.24	
		AT2117QR425ZS-VFS-N2	59.05	
		AT2117QR425ZS-VFS-W1	47.62	
		AT2117QR425ZS-VFS-W2	49.52	
		AT2117QR425ZS-VFS-W3	51.43	
Temperature coefficient of x I _F = 150mA, -10 ° C ≤ T ≤ 100 ° C [Typ.]	TC _x	-0.15	10 ⁻³ /° C	
Temperature coefficient of y I _F = 150mA, -10 ° C ≤ T ≤ 100 ° C [Typ.]	TC _y	-0.13	10 ⁻³ /° C	
Temperature coefficient of V _F I _F = 150mA, -10 ° C ≤ T ≤ 100 ° C [Typ.]	TC _v	-3.1	mV/° C	

Note:

- Forward voltage is measured with a current pulse of 10ms at a tolerance of ±0.1V.

Selection Guide

Part No.	Color	CCT Range (K)			Lens Type	Luminous Intensity [2] Iv(cd)@ 150mA		Φv (lm) [3] @ 150mA	Viewing Angle [1]
		Min.	Typ.	Max.		Min.	Typ.	Typ.	2θ1/2
AT2117QR425ZS-VFS-C1	Cool White	5310	6000	7040	WATER CLEAR	5.7	8.3	33	120 °
AT2117QR425ZS-VFS-N1	Neutral White	3710	4000	4260	WATER CLEAR	4.7	7.7	29	120 °
AT2117QR425ZS-VFS-N2	Neutral White	4260	4700	5310	WATER CLEAR	5.7	8.0	31	120 °
AT2117QR425ZS-VFS-W1	Warm White	2580	2700	2870	WATER CLEAR	3.8	6.7	25	120 °
AT2117QR425ZS-VFS-W2	Warm White	2870	3000	3220	WATER CLEAR	3.8	7	26	120 °
AT2117QR425ZS-VFS-W3	Warm White	3220	3500	3710	WATER CLEAR	4.7	7.5	27	120 °

Brightness codes

ERP	Part No.	luminous Intensity [2] Iv(cd) @ 150mA			Φv (lm) [3] @ 150mA
		Code.	Min.	Max.	Typ.
1212000212	AT2117QR425ZS-VFS-C1	ZE	5.7	7.5	24
		ZF	6.7	8.5	30
		ZG	7.5	10	35
		ZH	8	12	40
1212000213	AT2117QR425ZS-VFS-N1	ZD	4.7	6.5	20
		ZE	5.7	7.5	25
		ZF	6.7	8.5	30
		ZG	7.5	10	35
1212000214	AT2117QR425ZS-VFS-N2	ZE	5.7	7.5	24
		ZF	6.7	8.5	30
		ZG	7.5	10	35
		ZH	8	12	38
1212000215	AT2117QR425ZS-VFS-W1	ZC	3.8	5.5	17
		ZD	4.7	6.5	25
		ZE	5.7	7.5	30
		ZF	6.7	8.5	35
1212000216	AT2117QR425ZS-VFS-W2	ZC	3.8	5.5	17
		ZD	4.7	6.5	25
		ZE	5.7	7.5	30
		ZF	6.7	8.5	35
1212000217	AT2117QR425ZS-VFS-W3	ZD	4.7	6.5	20
		ZE	5.7	7.5	25
		ZF	6.7	8.5	30
		ZG	7.5	10	35

Notes:

- 1.θ 1/2 is the angle from optical centerline where the luminous intensity is 1/2 of the optical peak value.
- 2.Luminous intensity is measured by a current pulse of 10ms at a tolerance of ±15%.
- 3.The typical data of Luminous Flux can only reflect statistical figures, actual parameters of individual product could differ from the typical data.
For the purpose of product enhancement, the typical data is subject to change without prior notice.
Shipment may contain more than one of the light intensity groups.
Orders for single light intensity group are generally not accepted.

CCT 2500-7000 K Bin Code

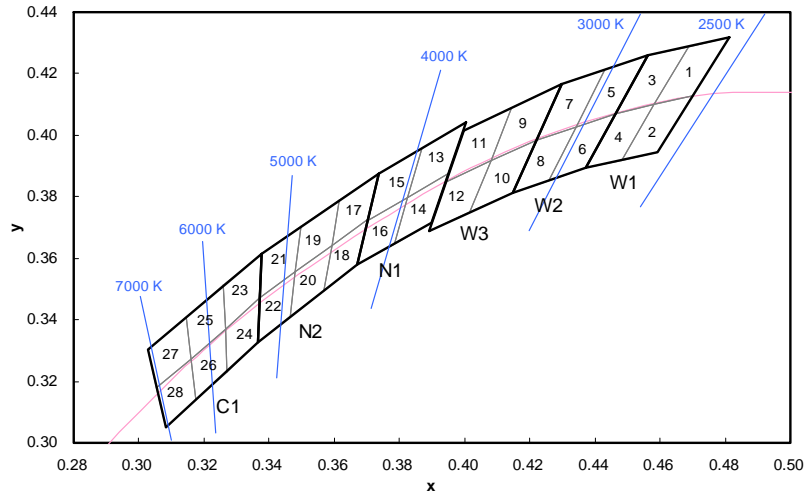

Color	Group	Chromaticity Regions	CCT (K)		
			Min.	Typ.	Max.
Warm White	W1	1, 2, 3, 4	2580	2700	2870
	W2	5, 6, 7, 8	2870	3000	3220
	W3	9, 10, 11, 12	3220	3500	3710
Neutral White	N1	13, 14, 15, 16	3710	4000	4260
	N2	17, 18, 19, 20, 21, 22	4260	4700	5310
Cool White	C1	23, 24, 25, 26, 27, 28	5310	6000	7040

Notes:
 Shipment may contain more than one chromaticity regions.
 Orders for single chromaticity region are generally not accepted.
 Measurement tolerance of the chromaticity coordinates is ± 0.01 .

	x	y		x	y		x	y		x	y
1	0.4582	0.4099	8	0.4147	0.3814	15	0.3702	0.3722	22	0.3481	0.3557
	0.4687	0.4289		0.4221	0.3984		0.3736	0.3874		0.3370	0.3472
	0.4813	0.4319		0.4342	0.4028		0.3869	0.3958		0.3364	0.3328
	0.4700	0.4126		0.4259	0.3853		0.3825	0.3798		0.3466	0.3411
2	0.4483	0.3919	9	0.4080	0.3916	16	0.3670	0.3578	23	0.3376	0.3616
	0.4582	0.4099		0.4146	0.4089		0.3702	0.3722		0.3260	0.3512
	0.4700	0.4126		0.4299	0.4165		0.3825	0.3798		0.3265	0.3371
	0.4593	0.3944		0.4221	0.3984		0.3783	0.3646		0.3370	0.3472
3	0.4465	0.4071	10	0.4017	0.3751	17	0.3736	0.3874	24	0.3370	0.3472
	0.4562	0.4260		0.4080	0.3916		0.3616	0.3788		0.3265	0.3371
	0.4687	0.4289		0.4221	0.3984		0.3592	0.3641		0.3270	0.3230
	0.4582	0.4099		0.4147	0.3814		0.3703	0.3726		0.3364	0.3328
4	0.4373	0.3893	11	0.3941	0.3848	18	0.3703	0.3726	25	0.3260	0.3512
	0.4465	0.4071		0.3996	0.4015		0.3592	0.3641		0.3144	0.3408
	0.4582	0.4099		0.4146	0.4089		0.3568	0.3495		0.3160	0.3274
	0.4483	0.3919		0.4080	0.3916		0.3670	0.3578		0.3265	0.3371
5	0.4342	0.4028	12	0.3889	0.3690	19	0.3616	0.3788	26	0.3265	0.3371
	0.4430	0.4212		0.3941	0.3848		0.3496	0.3702		0.3160	0.3274
	0.4562	0.4260		0.4080	0.3916		0.3481	0.3557		0.3175	0.3139
	0.4465	0.4071		0.4017	0.3751		0.3592	0.3641		0.3270	0.3230
6	0.4259	0.3853	13	0.3825	0.3798	20	0.3592	0.3641	27	0.3144	0.3408
	0.4342	0.4028		0.3869	0.3958		0.3481	0.3557		0.3028	0.3304
	0.4465	0.4071		0.4006	0.4044		0.3466	0.3411		0.3055	0.3177
	0.4373	0.3893		0.3950	0.3875		0.3568	0.3495		0.3160	0.3274
7	0.4221	0.3984	14	0.3783	0.3646	21	0.3496	0.3702	28	0.3160	0.3274
	0.4299	0.4165		0.3825	0.3798		0.3376	0.3616		0.3055	0.3177
	0.4430	0.4212		0.3950	0.3875		0.3370	0.3472		0.3081	0.3049
	0.4342	0.4028		0.3898	0.3716		0.3481	0.3557		0.3175	0.3139

Forward Voltage Groups

Forward Voltage		Unit
Min.	Max.	
2.7	2.9	V
2.9	3.1	V
3.1	3.3	V
3.3	3.6	V
3.6	3.9	V
3.9	4.1	V

Notes:

Forward voltage is measured with a current pulse of 10ms at a tolerance of $\pm 0.1V$.

Shipment may contain more than one of the forward voltage groups.

Orders for single forward voltage group are generally not accepted.

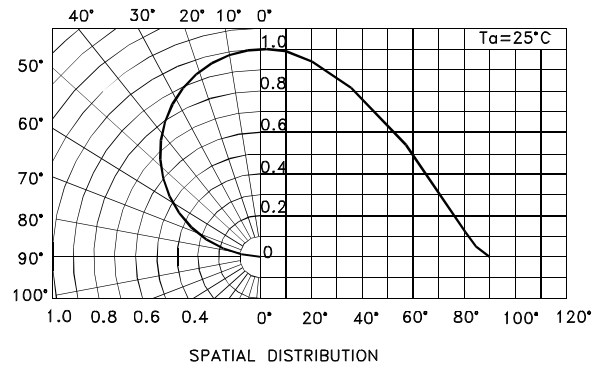

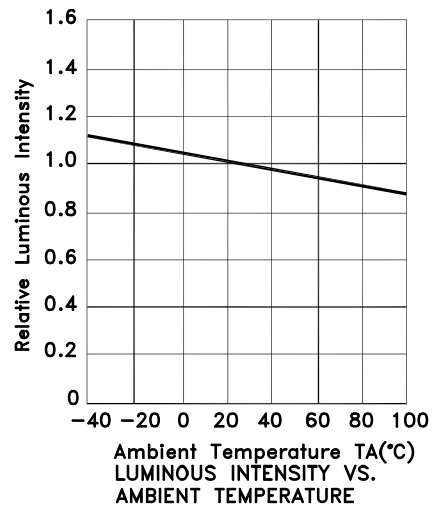
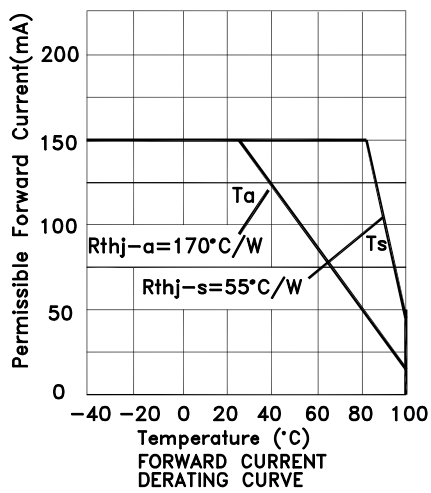
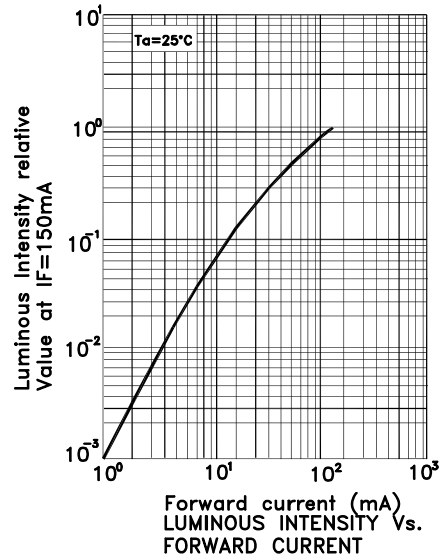
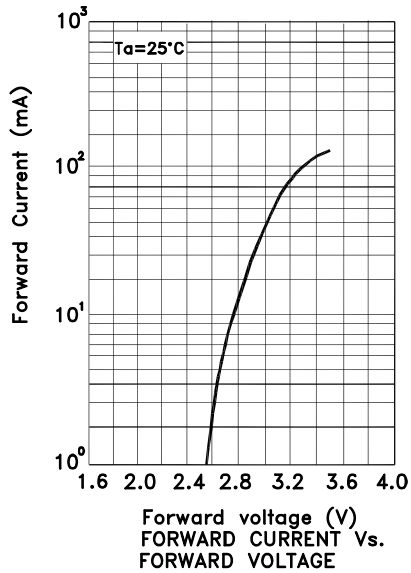

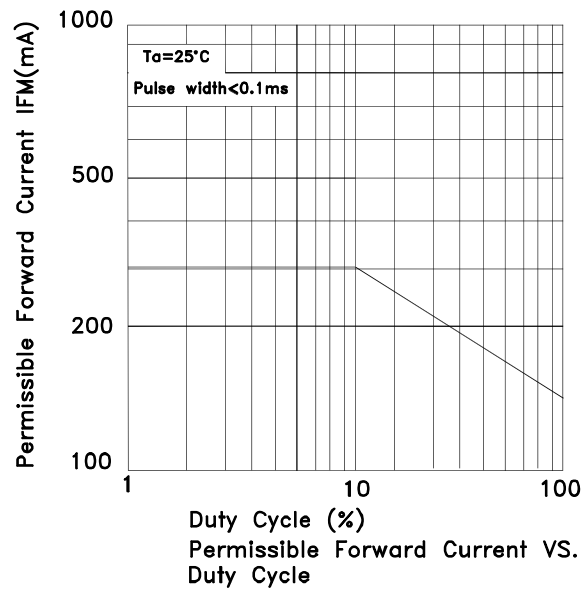
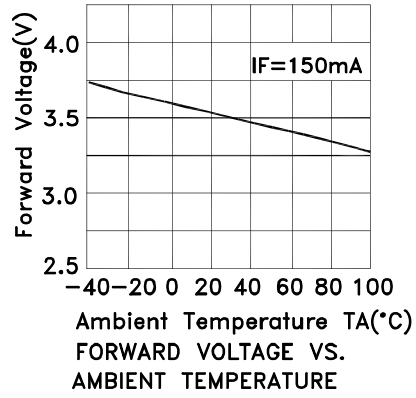

AT2117QR425ZS-VFS-C1

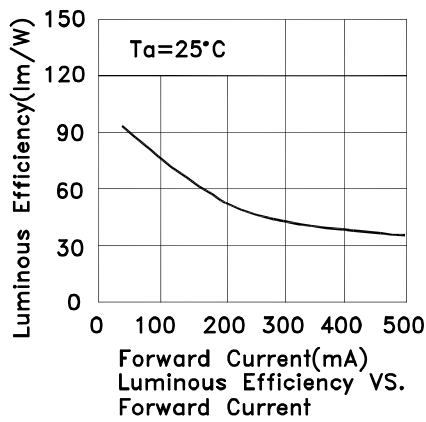

AT2117QR425ZS-VFS-N1

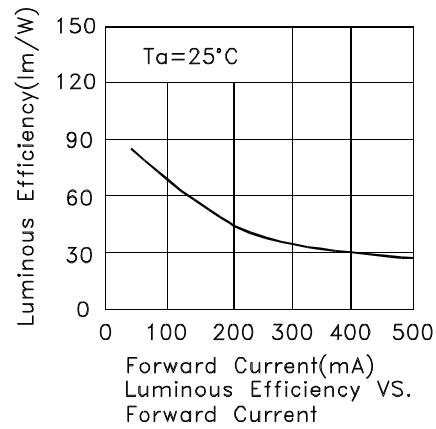

AT2117QR425ZS-VFS-N2

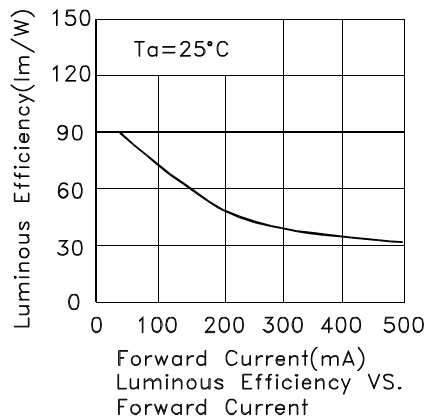

AT2117QR425ZS-VFS-W1

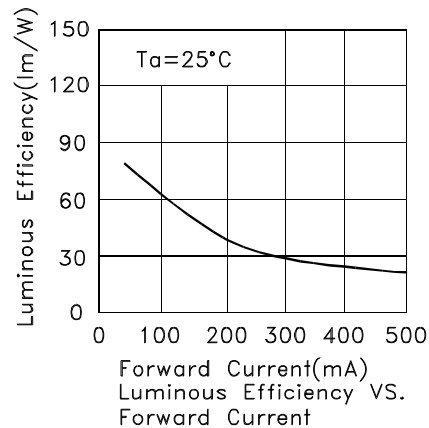

AT2117QR425ZS-VFS-W2

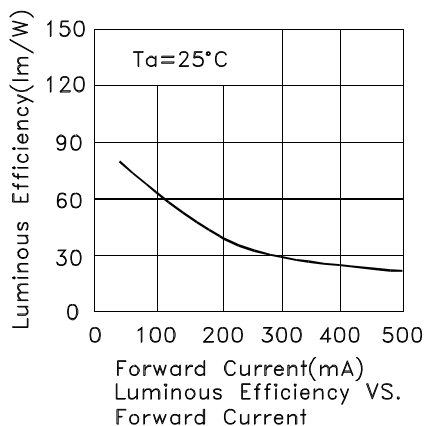

AT2117QR425ZS-VFS-W3

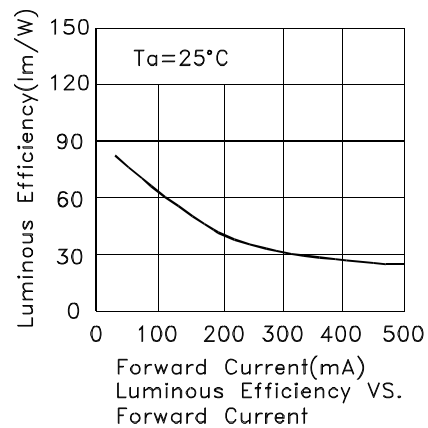

Reflow soldering is recommended and the soldering profile is shown below. Other soldering methods are not recommended as they might cause damage to the product.

Recommended Soldering Pattern (Units : mm; Tolerance: ± 0.1)

Reflow Soldering Profile For Lead-free SMT Process.

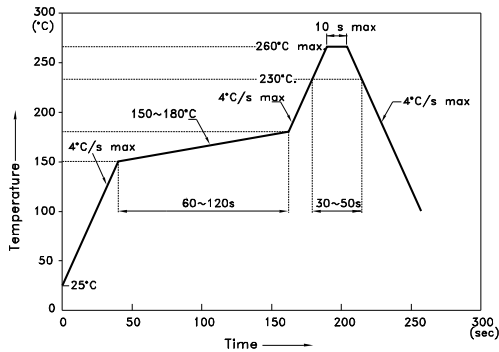

- NOTES:
1. We recommend the reflow temperature 245°C(+/-5°C). The maximum soldering temperature should be limited to 260°C.
 2. Don't cause stress to the epoxy resin while it is exposed to high temperature.
 3. Number of reflow process shall be 2 times or less.

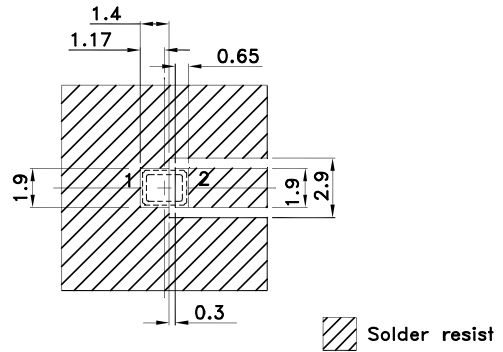

Reel Dimension

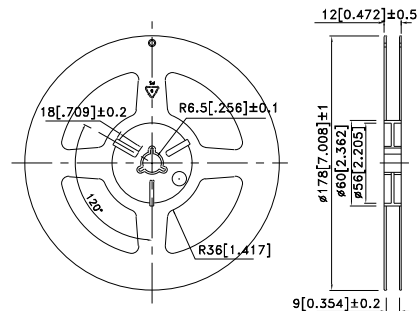

Heat Generation:

1. Thermal design of the end product is of paramount importance. Please consider the heat generation of the LED when making the system design. The coefficient of temperature increase per input electric power is affected by the thermal resistance of the circuit board and density of LED placement on the board, as well as other components. It is necessary to avoid intense heat generation and operate within the maximum ratings given in this specification.

2. Please determine the operating current with consideration of the ambient temperature local to the LED and refer to the plot of Permissible Forward current vs. Ambient temperature on CHARACTERISTICS in this specification. Please also take measures to remove heat from the area near the LED to improve the operational characteristics on the LED.

3. The equation ① indicates correlation between T_j and T_a , and the equation ② indicates correlation between T_j and T_s

$$T_j = T_a + R_{thj-a} * W \quad \text{①}$$

$$T_j = T_s + R_{thj-s} * W \quad \text{②}$$

T_j = dice junction temperature: °C

T_a = ambient temperature: °C

T_s = solder point temperature: °C

R_{thj-a} = heat resistance from dice junction temperature to ambient temperature : °C / W

R_{thj-s} = heat resistance from dice junction temperature to T_s measuring point : °C / W

W = inputting power (IFx VF) : W

Kingbright

Tape Specifications (Units : mm)

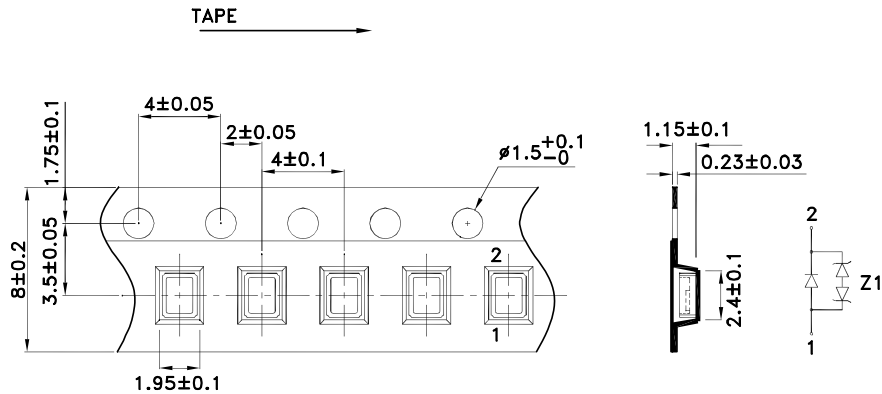

PACKING & LABEL SPECIFICATIONS

AT2117QR425ZS-VFS SERIES

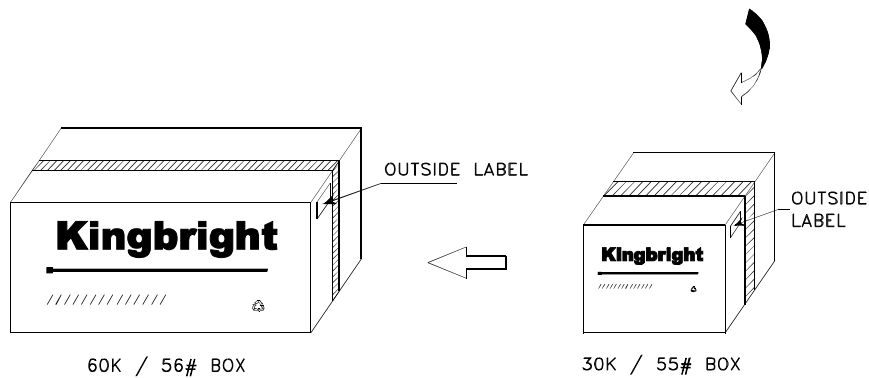
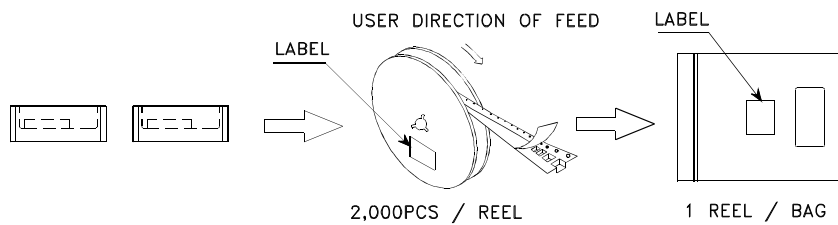

Kingbright	
P/NO: AT2117xxx	
QTY: 2,000 pcs	Q.C. Q C XX XX XXXX PASSED
S/N: XXXX	
CODE: XXX	VF:xxV-xxV
LOT NO:	
	
RoHS Compliant	

Handling Precautions

Compare to epoxy encapsulant that is hard and brittle, silicone is softer and flexible. Although its characteristic significantly reduces thermal stress, it is more susceptible to damage by external mechanical force.

As a result, special handling precautions need to be observed during assembly using silicone encapsulated LED products. Failure to comply might leads to damage and premature failure of the LED.

1. Handle the component along the side surfaces by using forceps or appropriate tools.

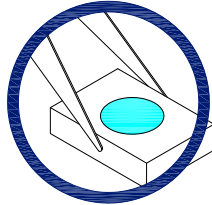

2. Do not directly touch or handle the silicone lens surface. It may damage the internal circuitry.

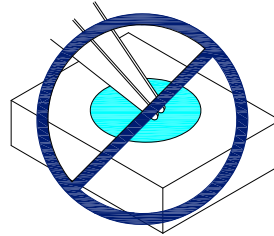
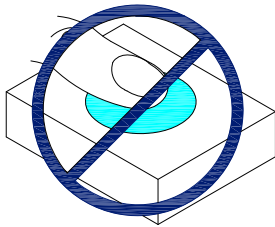

3. Do not stack together assembled PCBs containing exposed LEDs. Impact may scratch the silicone lens or damage the internal circuitry.

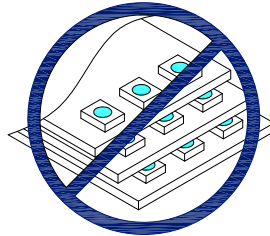

4. The outer diameter of the SMD pickup nozzle should not exceed the size of the LED to prevent air leaks. The inner diameter of the nozzle should be as large as possible.
5. A pliable material is suggested for the nozzle tip to avoid scratching or damaging the LED surface during pickup.
6. The dimensions of the component must be accurately programmed in the pick-and-place machine to insure precise pickup and avoid damage during production.

