

APPLICATION MANUAL

www.DataSheet4U.com

CMOS LDO Regulator IC TK631xxB/H/S

CONTENTS

1 . DESCRIPTION	2
2 . FEATURES	2
3 . APPLICATIONS	2
4 . PIN CONFIGURATION	2
5 . BLOCK DIAGRAM	2
6 . ORDERING INFORMATION	3
7 . ABSOLUTE MAXIMUM RATINGS	3
8 . ELECTRICAL CHARACTERISTICS	4
9 . TEST CIRCUIT	7
10 . TYPICAL CHARACTERISTICS	9
11 . PIN DESCRIPTION	26
12 . APPLICATIONS INFORMATION	27
13 . PACKAGE OUTLINE	32
14 . NOTES	35
15 . OFFICES	35



CMOS LDO Regulator TK631xxB/H/S

1. DESCRIPTION

The TK631xxB/H/S is a CMOS LDO regulator. The packages are the very small 4-bump flip chip, the small and thin SON2017-6, and the extremely versatile SOT23-5.

The IC is designed for portable applications with space requirements, battery powered system and any electronic equipment.

The IC does not require a noise-bypass capacitor.

The IC offers high accuracy ($\pm 1\%$) and low dropout voltage.

The output voltage is internally fixed from 1.5V to 4.2V.

2. FEATURES

- High accuracy ($\pm 1\%$)
- Packages: FC-4 / SON2017-6 / SOT23-5
- No noise bypass capacitor required
- Low dropout voltage
- Thermal and over current protection
- High maximum load current
- On/Off control

3. APPLICATIONS

- Mobile Communication
- Battery Powered System
- Any Electronic Equipment

4. PIN CONFIGURATION

- FC-4 (TK631xxB)

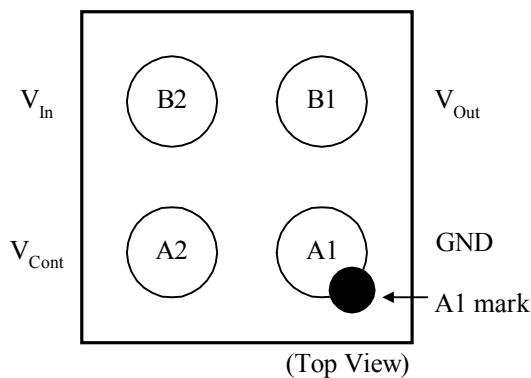

- SON2017-6 (TK631xxH)

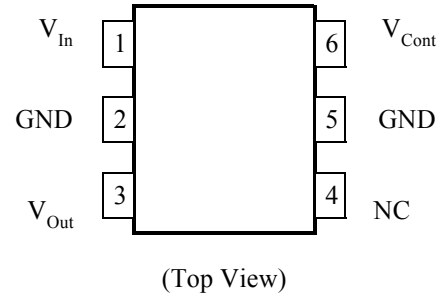

- SOT23-5 (TK631xxS)

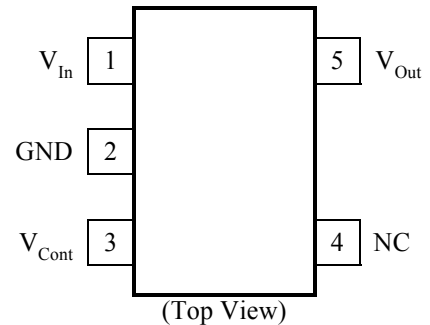

5. BLOCK DIAGRAM

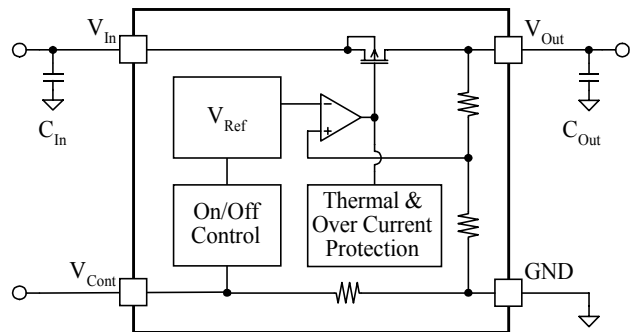

6. ORDERING INFORMATION

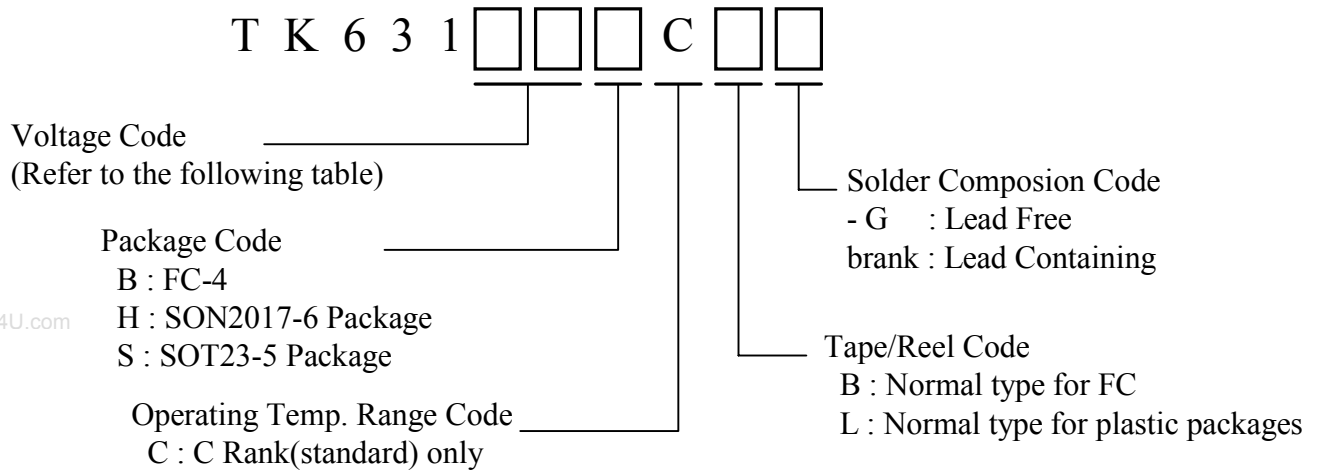

Output Voltage	Voltage Code	Output Voltage	Voltage Code	Output Voltage	Voltage Code
1.5V	15	2.8V	28	3.3V	33
1.6V	16	2.85 V	01	3.5V	35
1.8V	18	2.9V	29		
2.5V	25	3.0V	30		
2.6V	26	3.1V	31		
2.7V	27	3.2V	32		

*If you need a voltage other than the value listed in the above table, please contact TOKO.

7. ABSOLUTE MAXIMUM RATINGS

T_a=25°C

Parameter	Symbol	Rating	Units	Conditions
Absolute Maximum Ratings				
Input Voltage	V _{In,MAX}	-0.3 ~ 7.0	V	
Output pin Voltage	V _{Out,MAX}	-0.3 ~ V _{In} +0.3	V	
Control pin Voltage	V _{Cont,MAX}	-0.3 ~ 7.0	V	
Storage Temperature Range	T _{stg}	-55 ~ 150	°C	
Power Dissipation	P _D	360 500	mW	Internal Limited T _j =150°C *, When mounted on PCB FC-4 SON2017-6 , SOT23-5
Operating Condition				
Operational Temperature Range	T _{OP}	-40 ~ 85	°C	
Operational Voltage Range	V _{OP}	2.0 ~ 6.0	V	

* P_D must be decreased at the rate of 2.9mW/°C (FC-4) or 4mW/°C (SON2017-6 , SOT23-5) for operation above 25°C. The maximum ratings are the absolute limitation values with the possibility of the IC breakage. When the operation exceeds this standard quality can not be guaranteed.

8. ELECTRICAL CHARACTERISTICS

The parameters with min. or max. values will be guaranteed at $T_a=T_j=25^{\circ}\text{C}$ with test when manufacturing or SQC(Statistical Quality Control) methods. The operation between $-40 \sim 85^{\circ}\text{C}$ is guaranteed when design.

$$V_{In}=V_{Out,TYP}+1V, V_{Cont}=1.3V, T_a=T_j=25^{\circ}\text{C}$$

Parameter	Symbol	Value			Units	Conditions
		MIN	TYP	MAX		
Output Voltage	V_{Out}	Refer to TABLE 1			V	$I_{Out}=5\text{mA}$
Line Regulation	LinReg	-	0.0	4.0	mV	$\Delta V_{In}=1V$
Load Regulation	LoaReg	Refer to TABLE 2			mV	Refer to TABLE 2
Dropout Voltage *1	V_{Drop}	Refer to TABLE 2			mV	Refer to TABLE 2
Maximum Load Current *2	$I_{Out,MAX}$	210	300	-	mA	$V_{Out}=V_{Out,TYP}\times 0.9$
Quiescent Current	I_Q	-	80	120	μA	$I_{Out}=0\text{mA}, V_{Cont}=V_{In}$
Standby Current	$I_{Standby}$	-	0.01	0.1	μA	$V_{Cont}=0V$
GND Pin Current	I_{GND}	-	90	150	μA	$I_{Out}=50\text{mA}, V_{Cont}=V_{In}$
Control Terminal						
Control Current	I_{Cont}	-	2.0	4.0	μA	$V_{Cont}=1.3V$
Control Voltage	V_{Cont}	1.3	-	-	V	V_{Out} On state
		-	-	0.25	V	V_{Out} Off state

Reference Value						
Output Voltage / Temp.	$\Delta V_{Out}/\Delta T_a$	-	100	-	ppm/ $^{\circ}\text{C}$	$I_{Out}=5\text{mA}$
Output Noise Voltage (TK63128)	V_{Noise}	-	40	-	μV_{rms}	$C_{Out}=1.0\mu\text{F}, I_{Out}=30\text{mA}, \text{BPF}=400\text{Hz}\sim 80\text{kHz}$
Ripple Rejection (TK63128)	RR	-	70	-	dB	$C_{Out}=1.0\mu\text{F}, I_{Out}=10\text{mA}, f=1\text{kHz}$
Rise Time (TK63128)	t_r	-	30	-	μs	$C_{Out}=1.0\mu\text{F}, V_{Cont}$: Pulse Wave (100Hz), V_{Cont} On $\rightarrow V_{Out}\times 95\%$ point

*1: For $V_{Out} \leq 2.0V$, no regulations.

*2: The maximum output current is limited by power dissipation.

General Note

Parameters with only typical values are just reference. (Not guaranteed)

The noise level is dependent on the output voltage, the capacitance and capacitor characteristics.

TABLE 1. Preferred Product

Part Number	Output Voltage		
	MIN	TYP	MAX
	V	V	V
TK63115B/H/S	1.485	1.500	1.515
TK63116B/H/S	1.584	1.600	1.616
TK63118B/H/S	1.782	1.800	1.818
TK63125B/H/S	2.475	2.500	2.525
TK63126B/H/S	2.574	2.600	2.626
TK63127B/H/S	2.673	2.700	2.727
TK63128B/H/S	2.772	2.800	2.828
TK63101B/H/S	2.821	2.850	2.879
TK63129B/H/S	2.871	2.900	2.929
TK63130B/H/S	2.970	3.000	3.030
TK63131B/H/S	3.069	3.100	3.131
TK63132B/H/S	3.168	3.200	3.232
TK63133B/H/S	3.267	3.300	3.333
TK63135B/H/S	3.465	3.500	3.535

Notice.

Please contact your authorized TOKO representative for voltage availability.

TABLE 2. Preferred Product

Part Number	Load Regulation						Dropout Voltage					
	I _{Out} =5 ~ 100mA		I _{Out} =5 ~ 150mA		I _{Out} =5 ~ 200mA		I _{Out} =100mA		I _{Out} =150mA		I _{Out} =200mA	
	TYP	MAX	TYP	MAX	TYP	MAX	TYP	MAX	TYP	MAX	TYP	MAX
	mV	mV	mV	mV	mV	mV	mV	mV	mV	mV	mV	mV
TK63115B	4	16	6	24	8	32	155	-	235	-	315	-
TK63116B	4	16	6	24	8	32	150	-	220	-	295	-
TK63118B	4	16	6	24	8	32	130	-	195	-	280	-
TK63125B	4	16	6	24	9	36	95	145	155	220	280	380
TK63126B	4	16	6	24	9	36	90	140	155	210	280	380
TK63127B	4	16	6	24	9	36	85	135	155	205	280	380
TK63128B	4	16	6	24	9	36	85	130	155	195	280	380
TK63101B	4	16	6	24	9	36	80	130	155	195	280	380
TK63129B	4	16	6	24	9	36	80	125	155	195	280	380
TK63130B	4	16	6	24	9	36	80	125	155	195	280	380
TK63131B	4	16	7	28	9	36	80	125	155	195	280	380
TK63132B	4	16	7	28	9	36	80	125	155	195	280	380
TK63133B	4	16	7	28	9	36	80	125	155	195	280	380
TK63135B	4	16	7	28	9	36	80	125	155	195	280	380

Part Number	Load Regulation						Dropout Voltage					
	I _{Out} =5 ~ 100mA		I _{Out} =5 ~ 150mA		I _{Out} =5 ~ 200mA		I _{Out} =100mA		I _{Out} =150mA		I _{Out} =200mA	
	TYP	MAX	TYP	MAX	TYP	MAX	TYP	MAX	TYP	MAX	TYP	MAX
	mV	mV	mV	mV	mV	mV	mV	mV	mV	mV	mV	mV
TK63115H/S	9	36	15	60	20	80	180	-	260	-	340	-
TK63116H/S	9	36	15	60	20	80	160	-	240	-	320	-
TK63118H/S	9	36	15	60	20	80	135	-	205	-	300	-
TK63125H/S	9	36	15	60	20	80	105	160	175	260	300	420
TK63126H/S	9	36	15	60	20	80	105	155	170	255	300	420
TK63127H/S	9	36	15	60	20	80	100	150	180	265	300	420
TK63128H/S	9	36	15	60	20	80	100	145	180	265	300	420
TK63101H/S	9	36	15	60	20	80	95	140	180	265	300	420
TK63129H/S	9	36	15	60	20	80	95	140	180	265	300	420
TK63130H/S	9	36	15	60	20	80	95	140	180	265	300	420
TK63131H/S	9	36	15	60	20	80	95	140	180	265	300	420
TK63132H/S	9	36	15	60	20	80	95	140	180	265	300	420
TK63133H/S	9	36	15	60	20	80	95	140	180	265	300	420
TK63135H/S	9	36	15	60	20	80	95	140	180	265	300	420

9. TEST CIRCUIT

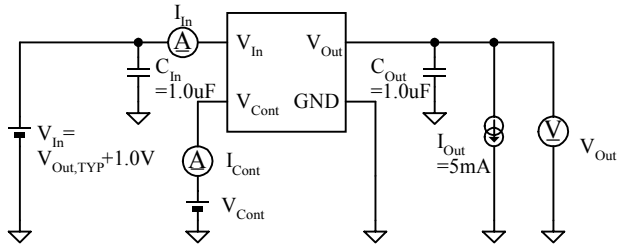

■ Test circuit for electrical characteristic

Notice.

The limit value of electrical characteristics is applied when $C_{In}=1.0\mu\text{F}$ (Ceramic), $C_{Out}=1.0\mu\text{F}$ (Ceramic). But C_{In} , and C_{Out} can be used with both ceramic and tantalum capacitors.

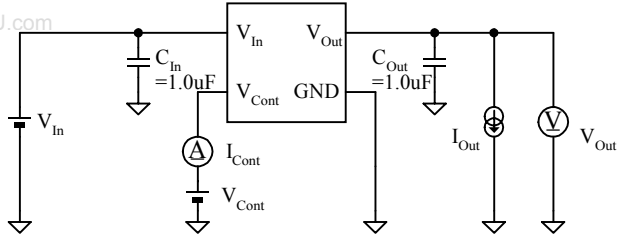

- ΔV_{Out} vs V_{In}
- V_{Drop} vs I_{Out}
- V_{Out} vs I_{Out}
- ΔV_{Out} vs I_{Out}
- ΔV_{Out} vs T_a
- V_{Drop} vs T_a
- $I_{Out,MAX}$ vs T_a
- I_{Cont} vs V_{Cont} , V_{Out} vs V_{Cont}
- I_{Cont} vs T_a
- V_{Cont} vs T_a
- V_{Noise} vs V_{In}
- V_{Noise} vs I_{Out}
- V_{Noise} vs V_{Out}
- V_{Noise} vs Frequency

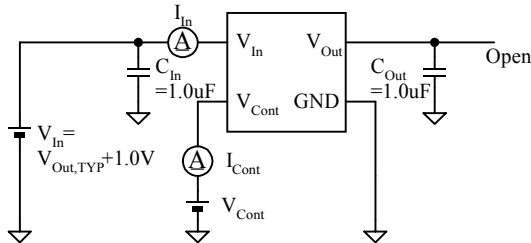

- I_Q vs V_{In}
- $I_{Standby}$ vs V_{In}
- I_Q vs T_a

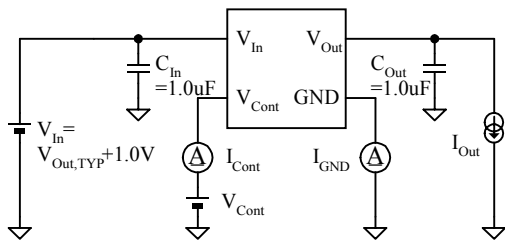

- I_{GND} vs I_{Out}
- I_{GND} vs T_a

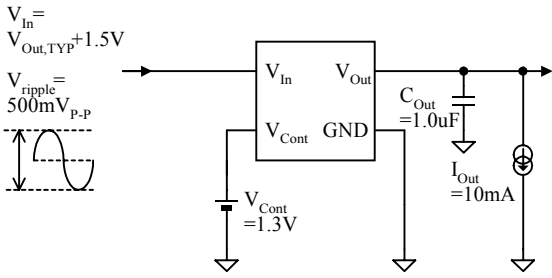

- RR vs V_{In}
- RR vs Frequency
- RR vs Frequency

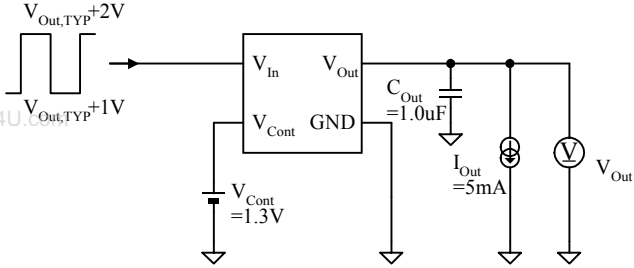

- Line Transient

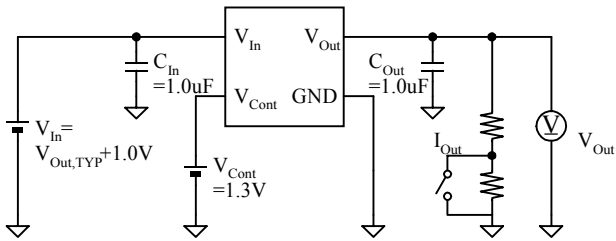

- Load Transient

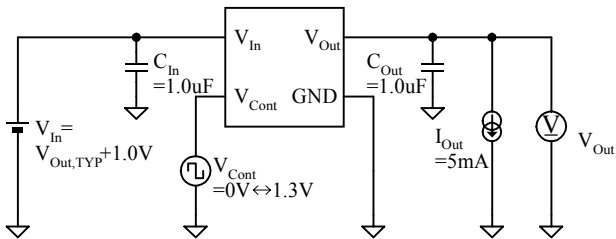

- On/Off Transient

10. TYPICAL CHARACTERISTICS

10-1. DC CHARACTERISTICS

■ ΔV_{Out} vs V_{In} (TK63115B/H/S)

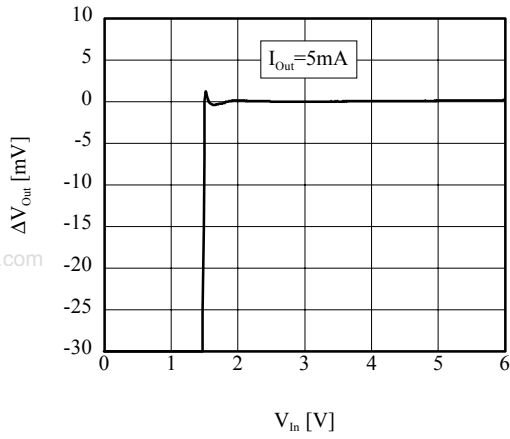

■ ΔV_{Out} vs V_{In} (TK63115B)

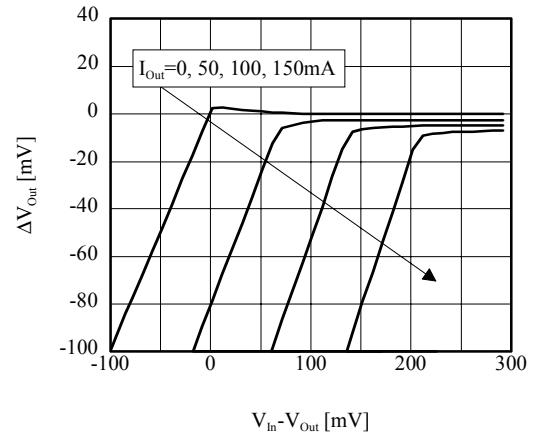

■ ΔV_{Out} vs V_{In} (TK63128B/H/S)

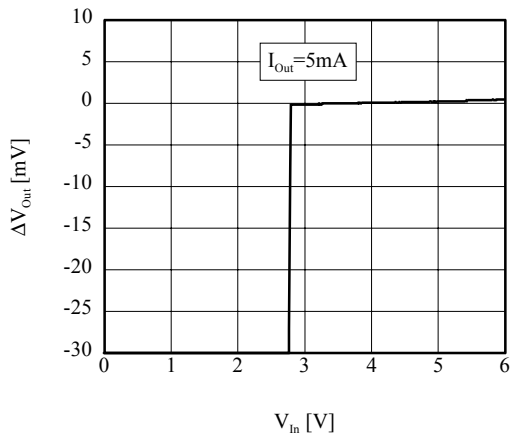

■ ΔV_{Out} vs V_{In} (TK63128B)

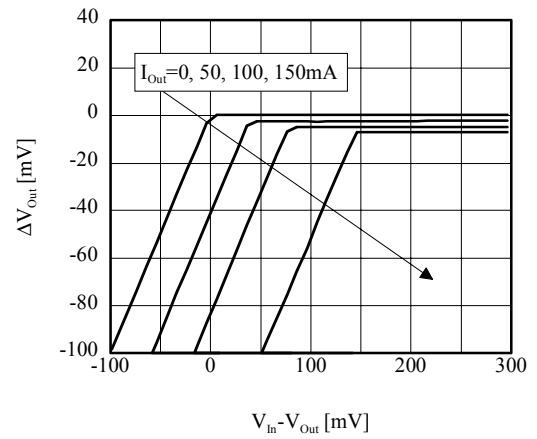

■ ΔV_{Out} vs V_{In} (TK63142B/H/S)

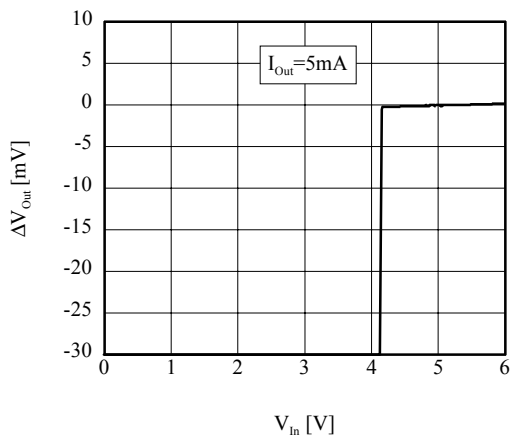

■ ΔV_{Out} vs V_{In} (TK63142B)

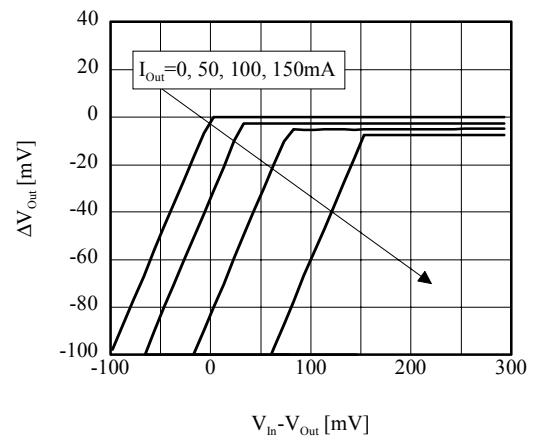

■ ΔV_{Out} vs V_{In} (TK63115H/S)

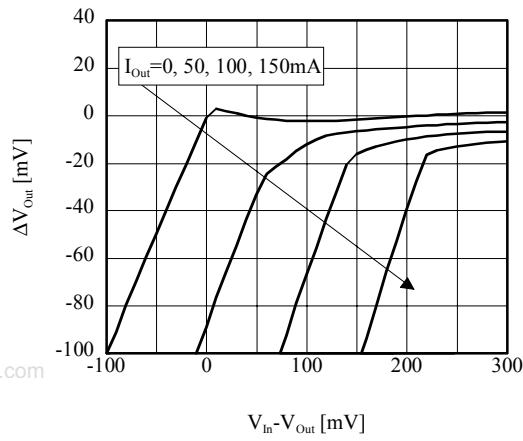

■ V_{Drop} vs I_{Out} (TK63115B)

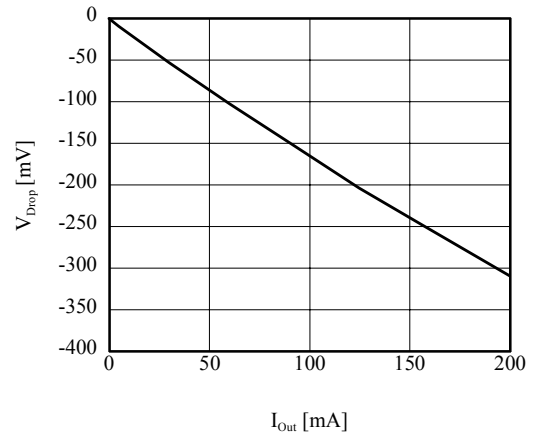

■ ΔV_{Out} vs V_{In} (TK63128H/S)

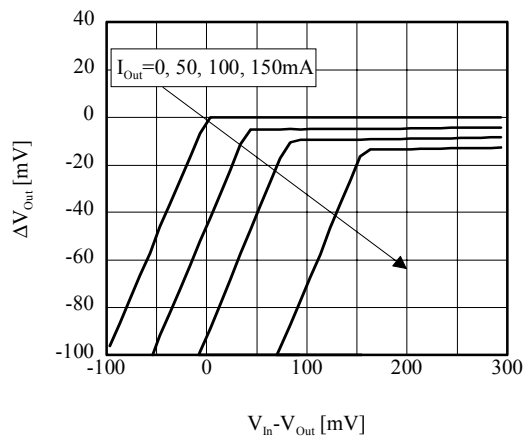

■ V_{Drop} vs I_{Out} (TK63128B)

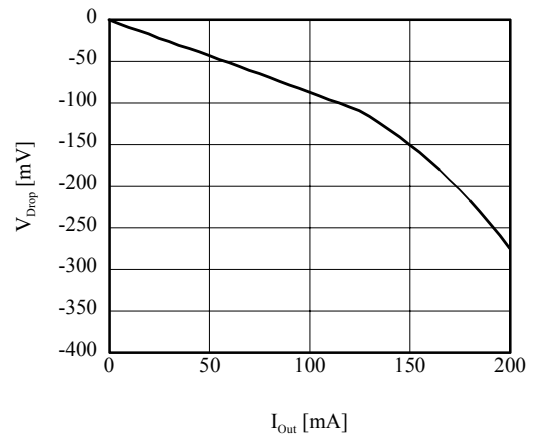

■ ΔV_{Out} vs V_{In} (TK63142H/S)

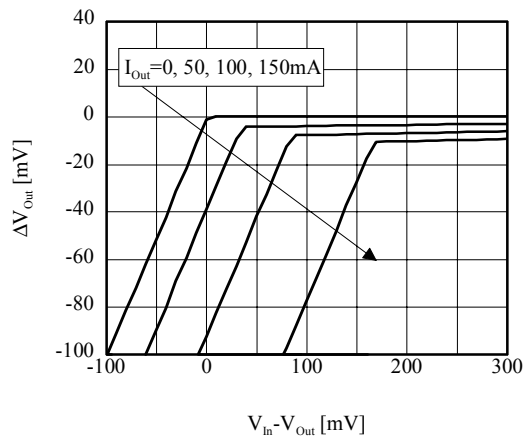

■ V_{Drop} vs I_{Out} (TK63142B)

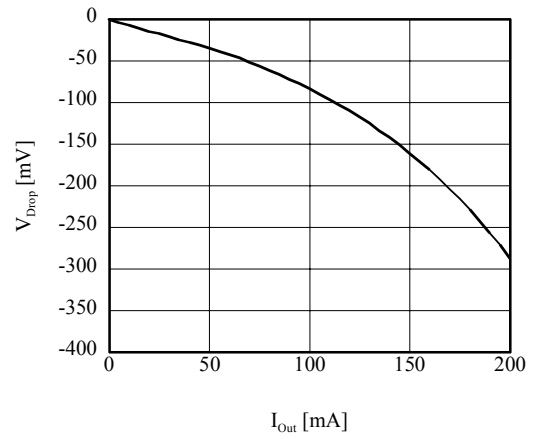

■ V_{Drop} vs I_{Out} (TK63115H/S)

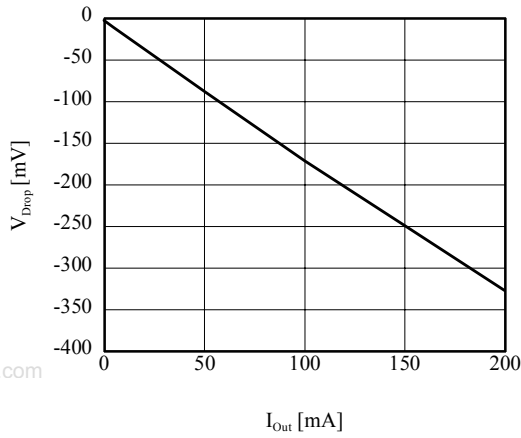

■ V_{Out} vs I_{Out} (TK63115B/H/S)

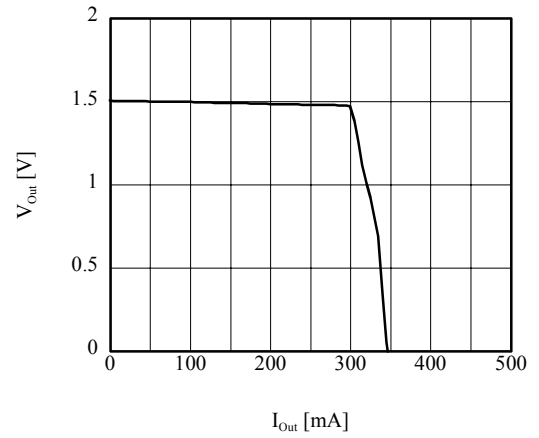

■ V_{Drop} vs I_{Out} (TK63128H/S)

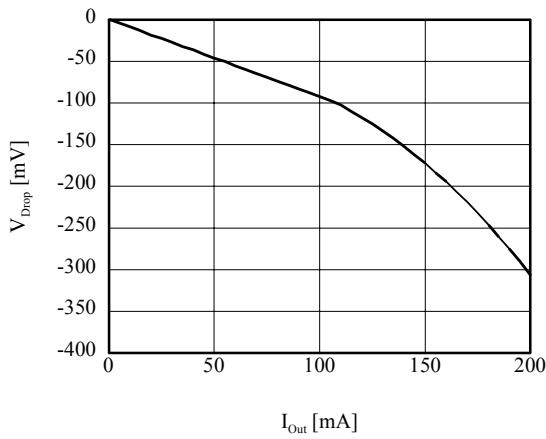

■ V_{Out} vs I_{Out} (TK63128B/H/S)

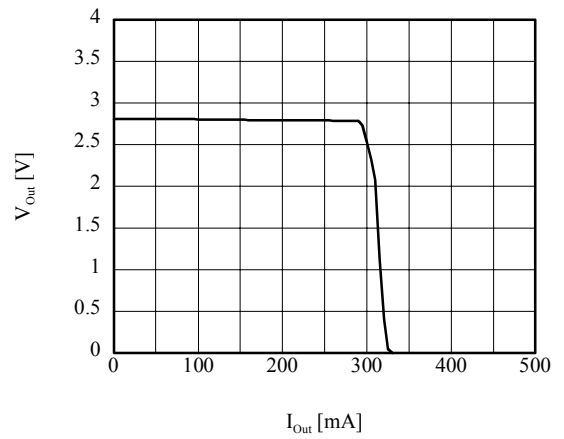

■ V_{Drop} vs I_{Out} (TK63142H/S)

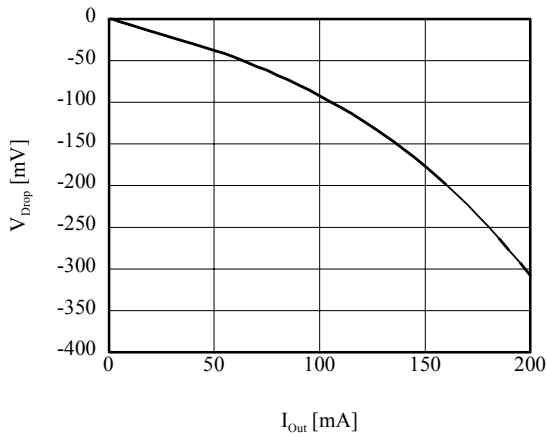

■ V_{Out} vs I_{Out} (TK63142B/H/S)

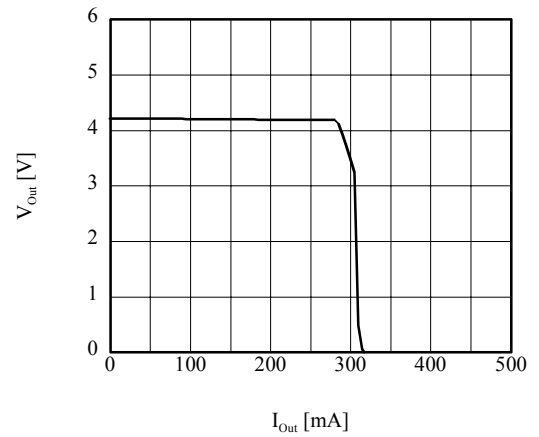

■ ΔV_{Out} vs I_{Out} (TK63115B)

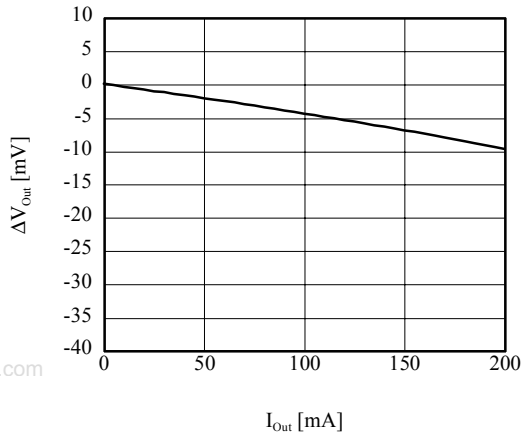

■ ΔV_{Out} vs I_{Out} (TK63115H/S)

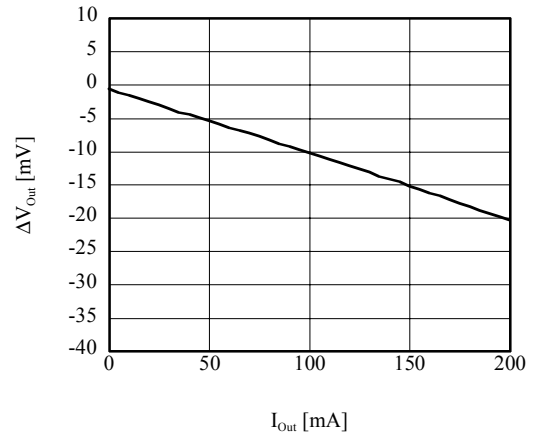

■ ΔV_{Out} vs I_{Out} (TK63128B)

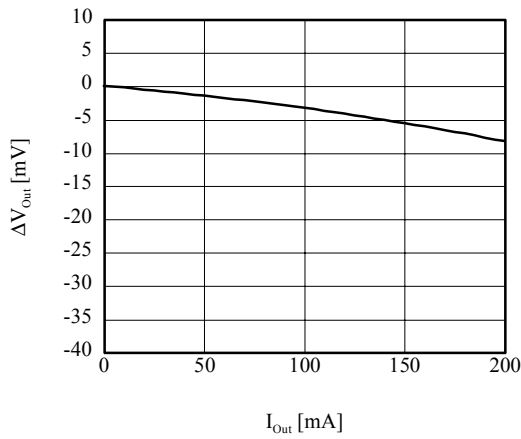

■ ΔV_{Out} vs I_{Out} (TK63128H/S)

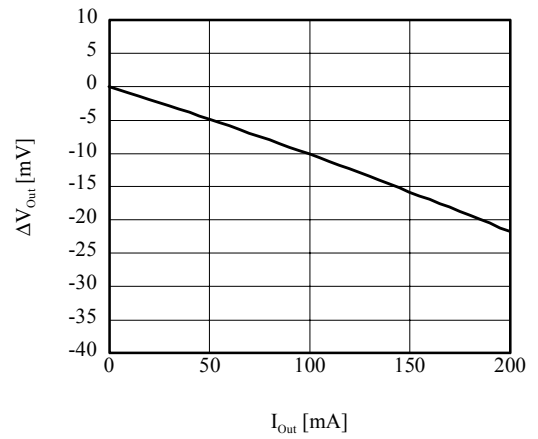

■ ΔV_{Out} vs I_{Out} (TK63142B)

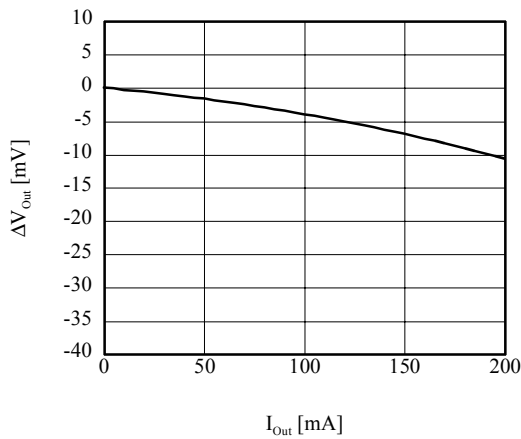

■ ΔV_{Out} vs I_{Out} (TK63142H/S)

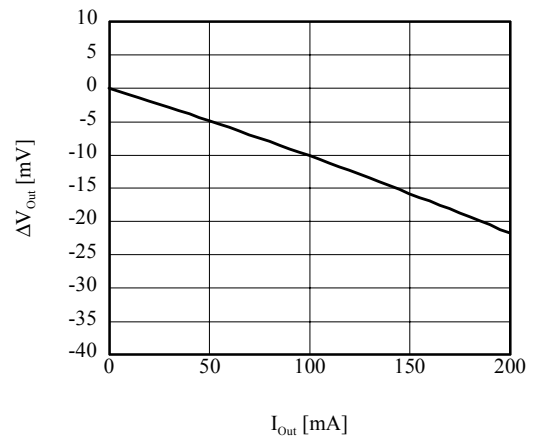

■ ΔV_{Out} vs T_a (TK63115B/H/S)

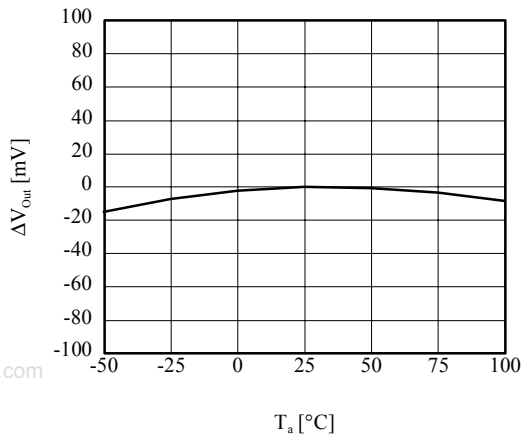

■ V_{Drop} vs T_a (TK63115B)

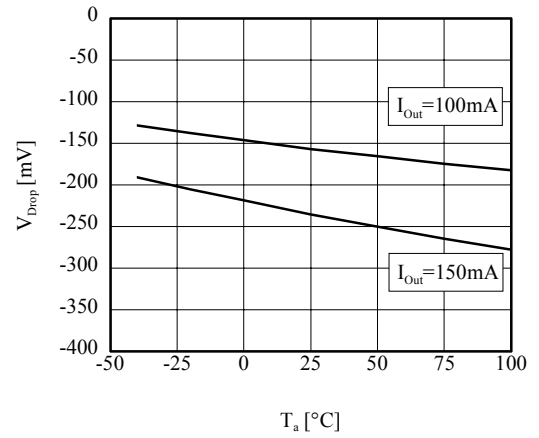

■ ΔV_{Out} vs T_a (TK63128B/H/S)

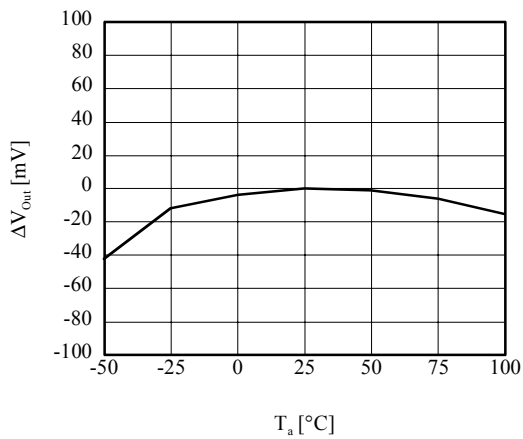

■ V_{Drop} vs T_a (TK63128B)

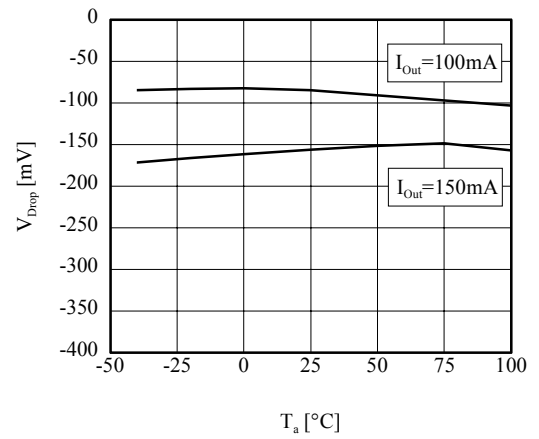

■ ΔV_{Out} vs T_a (TK63142B/H/S)

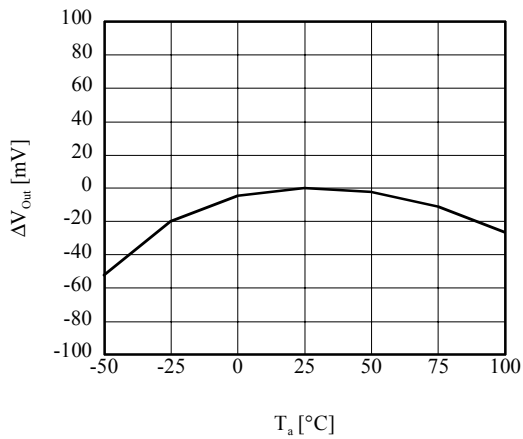

■ V_{Drop} vs T_a (TK63142B)

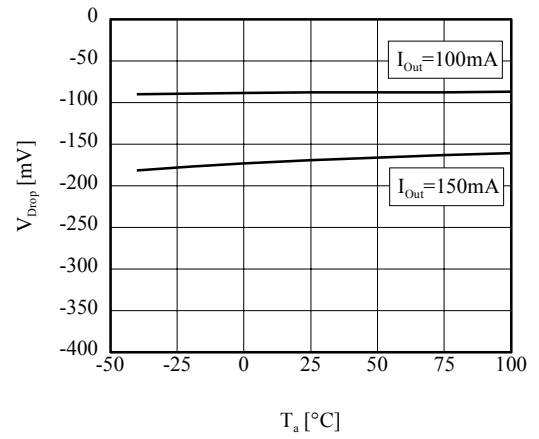

■ V_{Drop} vs T_a (TK63115H/S)

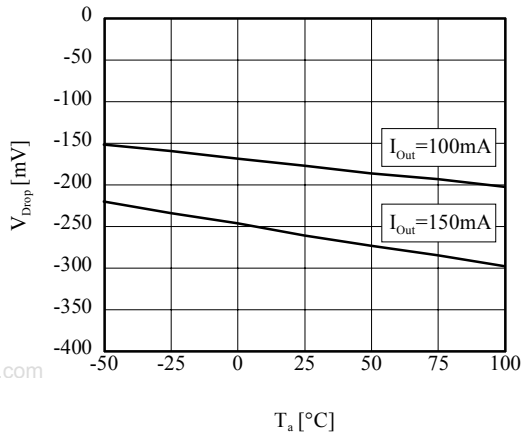

■ $I_{Out,MAX}$ vs T_a (TK63115B/H/S)

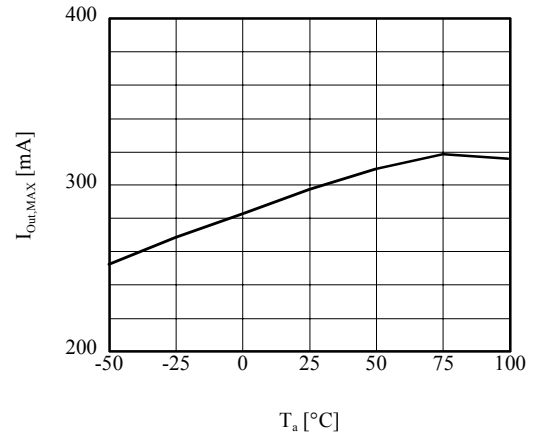

■ V_{Drop} vs T_a (TK63128H/S)

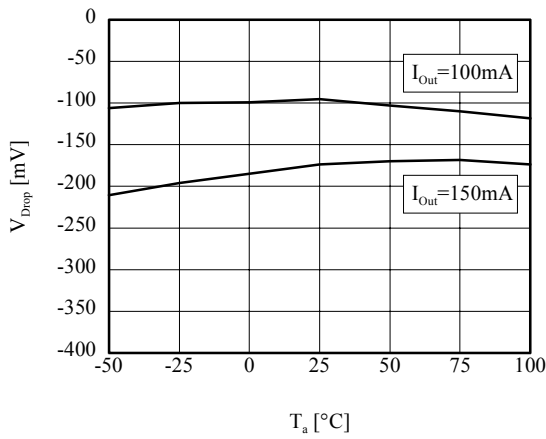

■ $I_{Out,MAX}$ vs T_a (TK63128B/H/S)

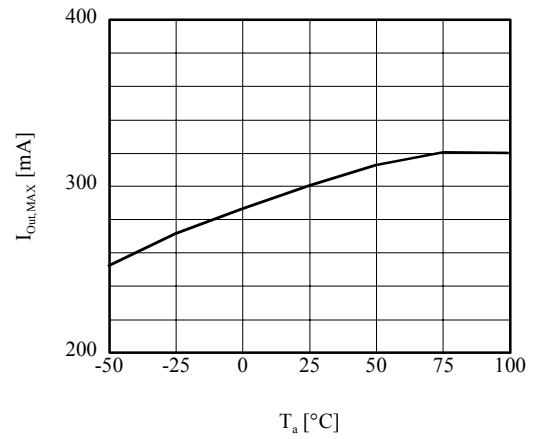

■ V_{Drop} vs T_a (TK63142H/S)

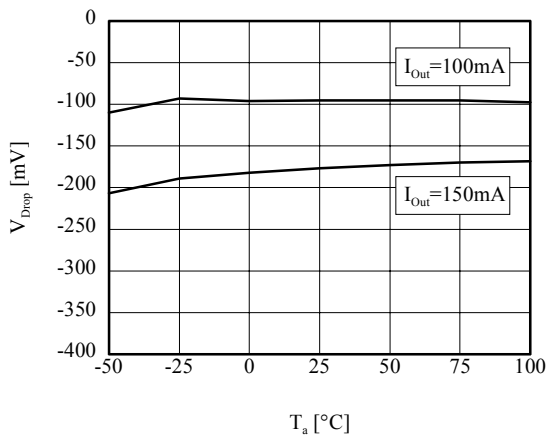

■ $I_{Out,MAX}$ vs T_a (TK63142B/H/S)

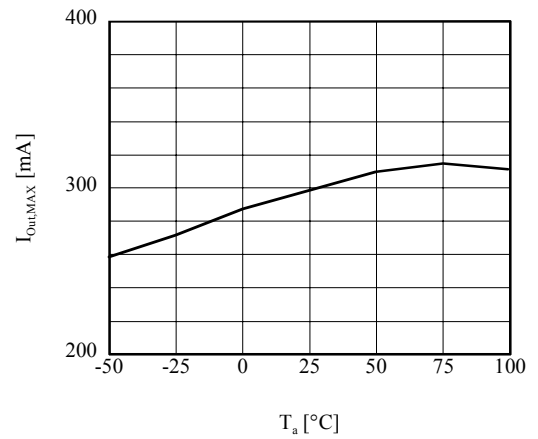

■ I_Q vs V_{In} (TK63115B/H/S)

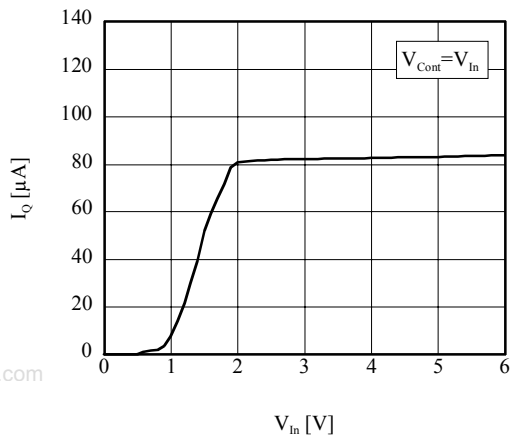

■ $I_{Standby}$ vs V_{In} (TK63115B/H/S)

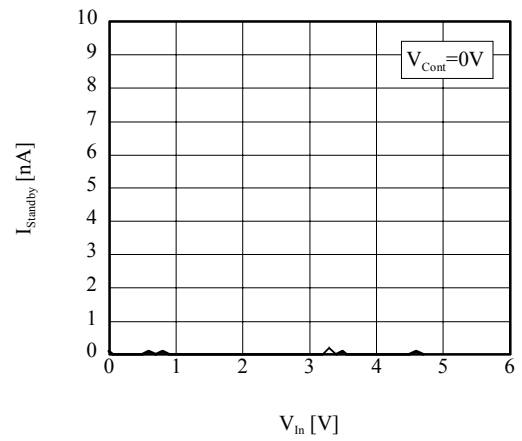

■ I_Q vs V_{In} (TK63128B/H/S)

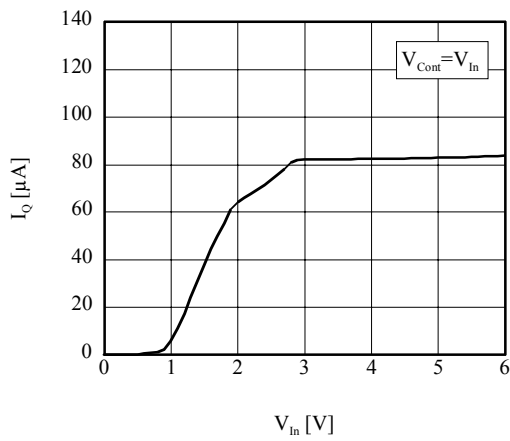

■ $I_{Standby}$ vs V_{In} (TK63128B/H/S)

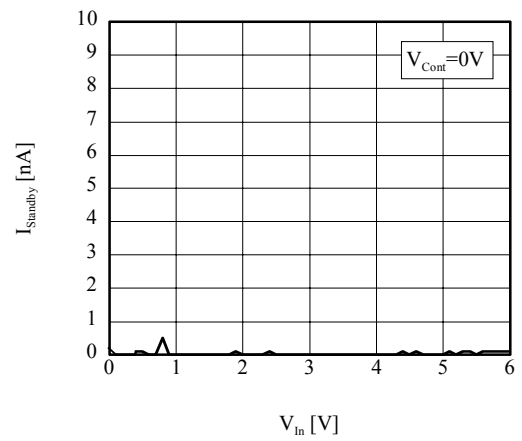

■ I_Q vs V_{In} (TK63142B/H/S)

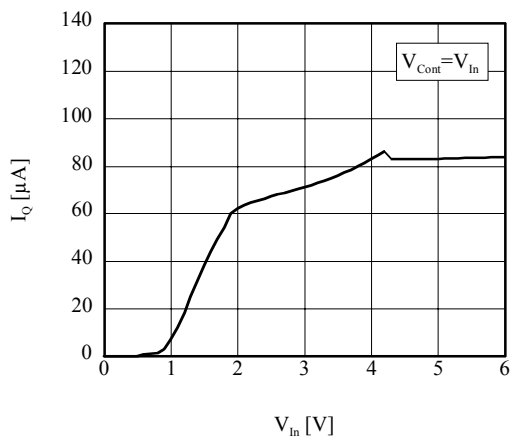

■ $I_{Standby}$ vs V_{In} (TK63142B/H/S)

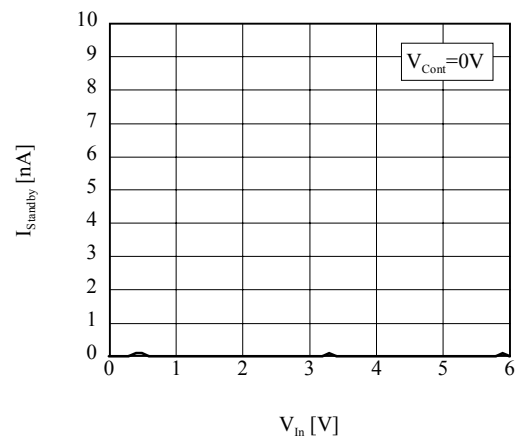

■ I_{GND} vs I_{Out} (TK63115B/H/S)

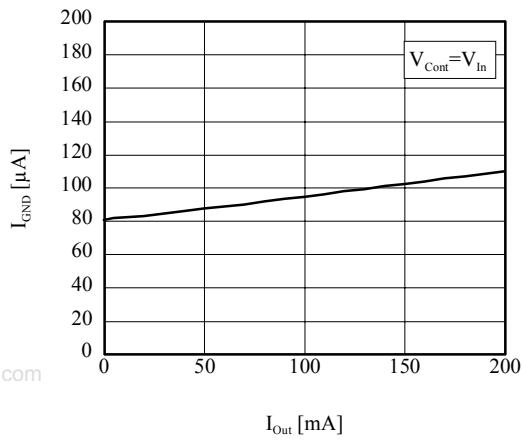

■ I_Q vs T_a (TK63115B/H/S)

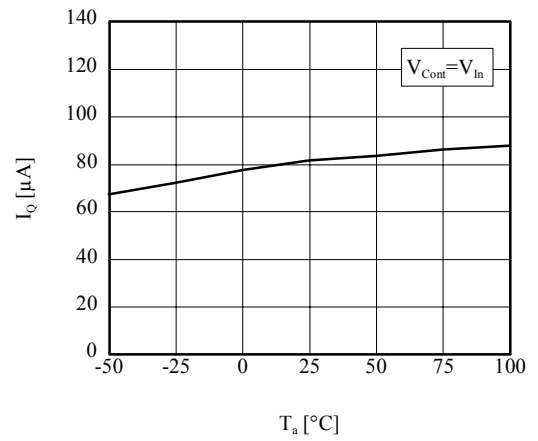

■ I_{GND} vs I_{Out} (TK63128B/H/S)

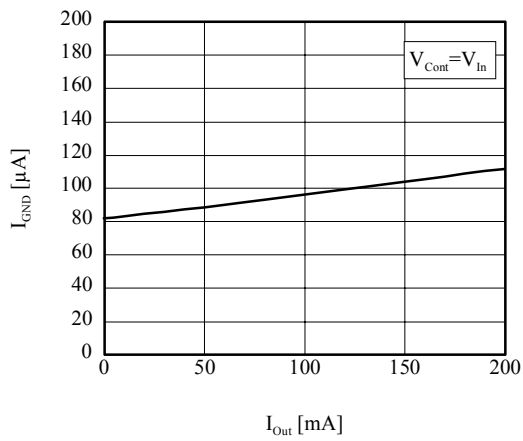

■ I_Q vs T_a (TK63128B/H/S)

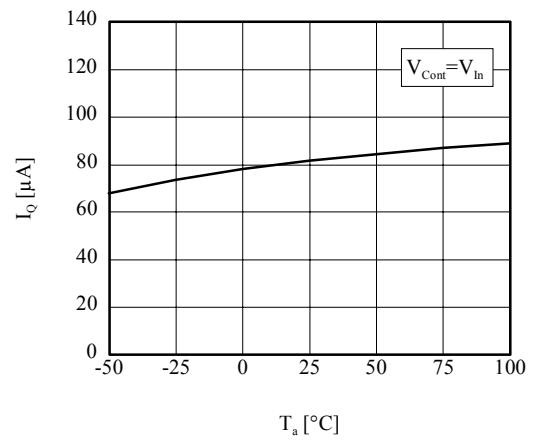

■ I_{GND} vs I_{Out} (TK63142B/H/S)

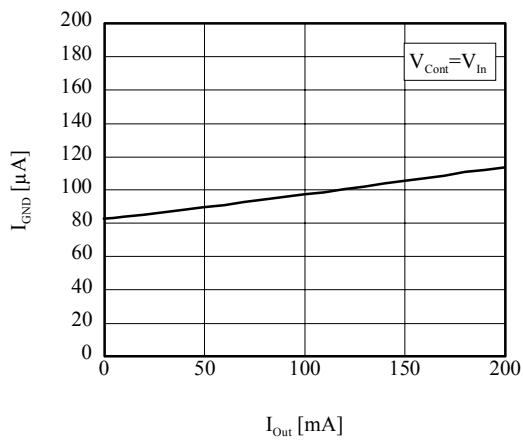

■ I_Q vs T_a (TK63142B/H/S)

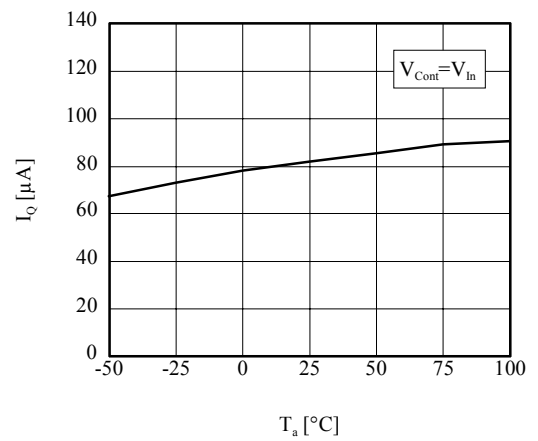

■ I_{GND} vs T_a (TK63115B/H/S)

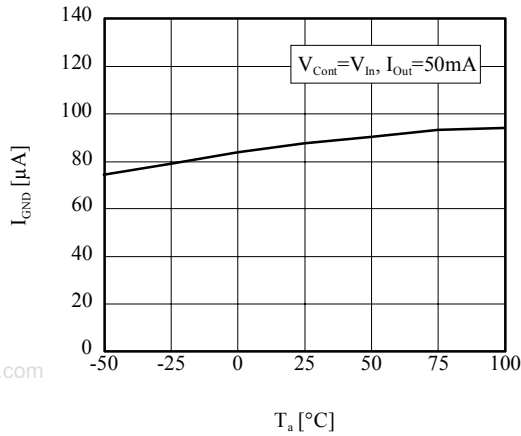

■ I_{Cont} vs V_{Cont} , V_{Out} vs V_{Cont} (TK63115B/H/S)

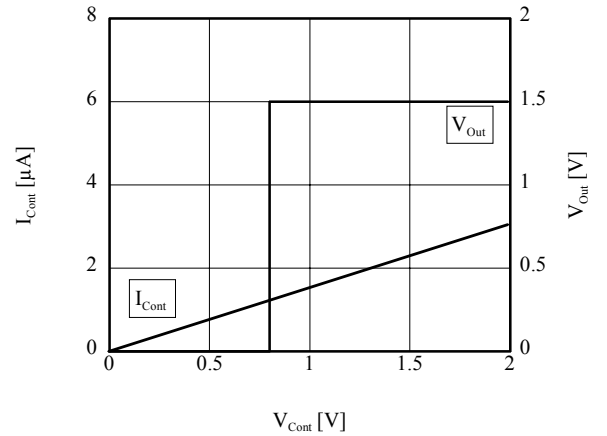

■ I_{GND} vs T_a (TK63128B/H/S)

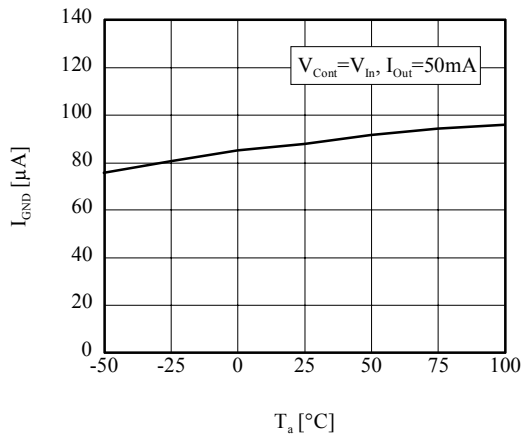

■ I_{Cont} vs V_{Cont} , V_{Out} vs V_{Cont} (TK63128B/H/S)

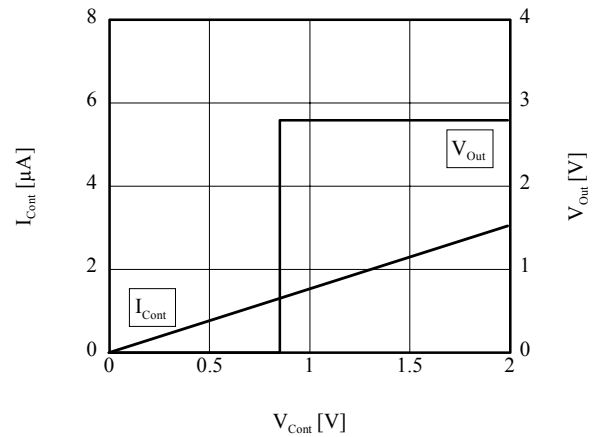

■ I_{GND} vs T_a (TK63142B/H/S)

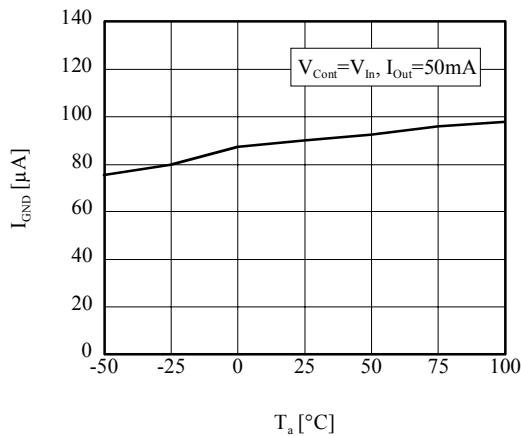

■ I_{Cont} vs V_{Cont} , V_{Out} vs V_{Cont} (TK63142B/H/S)

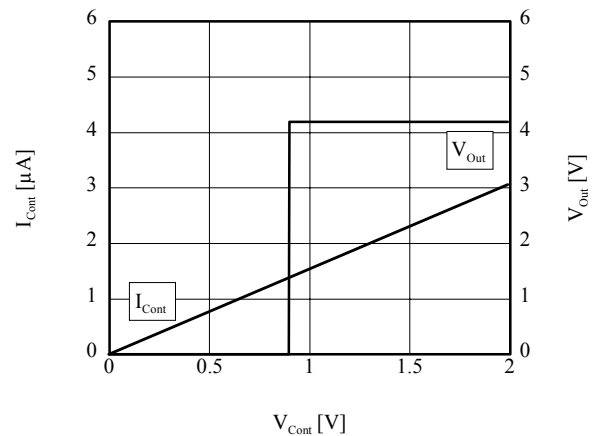

■ V_{Cont} vs T_a (TK63115B/H/S)

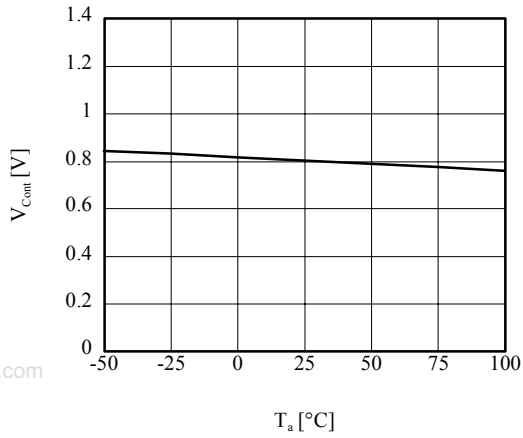

■ I_{Cont} vs T_a (TK631xxB/H/S)

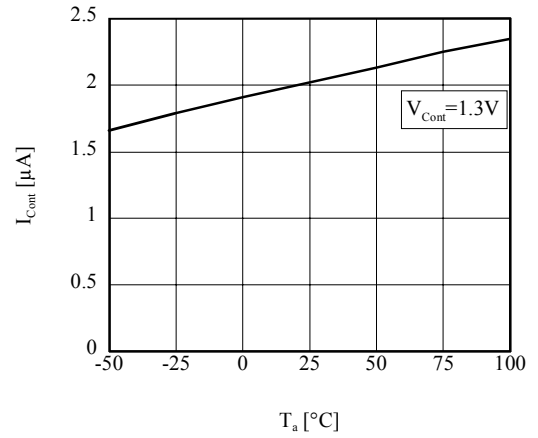

■ V_{Cont} vs T_a (TK63128B/H/S)

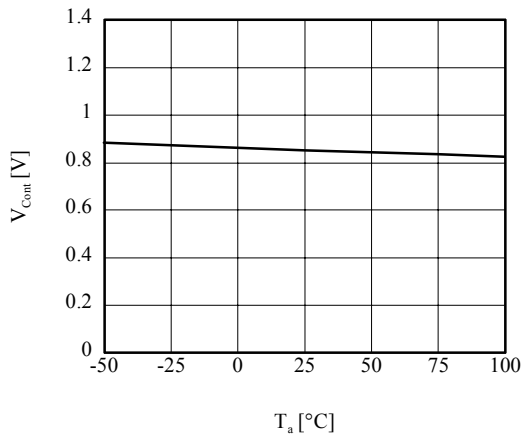

■ V_{Cont} vs T_a (TK63142B/H/S)

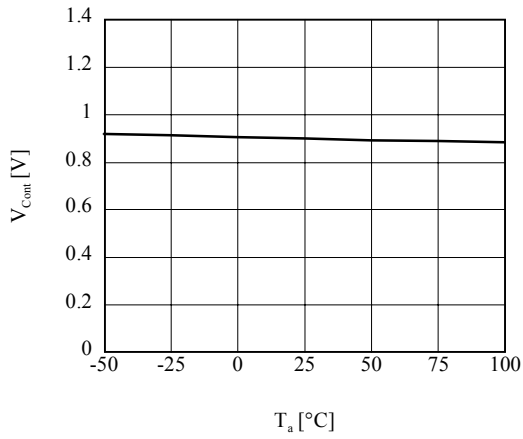

10-2. AC CHARACTERISTICS

■ RR vs V_{in} (TK63115B/H/S)

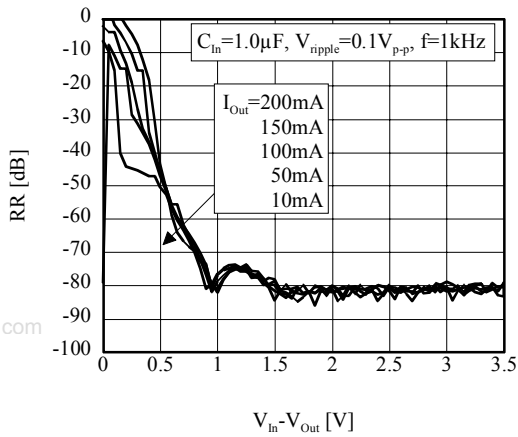

■ RR vs Frequency (TK63115B/H/S)

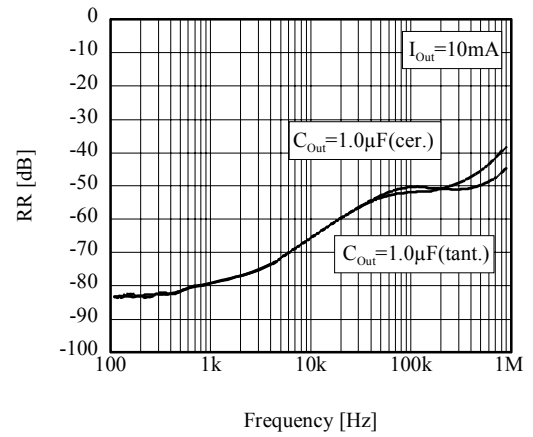

■ RR vs V_{in} (TK63128B/H/S)

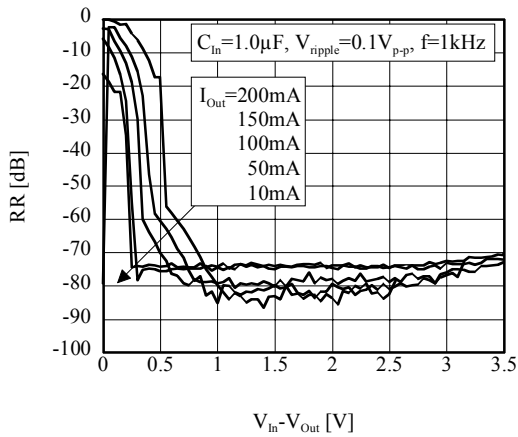

■ RR vs Frequency (TK63128B/H/S)

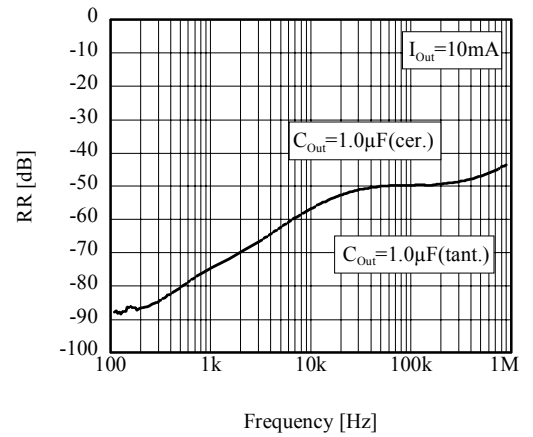

■ RR vs V_{in} (TK63142B/H/S)

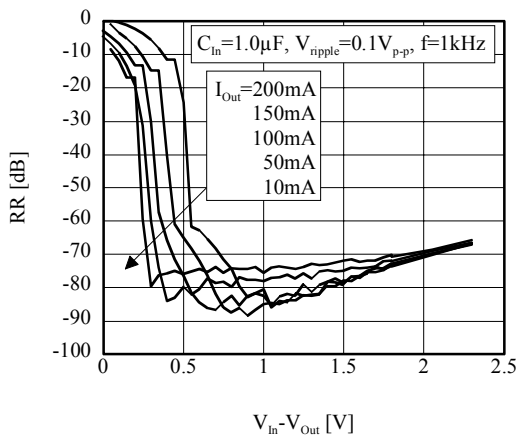

■ RR vs Frequency (TK63142B/H/S)

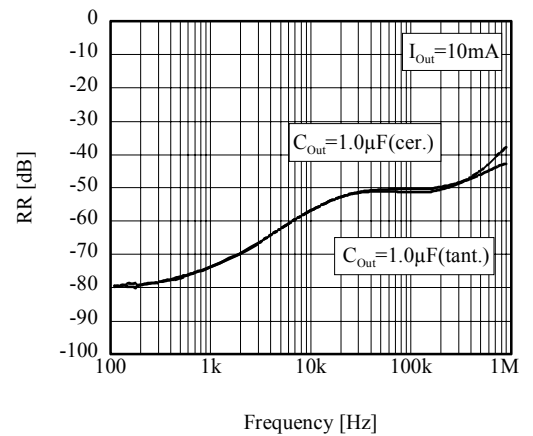

■ RR vs Frequency (TK63115B/H/S)

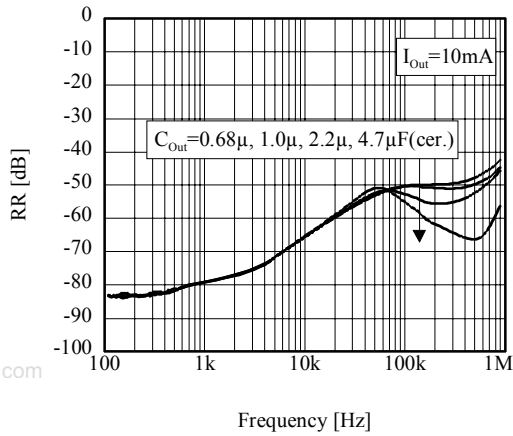

The ripple rejection (RR) characteristic depends on the characteristic and the capacitance value of the capacitor connected to the output side. The RR characteristic of 50kHz or more varies greatly with the capacitor on the output side and PCB pattern. If necessary, please confirm stability of your design.

■ RR vs Frequency (TK63128B/H/S)

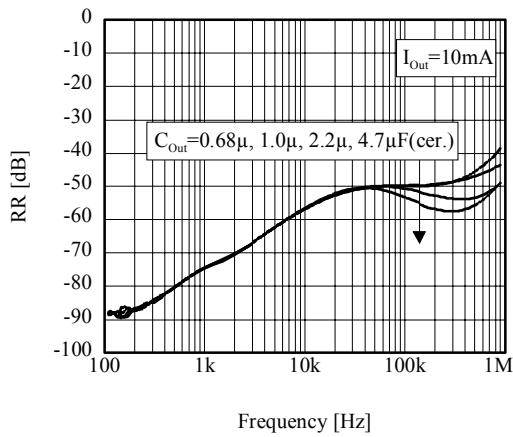

■ RR vs Frequency (TK63142B/H/S)

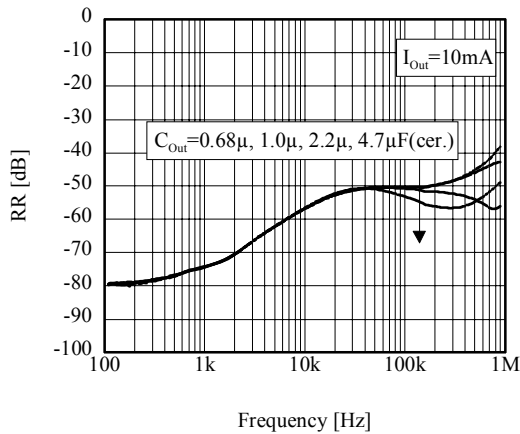

■ V_{Noise} vs V_{In} (TK63115B/H/S)

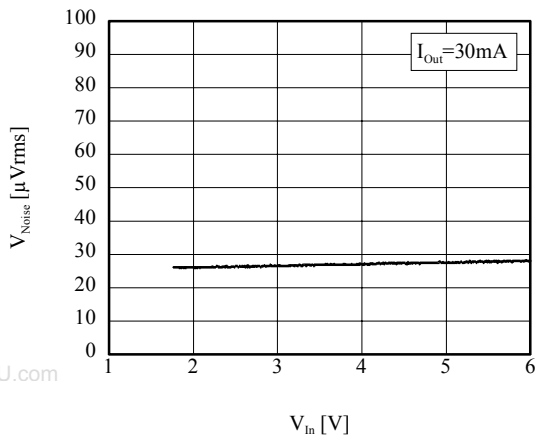

■ V_{Noise} vs I_{Out} (TK63115B/H/S)

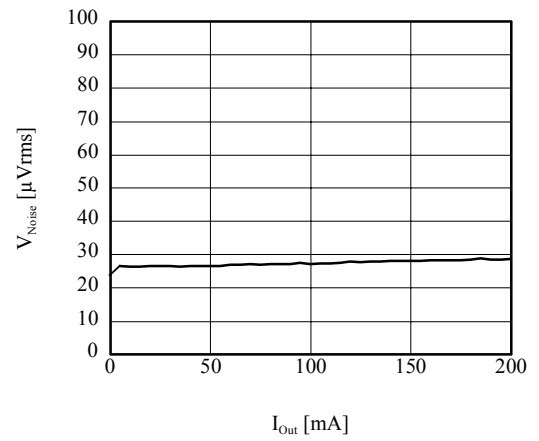

■ V_{Noise} vs V_{In} (TK63128B/H/S)

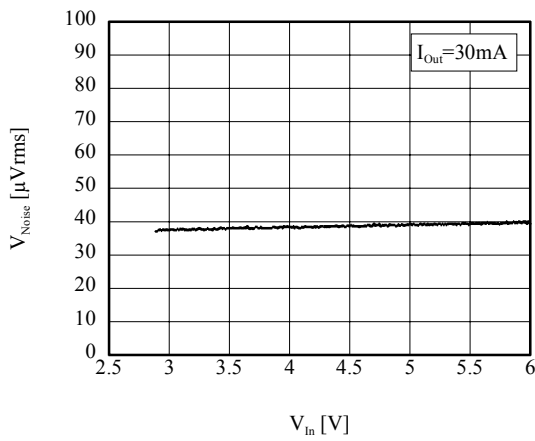

■ V_{Noise} vs I_{Out} (TK63128B/H/S)

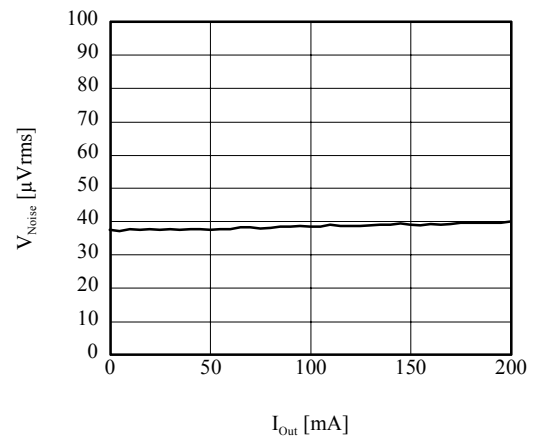

■ V_{Noise} vs V_{In} (TK63142B/H/S)

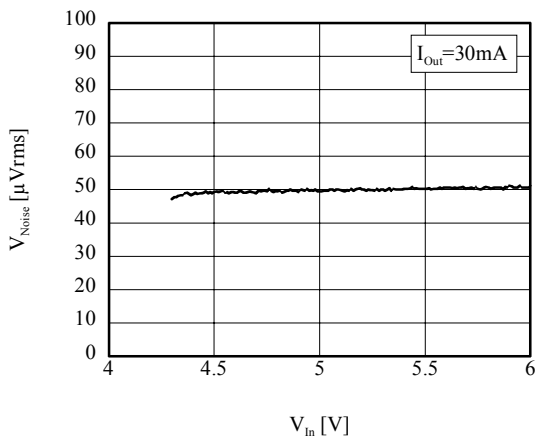

■ V_{Noise} vs I_{Out} (TK63142B/H/S)

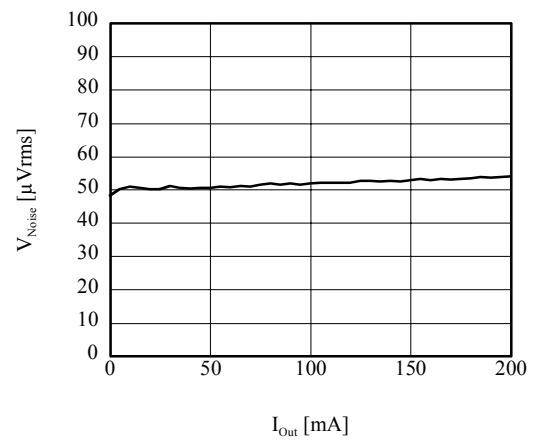

■ V_{Noise} vs V_{Out} (TK631xxB/H/S)

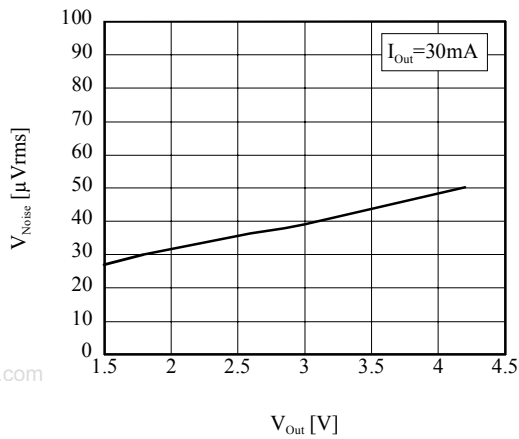

■ V_{Noise} vs Frequency (TK63115B/H/S)

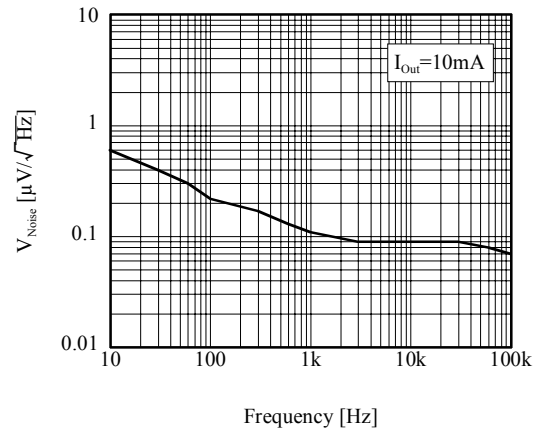

■ V_{Noise} vs Frequency (TK63128B/H/S)

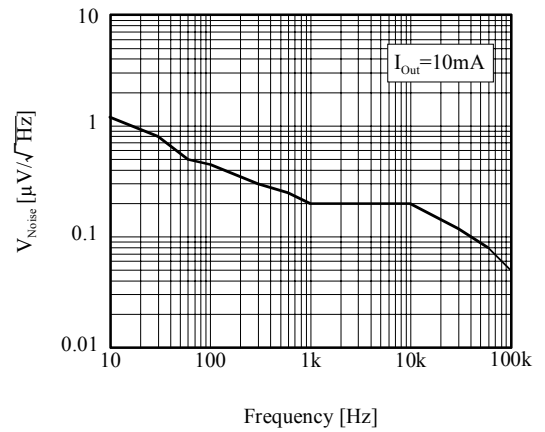

■ V_{Noise} vs Frequency (TK63142B/H/S)

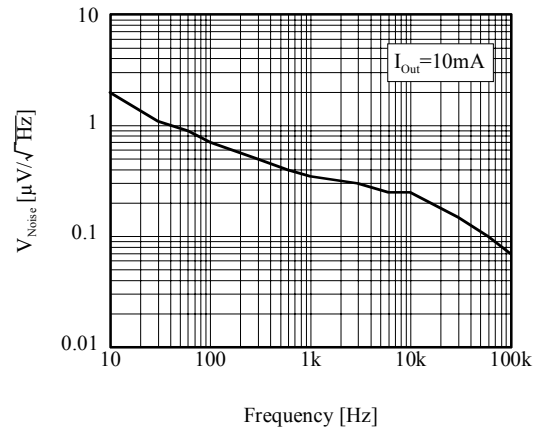

10-3. TRANSIENT CHARACTERISTICS

■ Line Transient (TK63115B/H/S)

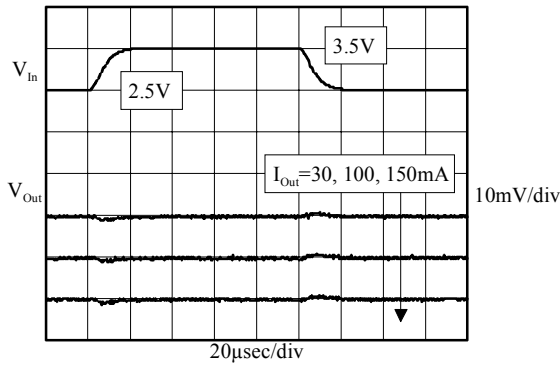

■ Load Transient ($I_{out} = 5 \leftrightarrow 100\text{mA}$) (TK63115B/H/S)

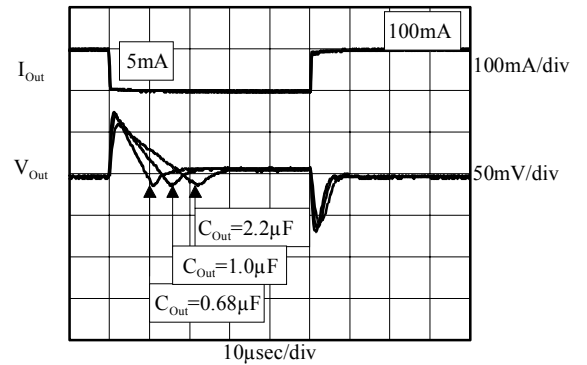

■ Line Transient (TK63128B/H/S)

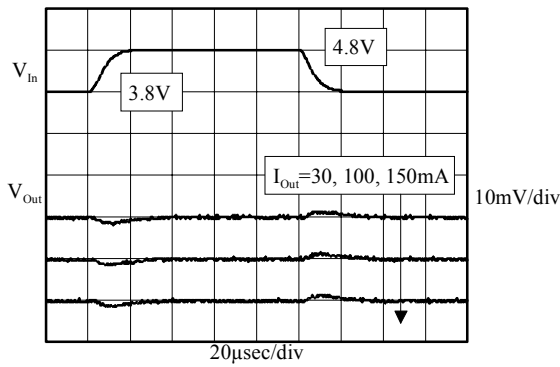

■ Load Transient ($I_{out} = 5 \leftrightarrow 100\text{mA}$) (TK63128B/H/S)

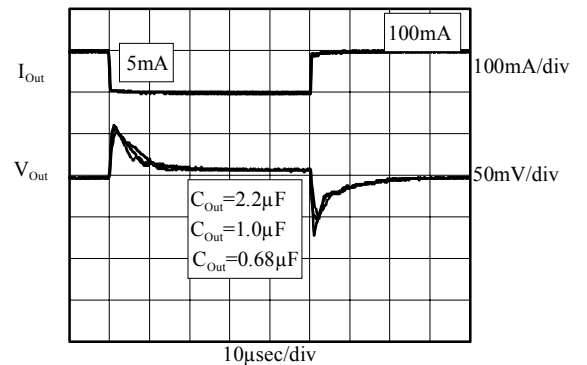

■ Line Transient (TK63142B/H/S)

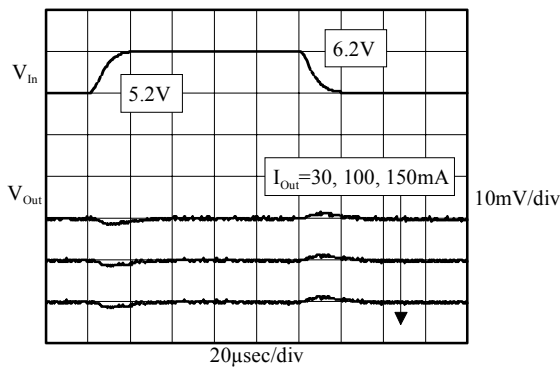

■ Load Transient ($I_{out} = 5 \leftrightarrow 100\text{mA}$) (TK63142B/H/S)

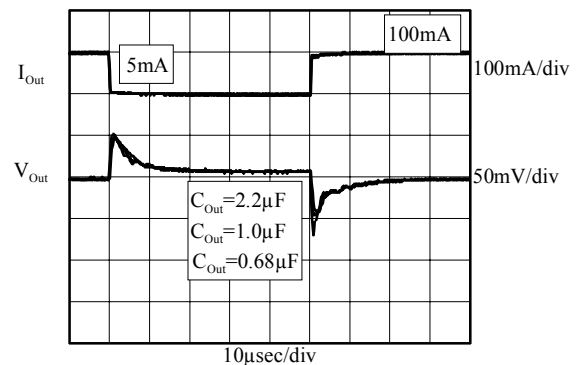

■ Load Transient ($I_{Out}=0 \leftrightarrow 100mA$) (TK63115B/H/S)

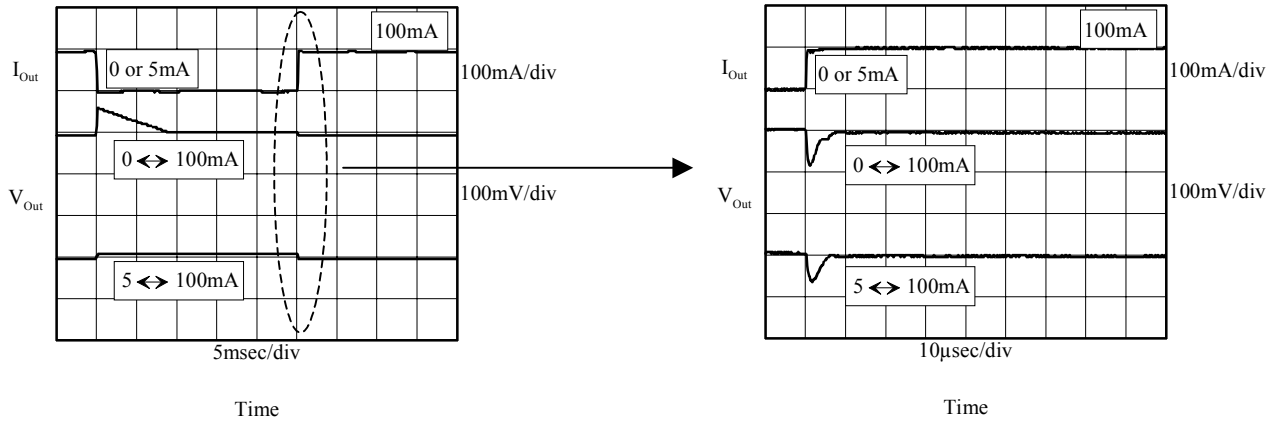

■ Load Transient ($I_{Out}=0 \leftrightarrow 100mA$) (TK63128B/H/S)

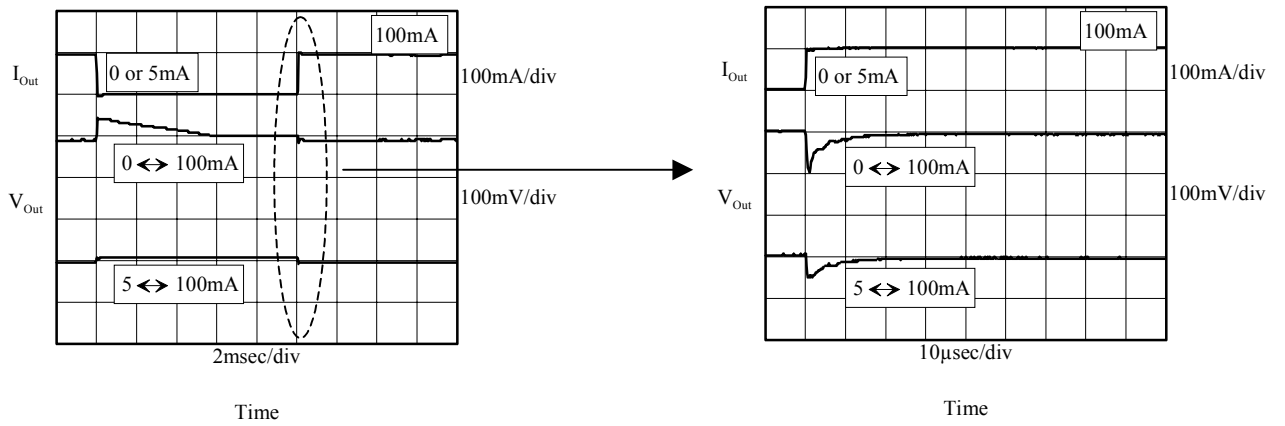

■ Load Transient ($I_{Out}=0 \leftrightarrow 100mA$) (TK63142B/H/S)

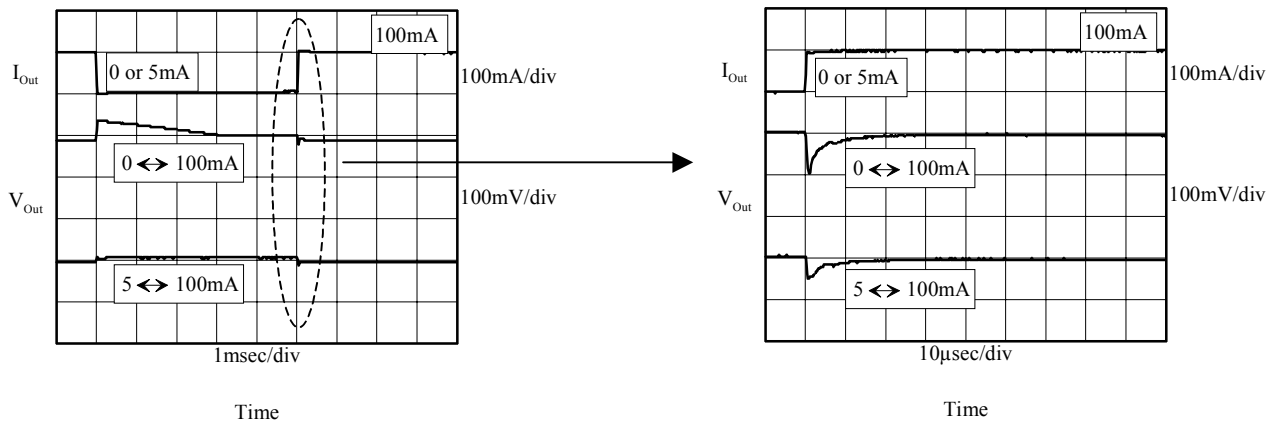

■ On/Off Transient ($V_{Cont}=0 \rightarrow 1.3V$) (TK63115B/H/S)

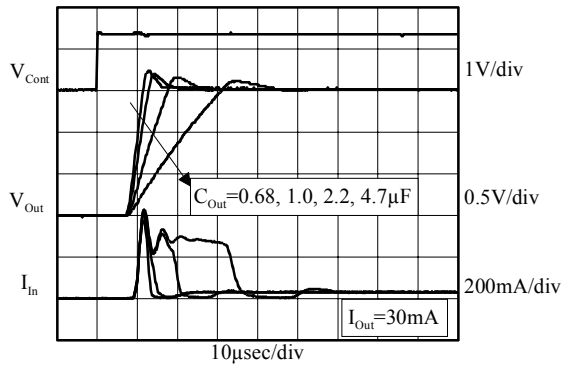

Time

■ On/Off Transient ($V_{Cont}=1.3 \rightarrow 0V$) (TK63115B/H/S)

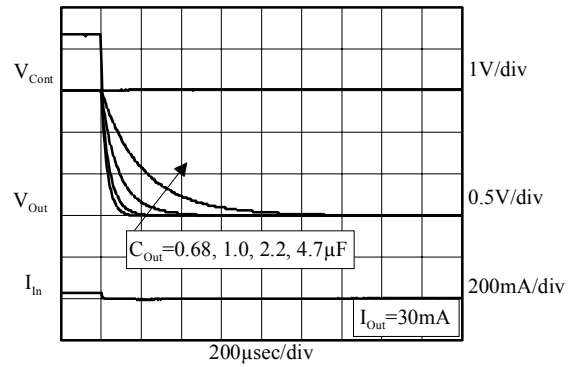

Time

■ On/Off Transient ($V_{Cont}=0 \rightarrow 1.3V$) (TK63128B/H/S)

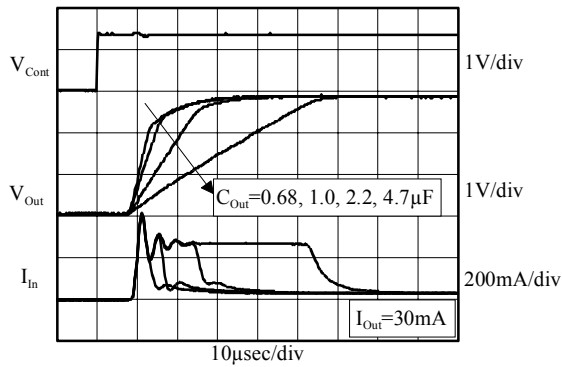

Time

■ On/Off Transient ($V_{Cont}=1.3 \rightarrow 0V$) (TK63128B/H/S)

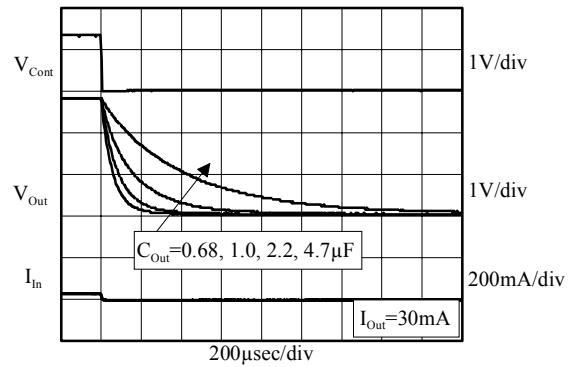

Time

■ On/Off Transient ($V_{Cont}=0 \rightarrow 1.3V$) (TK63142B/H/S)

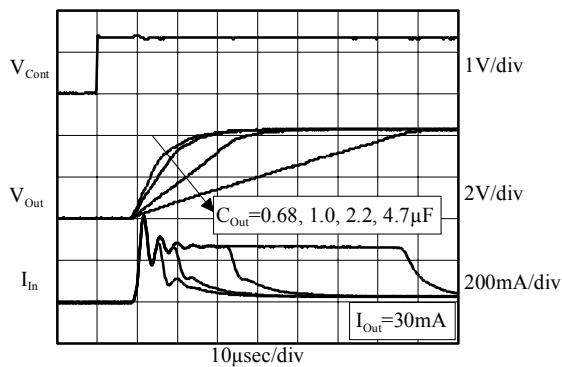

Time

■ On/Off Transient ($V_{Cont}=1.3 \rightarrow 0V$) (TK63142B/H/S)

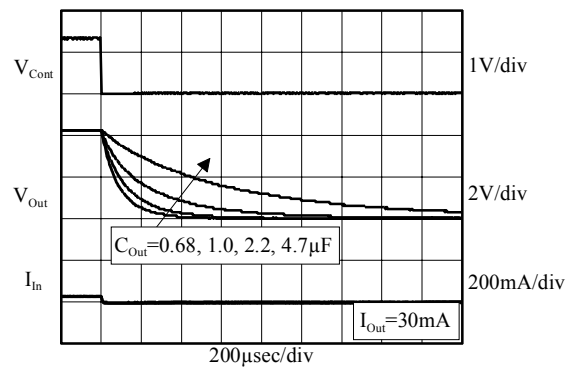

Time

11. PIN DESCRIPTION

Pin No.			Pin Description	Internal Equivalent Circuit	Description
TK631xxB	TK631xxH	TK631xxS			
A1	2, 5	2	GND		GND Terminal
A2	6	3	V _{Cont}		Control Terminal $V_{Cont} > 1.3V$: On $V_{Cont} < 0.25V$: Off The pull-down resistor (about 675kΩ) is built-in.
B1	3	5	V _{Out}		Output Terminal
B2	1	1	V _{In}		Input Terminal
	4	4	NC		No Connected

12. APPLICATIONS INFORMATION

12-1. Stability

Linear regulators require input and output capacitors in order to maintain the regulator's loop stability. If a 1.0μF capacitor is connected to the output side, the IC provides stable operation. However, it is recommended to use as large a value capacitor as is practical. The output noise and the ripple noise decrease as the value of the capacitor increases.

A recommended value of the application is as follows.

$$C_{In}=1.0\mu F, C_{Out}=1.0\mu F$$

It is not possible to determine this indiscriminately. Please confirm the stability in your design.

Fig12-1: Capacitor in the application

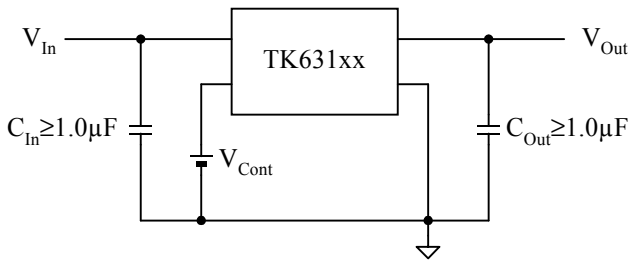

Fig12-2: Output Current vs Stable Operation Area (TK631xxB)

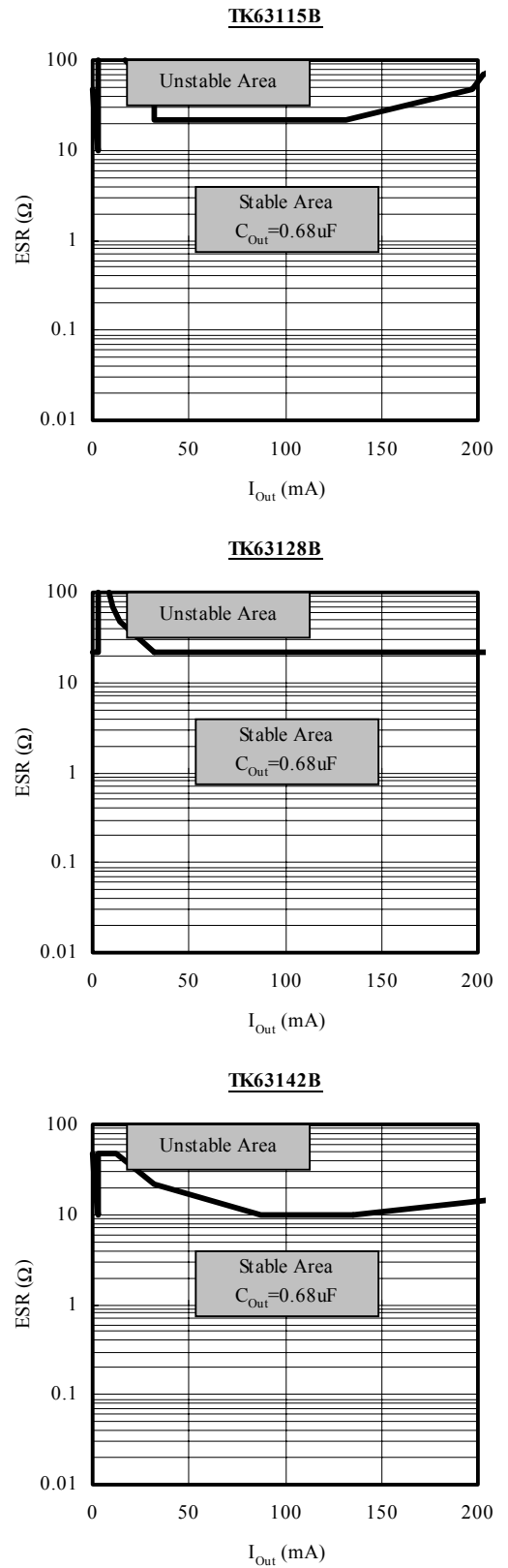

Fig12-3: Output Current vs Stable Operation Area (TK631xxH/S)

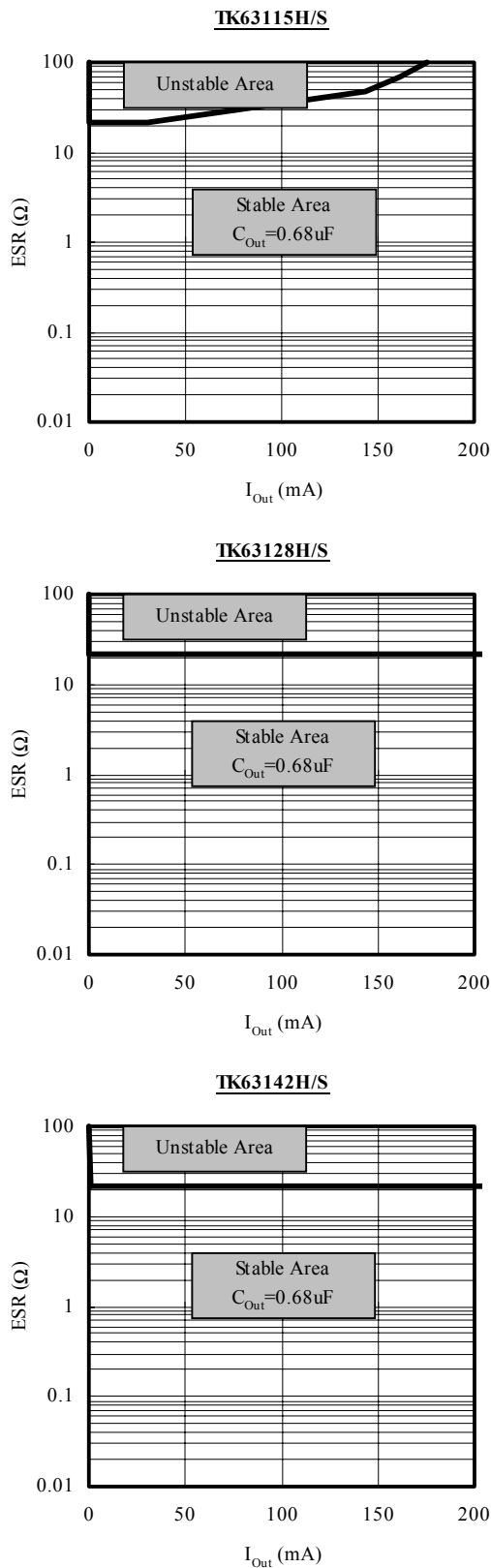
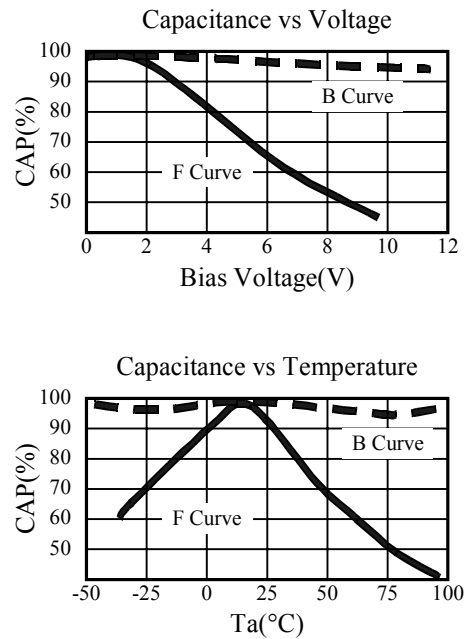

Fig.12-2 and Fig.12-3 show the stable operation area of output current and the equivalent series resistance (ESR) with a ceramic capacitor of 0.68μF. ESR of the output capacitor must be in the stable operation area. Please select the best output capacitor according to the voltage and current used. The stability of the regulator improves as the value of the output side capacitor increases (the stable operation area extends.) Please use as large a value capacitor as is practical.

For evaluation

- Kyocera : CM05B104K10AB , CM05B224K10AB , CM105B104K16A , CM105B224K16A , CM21B225K10A
- Murata : GRM36B104K10 , GRM42B104K10 , GRM39B104K25 , GRM39B224K10 , GRM39B105K6.3

Fig12-4: ex. Ceramic Capacitance vs Voltage, Temperature



Generally, a ceramic capacitor has both a temperature characteristic and a voltage characteristic. Please consider both characteristics when selecting the part. The B curves are the recommended characteristics.

12-2. Layout

Fig12-5: Layout example (TK631xxB)

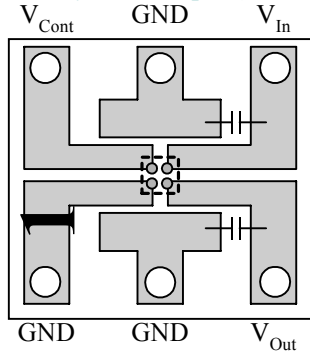

PCB Material : Glass epoxy
Size : 7mm×8mm×0.8mm

Fig12-6: Layout example (TK631xxH)

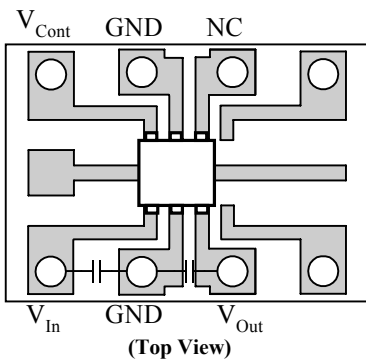

PCB Material : Glass epoxy
Size : 10mm×7mm×0.8mm

Fig12-7: Layout example (TK631xxS)

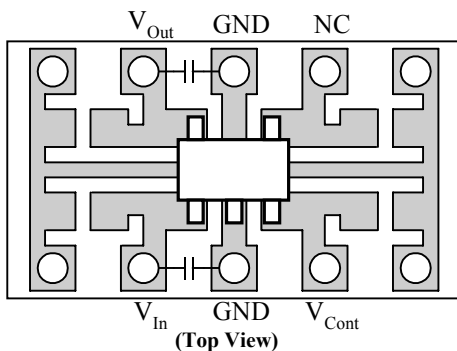

PCB Material : Glass epoxy
Size : 12mm×7mm×0.8mm

Please do derating with 2.9mW/°C at Pd=360mW(FC-4), or with 4mW/°C at Pd=500mW(SON2017-6/SOT23-5), and 25°C or more. Thermal resistance (θ_{ja}) is=250°C/W.

Fig12-8: Derating Curve (TK631xxB)

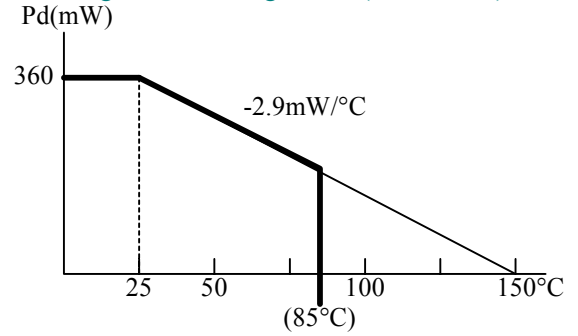
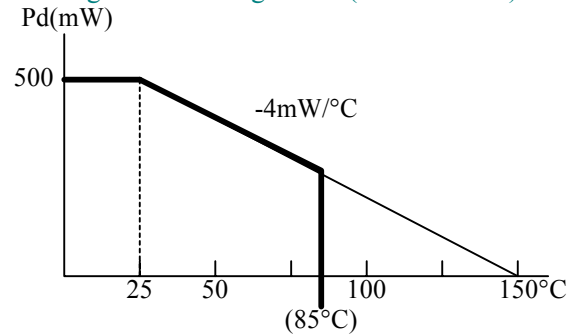

Fig12-9: Derating Curve (TK631xxH/S)



The package loss is limited at the temperature that the internal temperature sensor works (about 150°C). Therefore, the package loss is assumed to be an internal limitation. There is no heat radiation characteristic of the package unit assumed because of its small size. Heat is carried away from the device by being mounted on the PCB. This value is directly effected by the material and the copper pattern etc. of the PCB. The losses are approximately 360mW(FC-4), or 500mW(SON2017-6/SOT23-5). Enduring these losses becomes possible in a lot of applications operating at 25°C.

The overheating protection circuit operates when the junction temperature reaches 150°C (this happens when the regulator is dissipating excessive power, outside temperature is high, or heat radiation is bad). The output current and the output voltage will drop when the protection circuit operates. However, operation begins again as soon as the output voltage drops and the temperature of the chip decreases.

How to determine the thermal resistance when mounted on PCB

The thermal resistance when mounted is expressed as follows:

$$T_j = \theta_{ja} \times Pd + T_a$$

T_j of IC is set around 150°C. Pd is the value when the thermal sensor is activated.

If the ambient temperature is 25°C, then:

$$150 = \theta_{ja} \times Pd + 25$$

$$\theta_{ja} = 125 / Pd \text{ (}^\circ\text{C / mW)}$$

Pd is easily calculated.

A simple way to determine Pd is to calculate $V_{in} \times I_{in}$ when the output side is shorted. Input current gradually falls as output voltage rises after working thermal shutdown. You should use the value when thermal equilibrium is reached.

Fig12-10: How to determine DPd

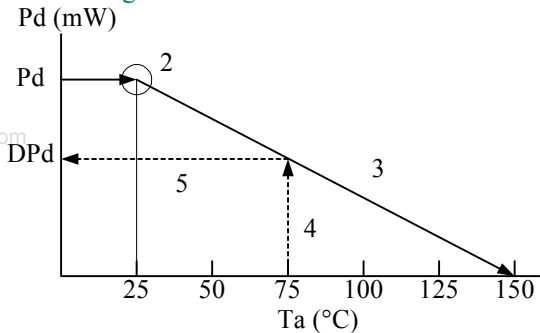

Procedure (When mounted on PCB.)

1. Find Pd ($V_{in} \times I_{in}$ when the output side is short-circuited).
2. Plot Pd against 25°C.
3. Connect Pd to the point corresponding to the 150°C with a straight line.
4. In design, take a vertical line from the maximum operating temperature (e.g., 75°C) to the derating curve.
5. Read off the value of Pd against the point at which the vertical line intersects the derating curve. This is taken as the maximum power dissipation DPd.
6. $DPd \div (V_{in,MAX} - V_{out}) = I_{out}$ (at 75°C)

The maximum output current at the highest operating temperature will be $I_{out} \cong DPd \div (V_{in,MAX} - V_{out})$. Please use the device at low temperature with better radiation. The lower temperature provides better quality.

12-3. On/Off Control

It is recommended to turn the regulator Off when the circuit following the regulator is not operating. A design with little electric power loss can be implemented. We recommend the use of the On/Off control of the regulator without using a high side switch to provide an output from the regulator. A highly accurate output voltage with low voltage drop is obtained.

Because the control current is small, it is possible to control it directly by CMOS logic.

Fig12-11: The use of On/Off control

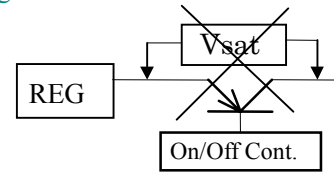

Control Terminal Voltage (V_{Cont})	On/Off State
$V_{Cont} > 1.3V$	On
$V_{Cont} < 0.25V$	Off

Parallel Connected On/Off Control

Fig12-12: The example of parallel connected IC

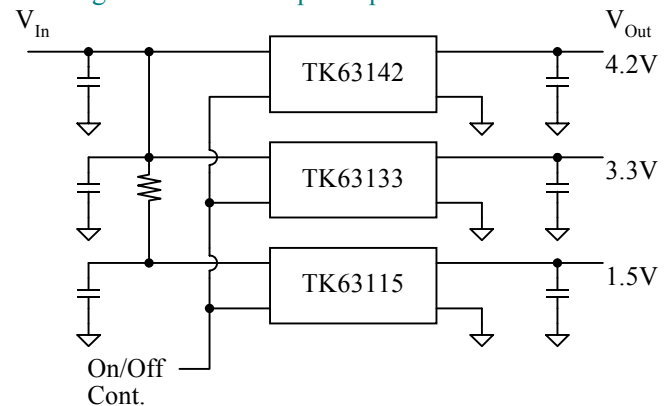

The above figure is multiple regulators being controlled by a single On/Off control signal. There is concern of overheating, because the power loss of the low voltage side IC (TK63115B/H/S) is large. The series resistor (R) is put in the input line of the low output voltage regulator in order to prevent over-dissipation. The voltage dropped across the resistor reduces the large input-to-output voltage across the regulator, reducing the power dissipation in the device. When the thermal sensor works, a decrease of the output voltage, oscillation, etc. may be observed.

12-4. Influence by Light(TK631xxB)

When TK631xxB (FC-4) is exposed to strong light, the electrical characteristics change. Please confirm the influence by light in your design.

12-5. Definition of term

Characteristics

◆ **Output Voltage (V_{Out})**

The output voltage is specified with $V_{In}=(V_{OutTYP}+1V)$ and $I_{Out}=5mA$.

◆ **Maximum Output Current ($I_{Out, MAX}$)**

The rated output current is specified under the condition where the output voltage drops to 90% of the value specified with $I_{Out}=5mA$. The input voltage is set to $V_{OutTYP}+1V$ and the current is pulsed to minimize temperature effect.

◆ **Dropout Voltage (V_{Drop})**

The dropout voltage is the difference between the input voltage and the output voltage at which point the regulator starts to fall out of regulation. Below this value, the output voltage will fall as the input voltage is reduced. It is dependent upon the output voltage, the load current, and the junction temperature.

◆ **Line Regulation (LinReg)**

Line regulation is the ability of the regulator to maintain a constant output voltage as the input voltage changes. The line regulation is specified as the input voltage is changed from $V_{In}=V_{Out,TYP}+1V$ to $V_{In}=6V$. It is a pulse measurement to minimize temperature effect.

◆ **Load Regulation (LoaReg)**

Load regulation is the ability of the regulator to maintain a constant output voltage as the load current changes. It is a pulsed measurement to minimize temperature effects with the input voltage set to $V_{In}=V_{Out,TYP}+1V$. The load regulation is specified under an output current step condition of 5mA to 100mA.

◆ **Ripple Rejection (RR)**

Ripple rejection is the ability of the regulator to attenuate the ripple content of the input voltage at the output. It is specified with 500mV_{p-p}, 1kHz super-imposed on the input voltage, where $V_{In}=V_{Out,TYP}+1.5V$. Ripple rejection is the ratio of the ripple content of the output vs. input and is expressed in dB.

◆ **Standby Current ($I_{Standby}$)**

Standby current is the current which flows into the regulator when the output is turned off by the control function ($V_{Cont}=0V$).

Protections

◆ **Over Current Sensor**

The over current sensor protects the device when there is excessive output current. It also protects the device if the output is accidentally connected to ground.

◆ **Thermal Sensor**

The thermal sensor protects the device in case the junction temperature exceeds the safe value ($T_j=150^{\circ}C$). This temperature rise can be caused by external heat, excessive power dissipation caused by large input to output voltage drops, or excessive output current. The regulator will shut off when the temperature exceeds the safe value. As the junction temperatures decrease, the regulator will begin to operate again. Under sustained fault conditions, the regulator output will oscillate as the device turns off then resets. Damage may occur to the device under extreme fault.

Please prevent the loss of the regulator when this protection operates, by reducing the input voltage or providing better heat efficiency.

◆ **ESD**

MM : 200pF 0Ω 150V or more

HBM : 100pF 1.5kΩ 2000V or more

www.DataSheet4U.com

13. PACKAGE OUTLINE

■ 4-bump flip chip : FC-4

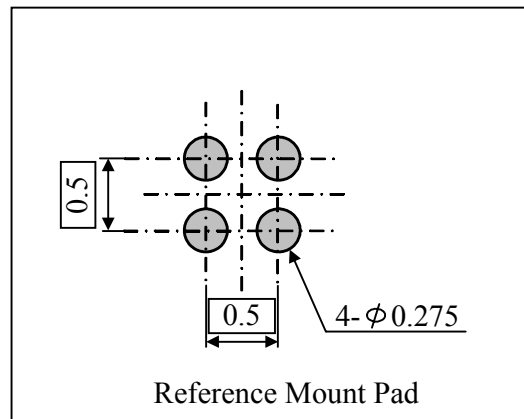
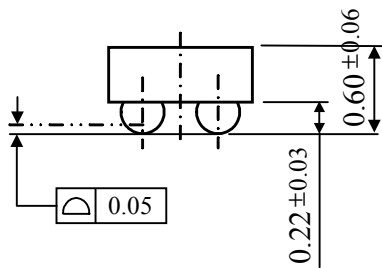
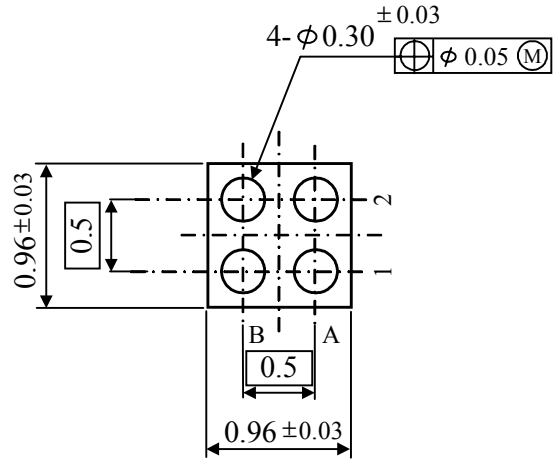
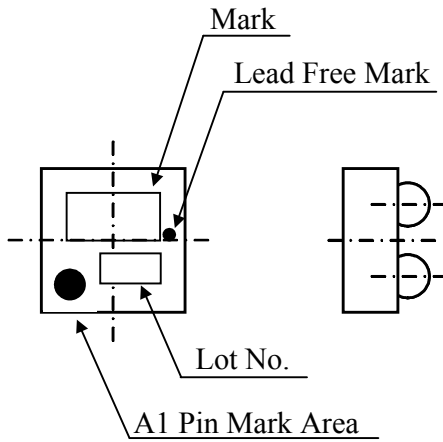

Unit : mm

Package Structure and Others

Base Material : Si
 Terminal Material : Lead Free Solder Bump
 Solder Composition : Sn-2.5Ag

Mark Method : Laser
 Country of Origin : Japan
 Mass : 0.0012g

Marking

Part Number	Marking Code	Part Number	Marking Code	Part Number	Marking Code
TK63115B	E15	TK63128B	E28	TK63133B	E33
TK63116B	E16	TK63101B	E01	TK63135B	E35
TK63118B	E18	TK63129B	E29		
TK63125B	E25	TK63130B	E30		
TK63126B	E26	TK63131B	E31		
TK63127B	E27	TK63132B	E32		

■ 6-Lead-Small Outline Non-Leaded Package : SON2017-6

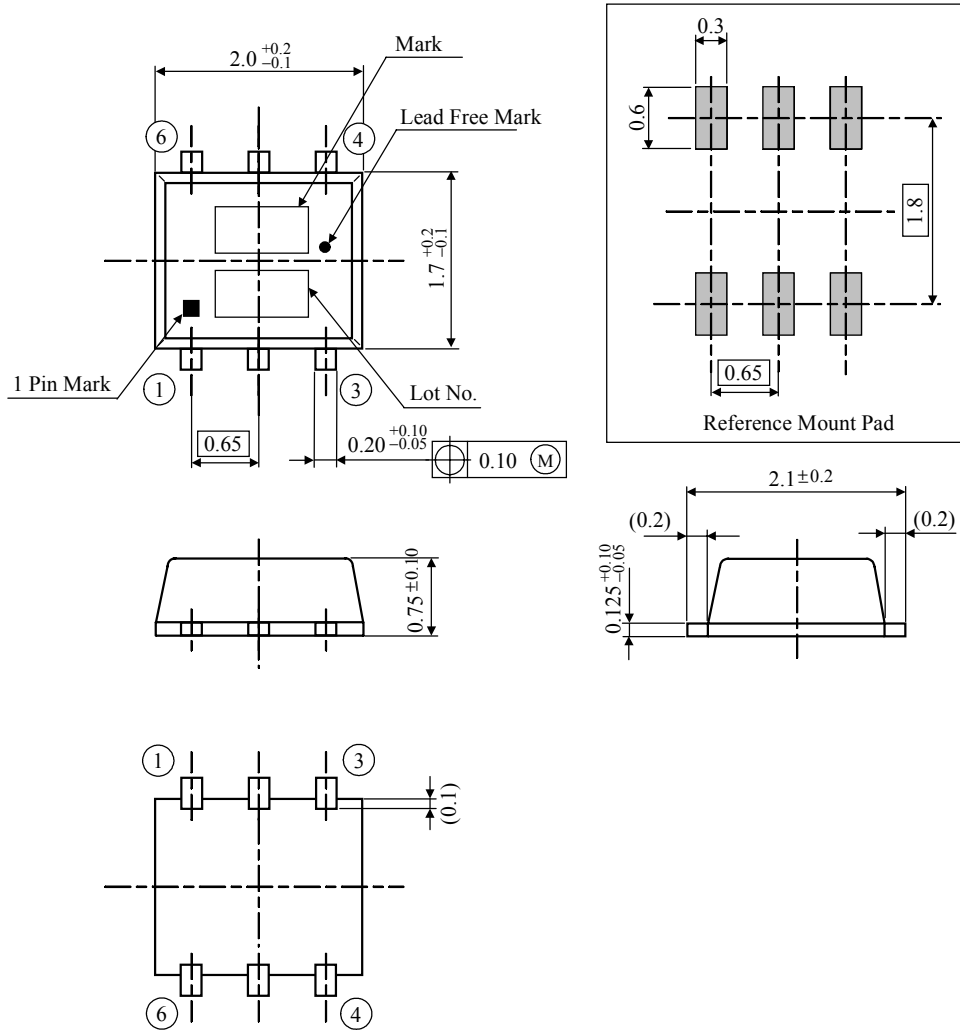

Unit : mm

Package Structure and Others

- | | | | |
|--------------------|------------------------------------|------------------|-----------|
| Package Material | : Epoxy Resin | Mark Method | : Laser |
| Terminal Material | : Copper Alloy | County of Origin | : Japan |
| Terminal Finish | : Lead Free Solder Plating(5~15µm) | Mass | : 0.0066g |
| Solder Composition | : Sn-2.5Ag | | |

Marking

Part Number	Marking Code	Part Number	Marking Code	Part Number	Marking Code
TK63115H	C15	TK63128H	C28	TK63133H	C33
TK63116H	C16	TK63101H	C01	TK63135H	C35
TK63118H	C18	TK63129H	C29		
TK63125H	C25	TK63130H	C30		
TK63126H	C26	TK63131H	C31		
TK63127H	C27	TK63132H	C32		

■ 5-Lead-Surface Mount Discrete Package: SOT23-5

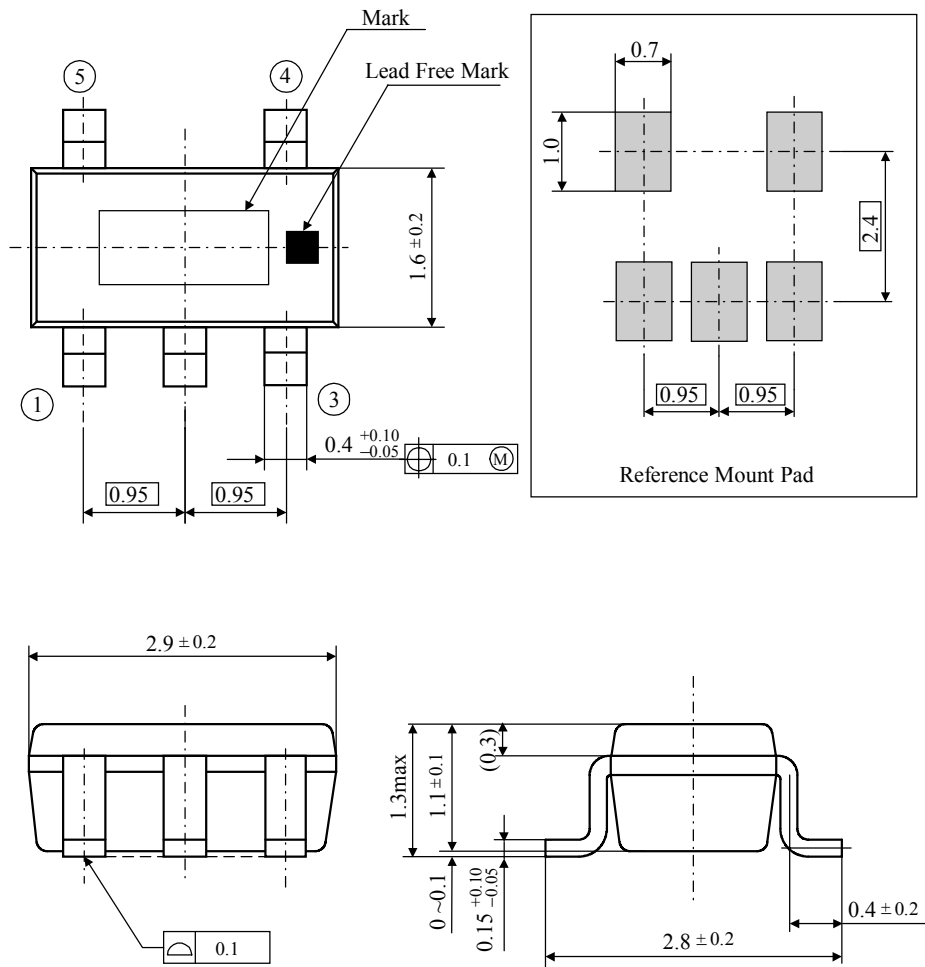

Unit : mm

Package Structure and Others

Package Material	: Epoxy Resin	Mark Method	: Laser
Terminal Material	: Copper Alloy	Country of Origin	: Japan
Terminal Finish	: Lead Free Solder Plating(5~15 μ m)	Mass	: 0.016g
Solder Composition	: Sn-2.5Ag		

Marking

Part Number	Marking Code	Part Number	Marking Code	Part Number	Marking Code
TK63115S	15J	TK63128S	28J	TK63133S	33J
TK63116S	16J	TK63101S	01J	TK63135S	35J
TK63118S	18J	TK63129S	29J		
TK63125S	25J	TK63130S	30J		
TK63126S	26J	TK63131S	31J		
TK63127S	27J	TK63132S	32J		

14. NOTES

■ Please be sure that you carefully discuss your planned purchase with our office if you intend to use the products in this application manual under conditions where particularly extreme standards of reliability are required, or if you intend to use products for applications other than those listed in this application manual.

● Power drive products for automobile, ship or aircraft transport systems; steering and navigation systems, emergency signal communications systems, and any system other than those mentioned above which include electronic sensors, measuring, or display devices, and which could cause major damage to life, limb or property if misused or failure to function.

● Medical devices for measuring blood pressure, pulse, etc., treatment units such as coronary pacemakers and heat treatment units, and devices such as artificial organs and artificial limb systems which augment physiological functions.

● Electrical instruments, equipment or systems used in disaster or crime prevention.

■ Semiconductors, by nature, may fail or malfunction in spite of our devotion to improve product quality and reliability. We urge you to take every possible precaution against physical injuries, fire or other damages which may cause failure of our semiconductor products by taking appropriate measures, including a reasonable safety margin, malfunction preventive practices and fire-proofing when designing your products.

■ This application manual is effective from Mar. 2006. Note that the contents are subject to change or discontinuation without notice. When placing orders, please confirm specifications and delivery condition in writing.

■ TOKO is not responsible for any problems nor for any infringement of third party patents or any other intellectual property rights that may arise from the use or method of use of the products listed in this application manual. Moreover, this application manual does not signify that TOKO agrees implicitly or explicitly to license any patent rights or other intellectual property rights which it holds.

■ None of the ozone depleting substances(ODS) under the Montreal Protocol are used in our manufacturing process.

15. OFFICES

If you need more information on this product and other TOKO products, please contact us.

■ TOKO Inc. Headquarters
1-17, Higashi-yukigaya 2-chome, Ohta-ku, Tokyo,
145-8585, Japan
TEL: +81.3.3727.1161
FAX: +81.3.3727.1176 or +81.3.3727.1169
Web site: <http://www.toko.co.jp/>

■ TOKO America
Web site: <http://www.toko.com/>

■ TOKO Europe
Web site: <http://www.tokoeurope.com/>

■ TOKO Hong Kong
Web site: <http://www.toko.com.hk/>

■ TOKO Taiwan
Web site: <http://www.tokohc.com.tw/>

■ TOKO Singapore
Web site: <http://www.toko.com.sg/>

■ TOKO Seoul
Web site: <http://www.toko.co.kr/>

■ TOKO Manila
Web site: <http://www.toko.com.ph/>

■ TOKO Brazil
Web site: <http://www.toko.com.br/>

**Semiconductor Division**

YOUR DISTRIBUTOR