

CDBA320L-HF Thru. CDBA340L-HF

Reverse Voltage: 20 to 40 Volts

Forward Current: 3.0 Amp

RoHS Device

Halogen free

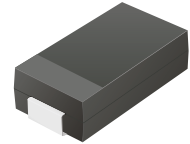

Features

- Low Profile surface mount applications in order to optimize board space.
- Low power loss, high efficiency.
- High current capability, low forward voltage drop.
- High surge capability.
- Guarding for overvoltage protection.
- Ultra high-speed switching.
- Silicon epitaxial planar chip, metal silicon junction.

Mechanical data

- Case: JEDEC DO-214AC / SMA, molded plastic.
- Epoxy: UL 94V-0 rate flame retardant.
- Terminals: Solder plated, Solderable per MIL-STD-750, method 2026.
- Polarity: Indicated by cathode band.
- Mounting position: Any.
- Weight: 0.055 grams

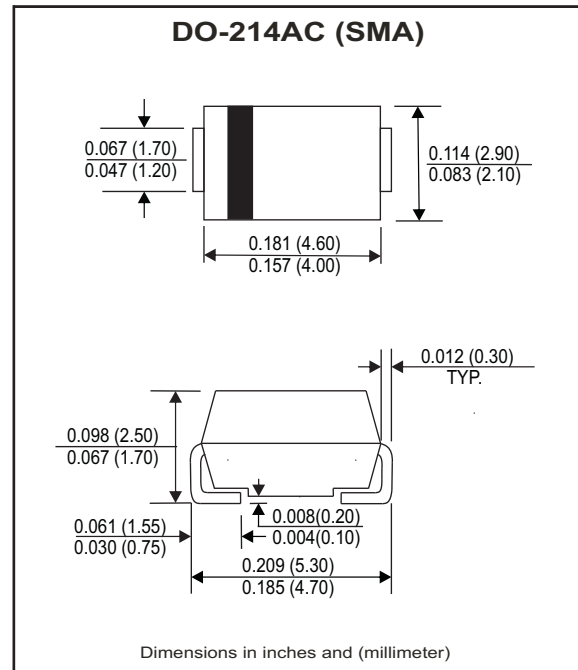

Maximum Ratings and Electrical Characteristics

Ratings at Ta=25°C unless otherwise noted.
 Single phase, half wave, 60Hz, resistive or inductive loaded.
 For capacitive load, derate current by 20% .

Parameter	Symbol	CDBA320L-HF	CDBA330L-HF	CDBA340L-HF	Unit
Max. Recurrent Peak Reverse Voltage	V _{RRM}	20	30	40	V
Max. RMS Voltage	V _{RMS}	14	21	28	V
Max. DC Blocking Voltage	V _{DC}	20	30	40	V
Max. Instantaneous Forward Voltage @3.0A, T _A =25°C	V _F	0.38	0.40		V
Max. Forward Rectified Current (See Fig.1)	I _O	3.0			A
Max. Forward Surge Current, 8.3ms single half sine-wave superimposed on rated load (JEDEC method)	I _{FSM}	80			A
Max. Reverse Current	V _R =V _{RRM} T _J =25°C	1.0			mA
	V _R =V _{RRM} T _J =100°C	20			
Typical Thermal Resistance (Note 1)	R _{θJA}	50			°C/W
Typical Diode Junction Capacitance(Note 2)	C _J	300			pF
Operating Temperature Range	T _J	-50 to +100			°C
Storage Temperature Range	T _{STG}	-50 to +150			°C

NOTES:
 1. Thermal resistance from junction to ambient.
 2. F=1MHz and applied 4V DC reverse Voltage.

RATING AND CHARACTERISTIC CURVES (CDBA320L-HF thru CDBA340L-HF)

Fig.1 - Typical Forward Current Derating Curve

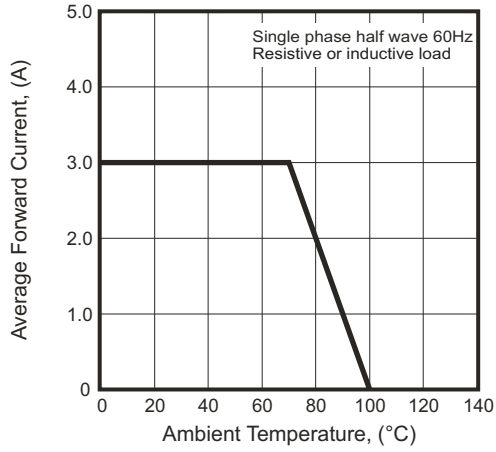

Fig.2 - Typical Forward Characteristics

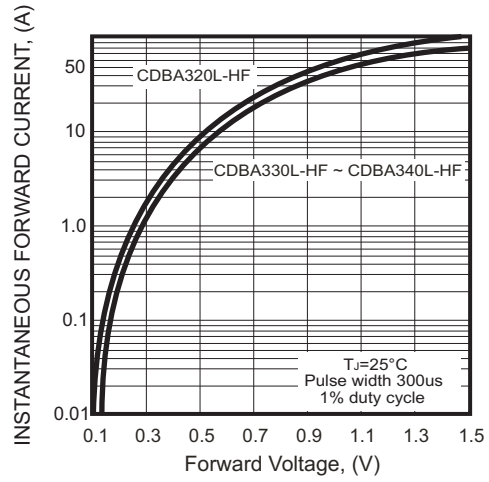

Fig.3 - Maximum Non-repetitive Forward Surge Current

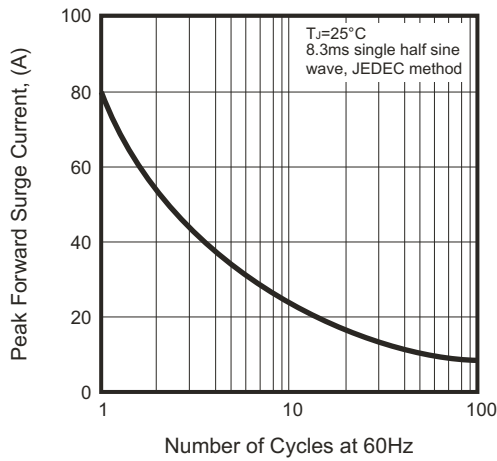

Fig.4 - Typical Junction Capacitance

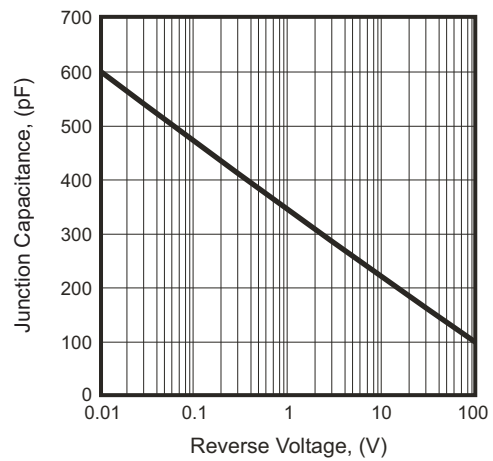
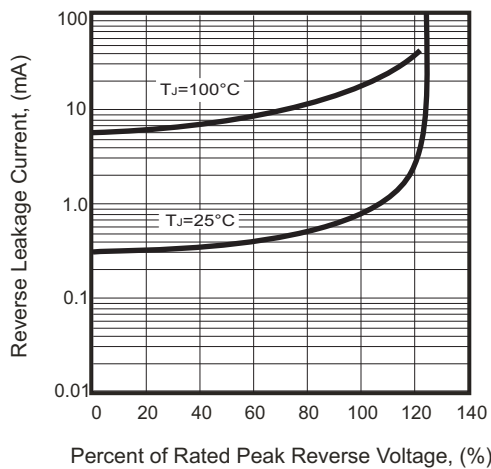
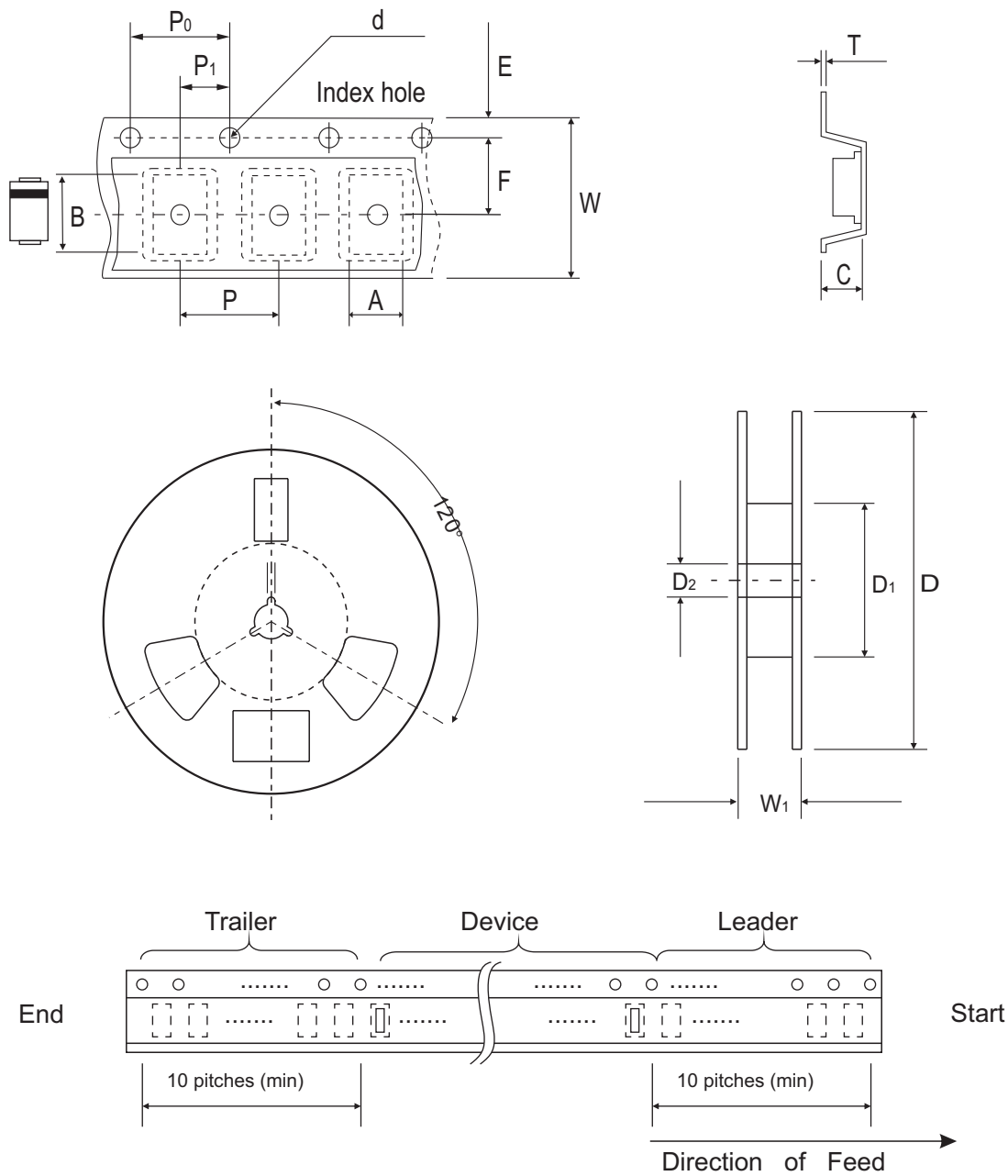

Fig.5 - Typical Reverse Characteristics



Reel Taping Specification



DO-214AC (SMA)	SYMBOL	A	B	C	d	D	D1	D2
	(mm)	2.70 ± 0.10	5.30 ± 0.10	2.66 ± 0.10	1.50 ± 0.10	330 ± 2.00	62.0 MIN.	13.50 ± 0.50
	(inch)	0.106 ± 0.004	0.209 ± 0.004	0.105 ± 0.004	0.059 ± 0.004	12.99 ± 0.079	2.441 MIN.	0.531 ± 0.020

DO-214AC (SMA)	SYMBOL	E	F	P	P0	P1	T	W	W1
	(mm)	1.75 ± 0.10	5.50 ± 0.10	4.00 ± 0.10	4.00 ± 0.10	2.00 ± 0.10	0.60 ± 0.10	12.0 ± 0.30	18.40 ± 1.00
	(inch)	0.069 ± 0.004	0.217 ± 0.004	0.157 ± 0.004	0.157 ± 0.004	0.079 ± 0.004	0.236 ± 0.004	0.472 ± 0.012	0.724 ± 0.039

Marking Code

Part Number	Marking Code
CDBA320L-HF	SL32
CDBA330L-HF	SL33
CDBA340L-HF	SL34

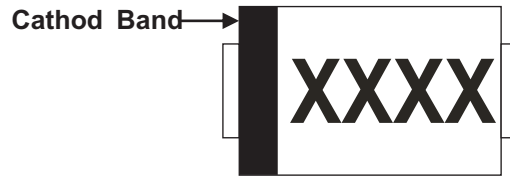

XXXX = Product type marking code

Suggested PAD Layout

SIZE	DO-214AC (SMA)	
	(mm)	(inch)
A	4.00	0.157
B	2.50	0.100
C	1.70	0.068
D	6.50	0.256
E	1.50	0.060

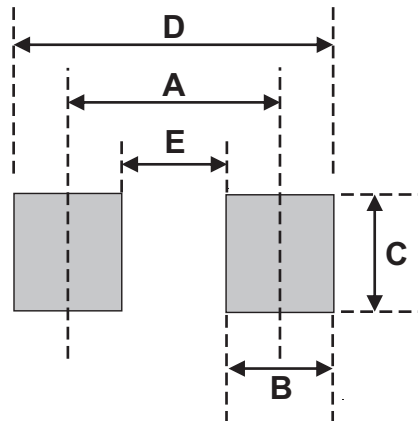

Standard Packaging

Case Type	REEL PACK	
	REEL (pcs)	Reel Size (inch)
DO-214AC (SMA)	5,000	13