

RTBV Series

1-2 Pole Coded Rotary Switches



Features/Benefits

- **Totally sealed**
- **Detent angles, 15 , 22.5 , 30 and 36**
- **Multi pole**
- **Coding functions**
- **Robust construction**

Typical Applications

- **Telecommunications**
- **Military**
- **Instrumentation**
- **Heavy-duty industrial equipment**

Electrical Data

SWITCHING MODE:
 MAX. SWITCHING POWER:
 MAX. SWITCHING CURRENT:
 MIN. SWITCHING CURRENT:
 MAX. CARRYING CURRENT:
 MAX. VOLTAGE:
 MIN. VOLTAGE:
 BOUNCE:
 CONTACT RESISTANCE after life:
 DIALECTRIC STRENGTH between contacts or contacts and frame:
 INSULATION RESISTANCE between contacts or contacts and frame:

Silver

BBM*
 5VA
 250 mA
 10 mA
 5A
 25V
 5V
 <5ms
 <100mΩ
 500 V rms
 >10⁹Ω

Gold

BBM*
 0.2VA
 20 mA
 1 mA
 1A
 25V
 1V
 <5ms
 <100mΩ
 500 V rms
 >10⁹Ω

Environmental Data

OPERATING TEMPERATURE: -25⁰C to +70⁰C
 STORAGE TEMPERATURE: -40⁰C to +85⁰C
 TOTALLY SEALED: Immersion test acc. to MIL R22.097 F and NFC 20631/QF

* BBM= Break Before Make (non-starting)

Materials

HOUSING: PBT thermoplastic and PC thermoplastic
 STATIONARY CONTACTS & TERMINALS: Nickel plated Brass with additional Gold or Silver plating, insert molded in PBT thermoplastic.
 ROTOR: Printed circuit, gold or silver plated.
 ACTUATOR: Steel
 BUSHING: Brass
 HARDWARE: Stop pin and spring: Stainless steel
 All models are RoHS compliant and compatible.

Mechanical Data

NUMBER OF BANKS: 1 to 10
 OPERATING TORQUE: 5 Ncm±30% (with 1 module)
 MECHANICAL STOP RESISTANCE: >70 Ncm
 BUSHING MOUNTING TORQUE: 100 Ncm

NOTE: Specifications and materials listed above are for switches with standard options. For information on specific and custom switches, consult Customer Service Center.

Build-A-Switch

To order, simply select desired option from each category and place in the appropriate box. Available options are shown and described on pages K-25 thru K-29. For additional options not shown in catalog, consult Customer Service Center.



Designation
RTBV

Indexing
1 15°/24 positions max.
2 22.5°/16 positions max.
3 30°/12 positions max.
4 36°/10 positions max.

Number of Banks**
1 1 Bank
2 2 Banks
3 3 Banks
4 4 Banks

Switch Function Number of Poles or code (binary code = B, complement = C, direct +complement = BC) (first digit), Stop (with=S, without=W), Maximum Position (third & fourth digit)

1S02 SP, 02 positions with stop
1S03 SP, 03 positions with stop
1S04 SP, 04 positions with stop
1S05 SP, 05 positions with stop
1S06 SP, 06 positions with stop
1S07 SP, 07 positions with stop
1S10 SP, 10 positions with stop
1W10 SP, 10 positions without stop
1S11 SP, 11 positions with stop
1S12 SP, 12 positions with stop
1W12 SP, 12 positions without stop

1S14 SP, 14 positions with stop
1S16 SP, 16 positions with stop
1W16 SP, 16 positions without stop
1S24 SP, 24 positions with stop
1W24 SP, 24 positions without stop
2S04 DP, 4 positions with stop
2S05 DP, 5 positions with stop
2S06 DP, 6 positions with stop

Seal

A Standard bushing for panel mount
D Sealed bushing for panel mount

Shaft Diameter & Style***

N Metric shaft .236 (6,0)
P Standard shaft .250 (6,35)
F Metric shaft with flat .236 (6,0)
G Standard shaft with flat .250 (6,35)
S Metric shaft with slot .236 (6,0)
T Standard shaft with slot .250 (6,35)

Actuator Option Angle*

N None for actuators without a flat
0 0° angle
3 30° angle
6 60° angle
9 90° angle
2 120° angle
8 180° angle
7 270° angle

Contact Material

S Silver plated, matte-tin terminal
P Gold plated, matte-tin terminal

Actuator Length

Z (.984) 25 mm

* Other angles available by request

** Several functions can be combined. For more information consult us.

***Note: Metric diameter shafts are only available with metric diameter bushings, standard 1.250 inch diameter shafts are only available with standard 3/8 diameter bushings.

NOTE: S&T Shaft Diameter and Style are only available with Actuator Option angle 0, 6, 9, 2.



Dimensions are shown: Inch (mm)
 Specifications and dimensions subject to change

RTBV Series 1-2 Pole Coded Rotary Switches

DESIGNATION

RTBV DIMENSIONAL DRAWINGS

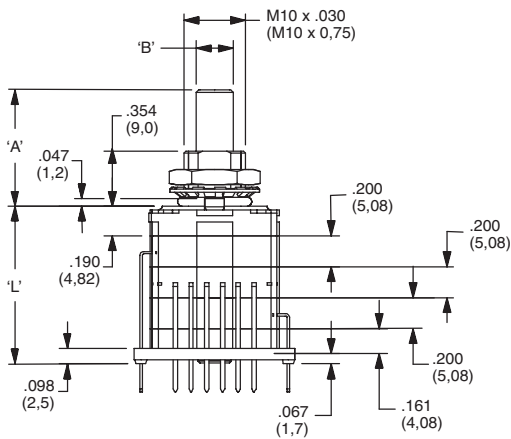
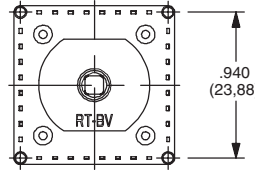
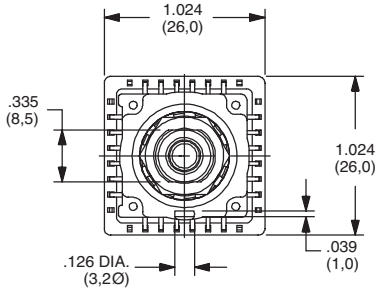

Dimensions L		
Number modules	inch	L mm
1	0.419	10.65
2	0.619	15.73
3	0.819	20.81
4	1.02	25.89

Dimensions A
A: (standard)
0.984 inch (25 mm)

Dimensions B
0.236 or 0.250 inch
(Ø6 or 6.35 mm)

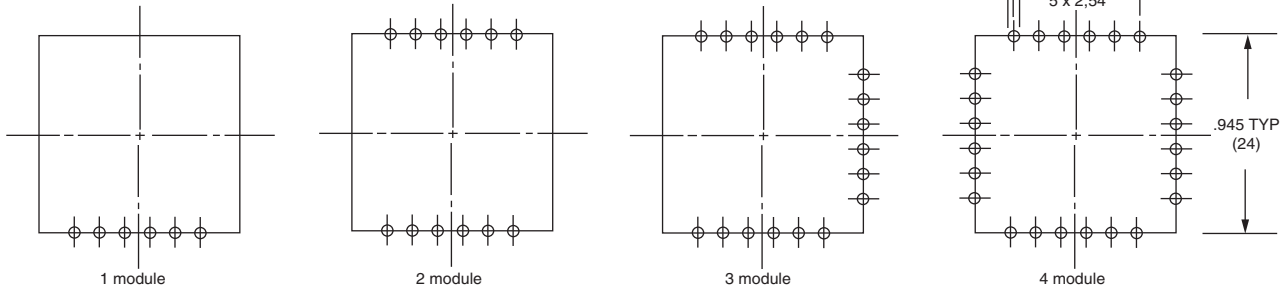

INDEXING

- 1** 15° index/24 positions
- 2** 22.5° index/16 positions
- 3** 30° index/12 positions
- 4** 36° index/10 positions

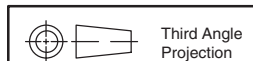

Dimensions are shown: mm
Specifications and dimensions subject to change



K

Rotary

RTBV Series

1-2 Pole Coded Rotary Switches

NUMBER OF BANKS

- 1** 1 BANK
- 2** 2 BANKS
- 3** 3 BANKS
- 4** 4 BANKS

NOTE: Several functions can be combined. For more information consult customer service.

SWITCH FUNCTION

Switch Function Number of Poles or code (binary code = B, complement = C, direct +complement = BC) (first digit), Stop (with=S, without=W), Maximum Position (third & fourth digit)

- | | |
|---|---|
| 1S02 SP, 02 positions with stop | 1S24 SP, 24 positions with stop |
| 1S03 SP, 03 positions with stop | 1W24 SP, 24 positions without stop |
| 1S04 SP, 04 positions with stop | 2S04 DP, 4 positions with stop |
| 1S05 SP, 05 positions with stop | 2S05 DP, 5 positions with stop |
| 1S06 SP, 06 positions with stop | 2S06 DP, 6 positions with stop |
| 1S07 SP, 07 positions with stop | GS_ _ Gray Code with stop (indicate position) |
| 1S10 SP, 10 positions with stop | GW_ _ Gray Code without stop (indicate position) only can be 10,12, 16, 24 based on indexing |
| 1W10 SP, 10 positions without stop | BS_ _ Binary Code with stop (indicate position) |
| 1S11 SP, 11 positions with stop | BW_ _ Binary Code without stop (indicate position) only can be 10,12, 16, 24 based on indexing |
| 1S12 SP, 12 positions with stop | CS_ _ Complement with stop (indicate position) |
| 1W12 SP, 12 positions without stop | CW_ _ Complement without stop (indicate position) only can be 10,12, 16, 24 based on indexing |
| 1S14 SP, 14 positions with stop | ES_ _ Direct+Complement with stop (indicate position) |
| 1S16 SP, 16 positions with stop | EW_ _ Direct+Complement without stop (indicate position) only can be 10,12, 16, 24 based on indexing |
| 1W16 SP, 16 positions without stop | |

1 Single Pole Function 1S10, 1S12, 1S16, 1S24

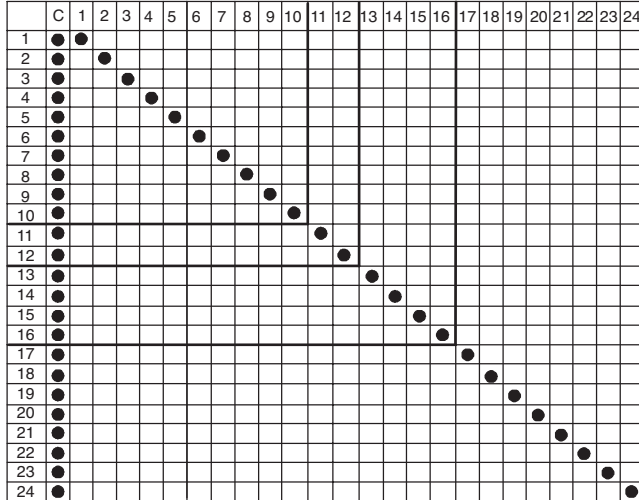

1S10

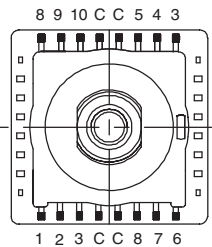

1S12

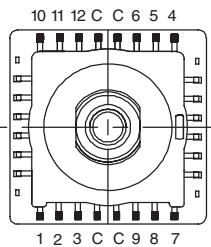

1S16

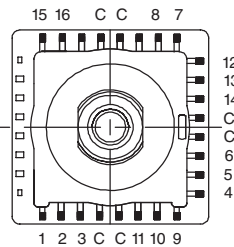

1S24

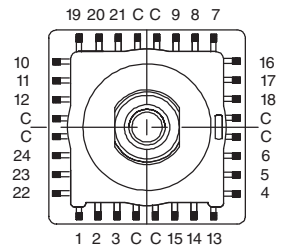

Dimensions are shown: Inch (mm)
Specifications and dimensions subject to change



K

Rotary

RTBV Series 1-2 Pole Coded Rotary Switches

SWITCH FUNCTION

2 DOUBLE POLE FUNCTION

	C ₁	1 ₁	2 ₁	3 ₁	4 ₁	5 ₁	6 ₁	C ₂	1 ₂	2 ₂	3 ₂	4 ₂	5 ₂	6 ₂
1	●	●						●	●					
2	●		●					●		●				
3	●			●				●			●			
4	●				●			●				●		
5	●					●		●					●	
6	●						●	●						●

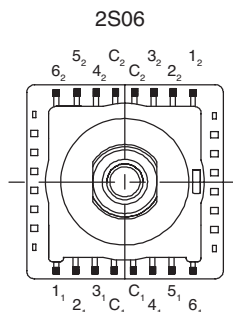

B BINARY DIRECT CODE

	C	1	2	4	8	16
0	●					
1	●	●				
2	●		●			
3	●	●	●			
4	●			●		
5	●	●			●	
6	●	●	●			
7	●	●	●	●		
8	●					●
9	●	●				●
10	●		●			●
11	●	●	●			●
12	●			●		●
13	●	●			●	●
14	●	●	●			●
15	●	●	●	●		●
16	●					●
17	●	●				●
18	●		●			●
19	●	●	●			●
20	●			●		●
21	●	●			●	●
22	●	●	●			●
23	●	●	●	●		●

BS10 BS12 BS16

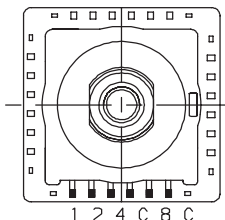

BS24

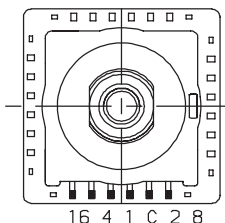

C COMPLEMENT BINARY CODE

	c	1̄	2̄	4̄	8̄	16̄
0	●					
1	●	●	●	●	●	●
2	●		●	●	●	●
3	●	●		●	●	●
4	●			●	●	●
5	●	●	●		●	●
6	●	●	●	●		●
7	●	●	●	●	●	
8	●					●
9	●	●				●
10	●		●			●
11	●	●	●			●
12	●			●		●
13	●	●			●	●
14	●	●	●			●
15	●	●	●	●		●
16	●					●
17	●	●				●
18	●		●			●
19	●	●	●			●
20	●			●		●
21	●	●			●	●
22	●	●	●			●
23	●	●	●	●		●

CS10 CS12 CS16

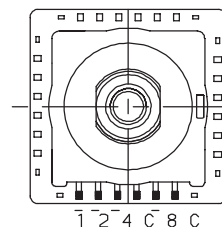

CS24

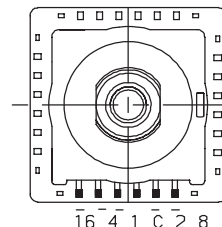

G GRAY CODE

	C	1	2	3	4	5
1	●	●				
2	●		●			
3	●	●	●			
4	●			●		
5	●	●			●	
6	●	●	●			●
7	●		●			●
8	●			●		●
9	●	●			●	●
10	●	●	●			●
11	●		●			●
12	●	●			●	●
13	●	●	●			●
14	●		●			●
15	●	●			●	●
16	●			●		●
17	●	●			●	●
18	●		●			●
19	●	●	●			●
20	●			●		●
21	●	●			●	●
22	●	●	●			●
23	●	●	●	●		●
24	●			●		●

GS10 GS12 GS16

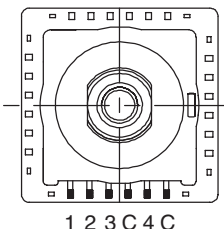

GS24

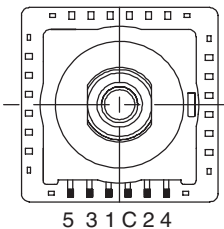

E DIRECT AND COMPLEMENT BINARY CODE

	C	1	2	4	8	16	c	1̄	2̄	4̄	8̄	16̄
0	●						●					
1	●	●					●	●	●	●	●	●
2	●		●				●		●	●	●	●
3	●	●	●				●	●		●	●	●
4	●			●			●			●	●	●
5	●	●			●		●	●			●	●
6	●	●	●				●	●	●			●
7	●	●	●	●			●	●	●	●		●
8	●					●	●					●
9	●	●				●	●	●				●
10	●		●				●		●			●
11	●	●	●				●	●	●			●
12	●			●			●			●		●
13	●	●			●		●	●			●	●
14	●	●	●				●	●	●			●
15	●	●	●	●			●	●	●	●		●
16	●					●	●					●
17	●	●				●	●	●				●
18	●		●				●		●			●
19	●	●	●				●	●	●			●
20	●			●			●			●		●
21	●	●			●		●	●			●	●
22	●	●	●				●	●	●			●
23	●	●	●	●			●	●	●	●		●

ES10 ES12 ES16

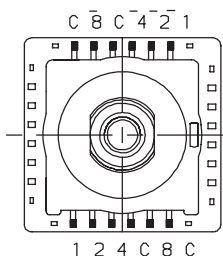

ES24

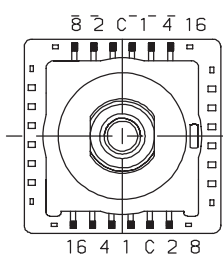

Third Angle
Projection

Dimensions are shown: mm
Specifications and dimensions subject to change

RTBV Series 1-2 Pole Coded Rotary Switches

SEAL

A STANDARD BUSHING FOR PANEL MOUNT

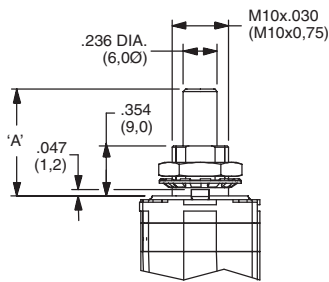

D SEALED BUSHING FOR PANEL MOUNT

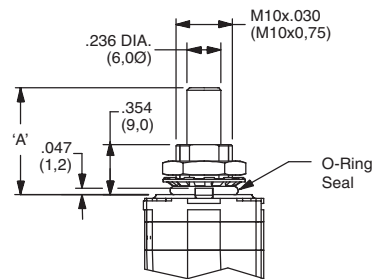

SHAFT DIAMETER & STYLE

N METRIC SHAFT 0.236 (6,0)

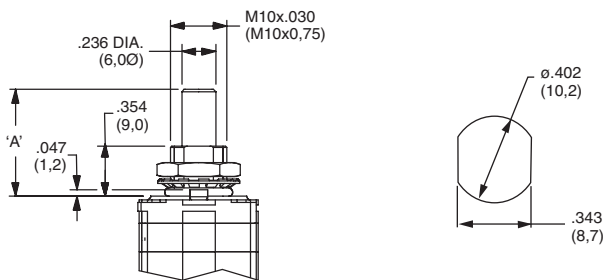

P STANDARD SHAFT 0.250 (6,35)

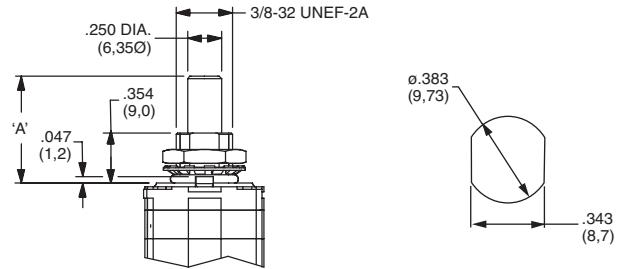

F METRIC SHAFT WITH FLAT 0.236 (6,0)

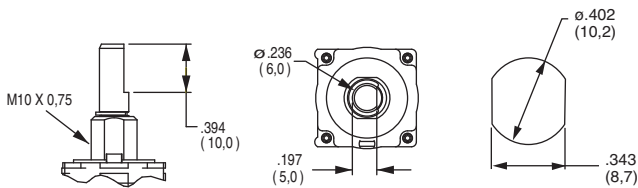

G STANDARD SHAFT WITH FLAT 0.250 (6,35)

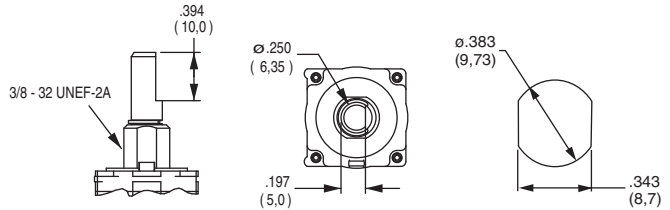

S METRIC SHAFT WITH SLOT 0.236 (6,0)

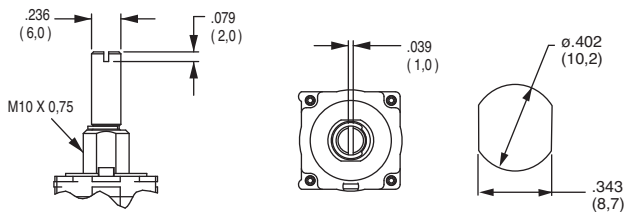

T STANDARD SHAFT WITH SLOT 0.250 (6,35)

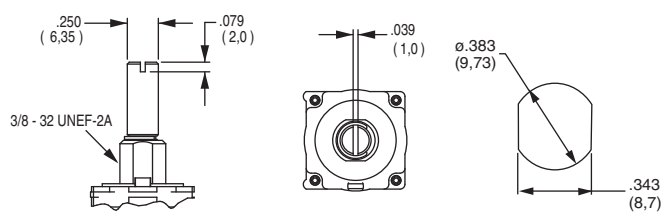

***Note: Metric diameter shafts are only available with metric diameter bushings, standard 1.250 inch diameter shafts are only available with standard 3/8 diameter bushings.



Third Angle
Projection

Dimensions are shown: Inch (mm)
Specifications and dimensions subject to change

RTBV Series 1-2 Pole Coded Rotary Switches

ACTUATOR OPTION ANGLE

SHAFT WITH FLAT OPTIONS

N (None) FOR ACTUATORS WITHOUT A FLAT

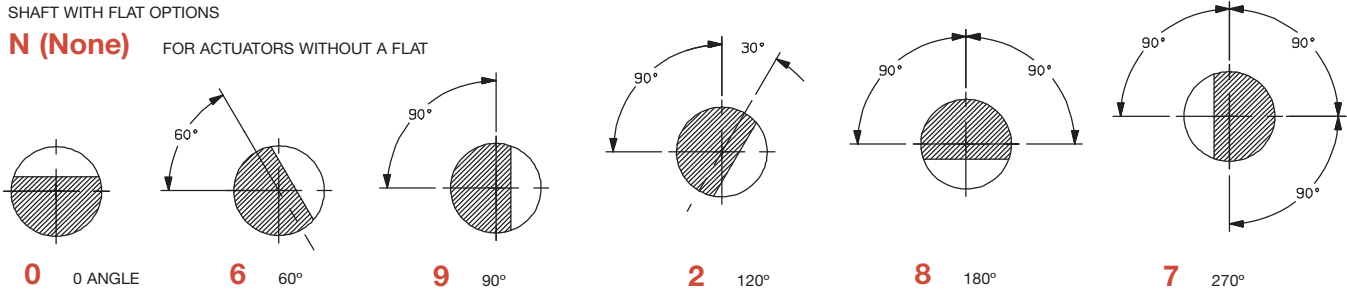

SHAFT WITH SLOT OPTIONS

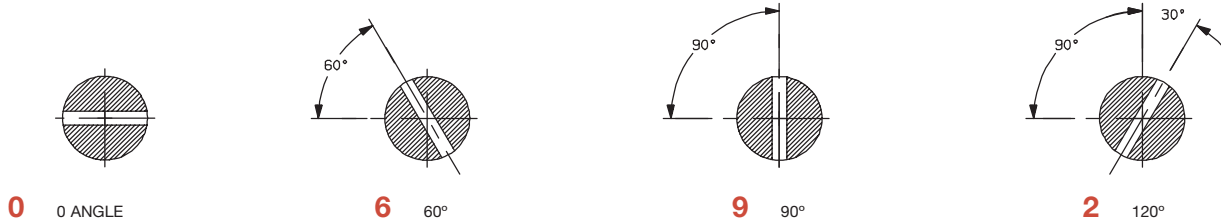

* Note: S&T Shaft Diameter and Style are only available with Actuator Option Angle 0, 6, 9, 2.

ACTUATOR LENGTH

Z (.984) 0,25 mm STANDARD SHAFT

Other lengths available by request.

CONTACT MATERIAL

OPTION CODE	CONTACT AND TERMINAL MATERIAL	RATING
S	SILVER	SWITCH: 250 mA, POWER: 5 VA; CARRY: 5 AMPS
P	GOLD	SWITCH: 20 mA, POWER: 0.2 VA; CARRY: 1 AMP

* Note: See Technical Data section of this catalog for RoHS compliant and compatible definition and specifications.

SWITCHING POWER

S (SILVER CONTACTS)

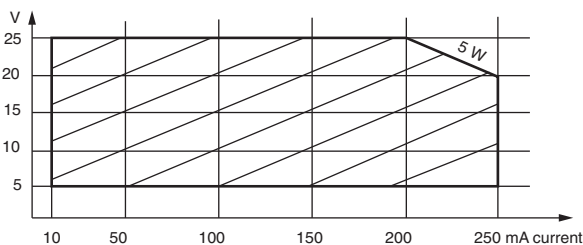

Switching power: 5 W
Max. voltage: 25 V
Min. voltage: 5 V
Max. switching current: 250 mA
Min. switching current: 10 mA

P (GOLD CONTACTS)

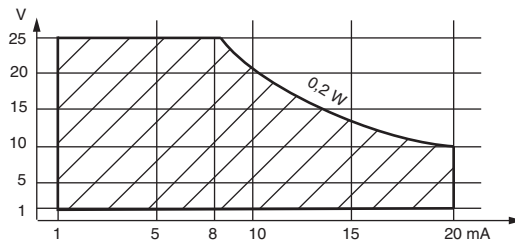

Switching power: 0.2 W
Max. voltage: 25 V
Min. voltage: 1 V
Max. switching current: 20 mA
Min. switching current: 1 mA



Dimensions are shown: mm
Specifications and dimensions subject to change