

Operational Amplifiers / Comparators

Automotive Comparators: Ground Sense



BA2903YF-C, BA2903YFVM-C, BA2901YF-C, BA2901YFV-C

No.11049EBT24

●Description

Automotive series BA2903Y family and BA2901Y family, integrate one, two or four independent high gain voltage comparator.

Some features are the wide operating voltage that is 2 to 36[V] and low supply current.

Therefore, this series is suitable for any application

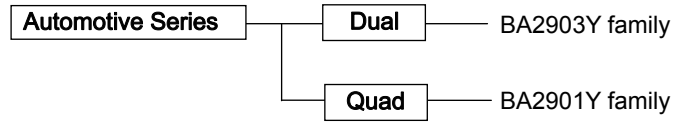

●Features

- 1) Operable with a signal power supply
- 2) Wide operating supply voltage
+2.0[V]~+36.0[V] (single supply)
±1.0[V]~±18.0[V] (split supply)
- 3) Standard comparator pin-assignments
- 4) Input and output are operable ground sense
- 5) Internal ESD protection
Human body model (HBM) ± 5000 [V](Typ.)
- 6) Wide temperature range
-40[°C]~+125[°C]

●Pin Assignment

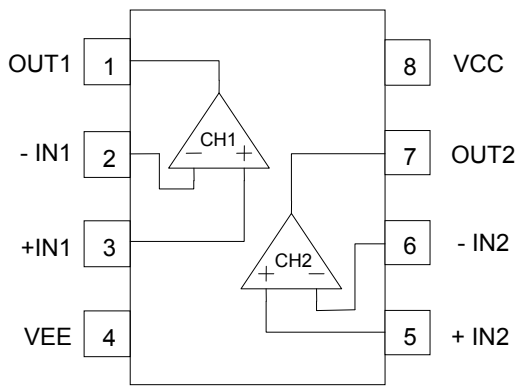

SOP8
BA2903YF-C

MSOP8
BA2903YFVM-C

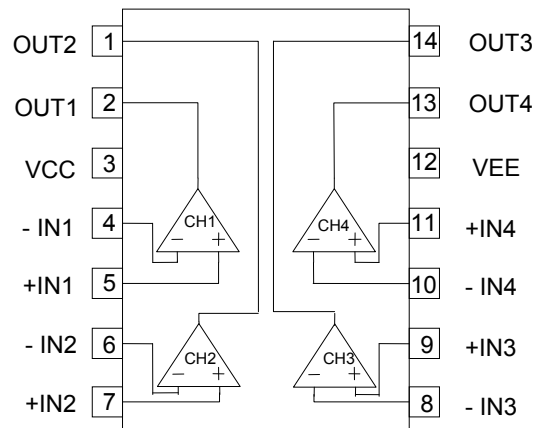

SOP14
BA2901YF-C

SSOP-B14
BA2901YFV-C

●Absolute Maximum Ratings (Ta=25[°C])

OBA2903Y family , BA2901Y family

Parameter	Symbol	Ratings	Unit
		BA2903Y family , BA2901Y family	
Supply Voltage	VCC-VEE	+36	V
Differential Input Voltage ^(*)	Vid	36	V
Input Common-mode Voltage Range	Vicm	(VEE-0.3)~(VEE+36)	V
Operating Temperature Range	Topr	-40~+125	°C
Storage Temperature Range	Tstg	-55~+150	°C
Maximum junction Temperature	Tjmax	+150	°C

Note : Absolute maximum rating item indicates the condition which must not be exceeded.

Application if voltage in excess of absolute maximum rating or use out of absolute maximum rated temperature environment may cause deterioration of characteristics.

(*) The voltage difference between inverting input and non-inverting input is the differential input voltage.
Then input terminal voltage is set to more than VEE.

● Electric Characteristics

OBA2903Y family (Unless otherwise specified VCC=+5[V], VEE=0[V])

Parameter	Symbol	Temperature range	Limits			Unit	Conditions
			Min.	Typ.	Max.		
Input Offset Voltage ^{(*)2}	Vio	25°C	-	2	5	mV	VOUT=1.4[V]
		Full range	-	-	15		VCC=5~36[V], VOUT=1.4[V]
Input Offset Current ^{(*)2}	Iio	25°C	-	5	50	nA	VOUT=1.4[V]
		Full range	-	-	200		
Input Bias Current ^{(*)2}	Ib	25°C	-	50	250	nA	VOUT=1.4[V]
		Full range	-	-	500		
Input Common-mode Voltage Range	Vicm	25°C	0	-	VCC-1.5	V	-
		Full range	0	-	VCC-2.0		
Large Signal Voltage Gain	AV	25°C	88	100	-	dB	VCC=15[V], VOUT=1.4~11.4[V] RL=15[kΩ], VRL=15[V]
		Full range	74	-	-		
Supply Current	ICC	25°C	-	0.6	1	mA	VOUT=open
		Full range	-	-	2.5		VOUT=open, VCC=36[V]
Output Sink Current ^{(*)3}	IOL	25°C	6	16	-	mA	VIN+=0[V], VIN-=1[V], VOL=1.5[V]
Output Saturation Voltage (Low level output voltage)	VOL	25°C	-	150	400	mV	VIN+=0[V], VIN-=1[V], IOL=4[mA]
		Full range	-	-	700		
Output Leakage Current (High level output voltage)	Ileak	25°C	-	0.1	-	μA	VIN+=1[V], VIN-=0[V], VOH=5[V]
		Full range	-	-	1		VIN+=1[V], VIN-=0[V], VOH=36[V]
Operable Frequency	Fopr	25°C	100	-	-	kHz	VCC=5[V], RL=2[kΩ], VIN+=1.5[V], VIN-=5[Vp-p] (Duty 50% Rectangular Pulse)

(*)2 Absolute value

(*)3 Under high temperatures, please consider the power dissipation when selecting the output current.

When the output terminal is continuously shorted the output current reduces the internal temperature by flushing.

OBA2901Y family (Unless otherwise specified VCC=+5[V], VEE=0[V])

Parameter	Symbol	Temperature range	Limits			Unit	Conditions
			Min.	Typ.	Max.		
Input Offset Voltage ^(*4)	Vio	25°C	-	2	5	mV	VOUT=1.4[V]
		Full range	-	-	15		VCC=5~36[V], VOUT=1.4[V]
Input Offset Current ^(*4)	Iio	25°C	-	5	50	nA	VOUT=1.4[V]
		Full range	-	-	200		
Input Bias Current ^(*4)	Ib	25°C	-	50	250	nA	VOUT=1.4[V]
		Full range	-	-	500		
Input Common-mode Voltage Range	Vicm	25°C	0	-	VCC-1.5	V	-
		Full range	0	-	VCC-2.0		
Large Signal Voltage Gain	AV	25°C	88	100	-	dB	VCC=15[V], VOUT=1.4~11.4[V] RL=15[kΩ], VRL=15[V]
		Full range	74	-	-		
Supply Current	ICC	25°C	-	0.8	2	mA	VOUT=open
		Full range	-	-	2.5		VOUT=open, VCC=36[V]
Output Sink Current ^(*5)	IOL	25°C	6	16	-	mA	VIN+=0[V], VIN-=1[V], VOL=1.5[V]
Output Saturation Voltage (Low level output voltage)	VOL	25°C	-	150	400	mV	VIN+=0[V], VIN-=1[V], IOL=4[mA]
		Full range	-	-	700		
Output Leakage Current (High level output voltage)	Ileak	25°C	-	0.1	-	μA	VIN+=1[V], VIN-=0[V], VOH=5[V]
		Full range	-	-	1		VIN+=1[V], VIN-=0[V], VOH=36[V]
Operable Frequency	Fopr	25°C	100	-	-	kHz	VCC=5[V], RL=2[kΩ], VIN+=1.5[V], VIN-=5[Vp-p] (Duty 50% Rectangular Pulse)

(*4) Absolute value

(*5) Under high temperatures, please consider the power dissipation when selecting the output current.

When the output terminal is continuously shorted the output current reduces the internal temperature by flushing.

●Reference Data BA2903Y family

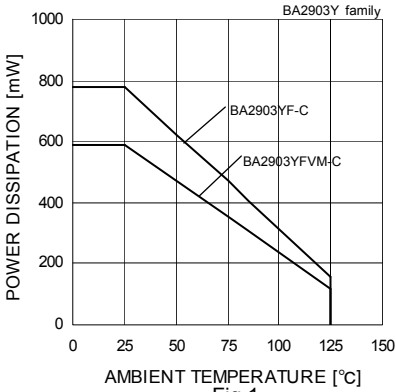

Derating Curve

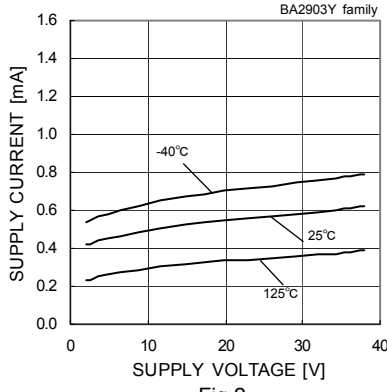

Supply Current - Supply Voltage

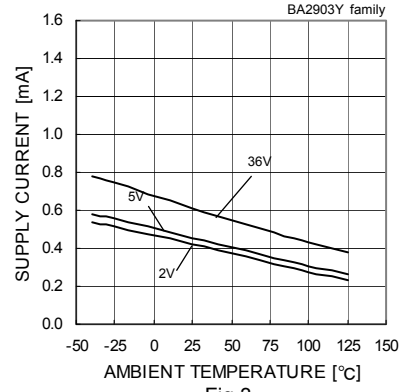

Supply Current - Ambient Temperature

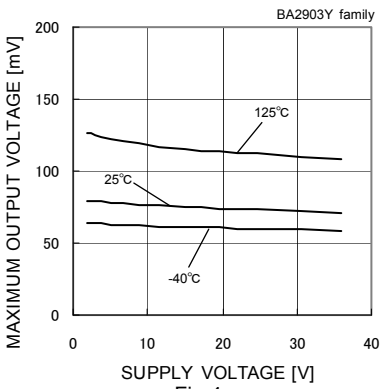

Maximum Output Voltage - Supply Voltage (IOL=4[mA])

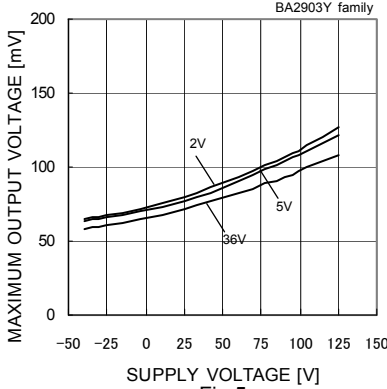

Maximum Output Voltage - Ambient Temperature (IOL=4[mA])

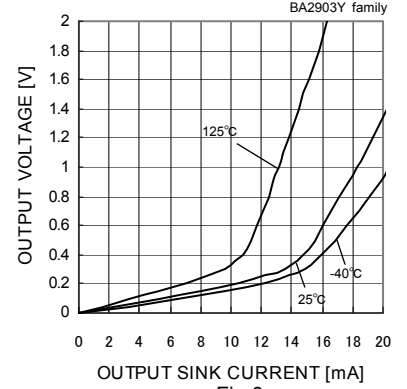

Output Voltage - Output Sink Current (VCC=5[V])

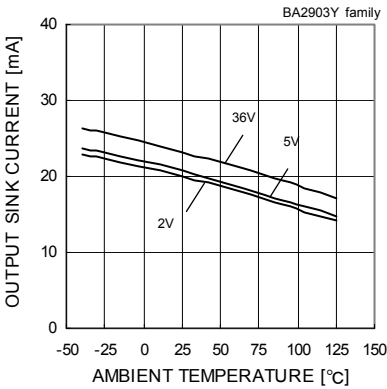

Output Sink Current - Ambient Temperature (VOUT=1.5[V])

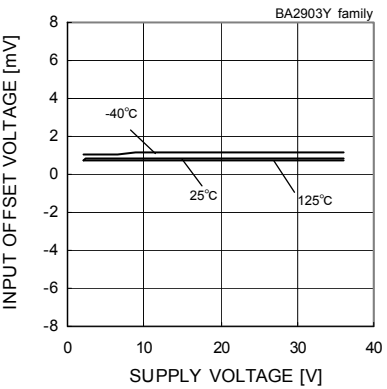

Input Offset Voltage - Supply Voltage

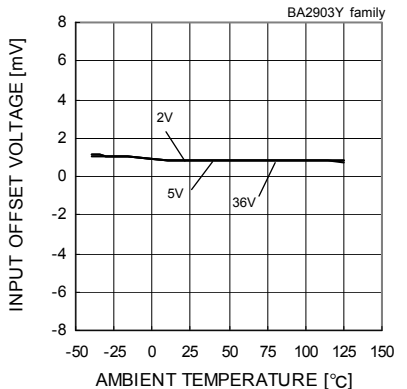

Input Offset Voltage - Ambient Temperature

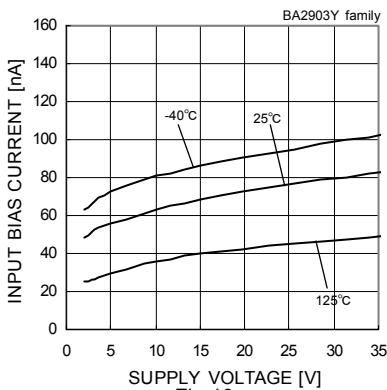

Input Bias Current - Supply Voltage

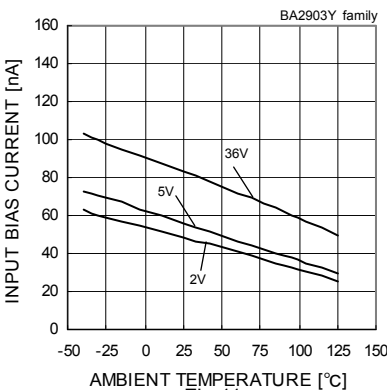

Input Bias Current - Ambient Temperature

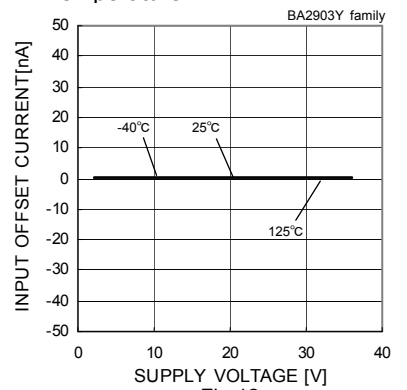

Input Offset Current - Supply Voltage

(*)The data above is ability value of sample, it is not guaranteed.

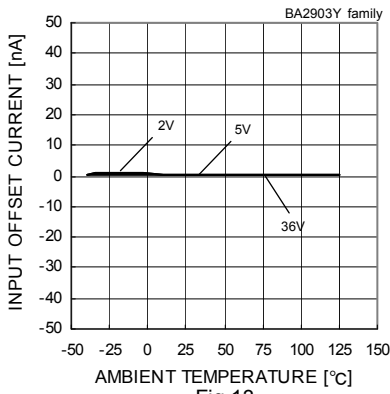

Fig. 13
Input Offset Current
– Ambient Temperature

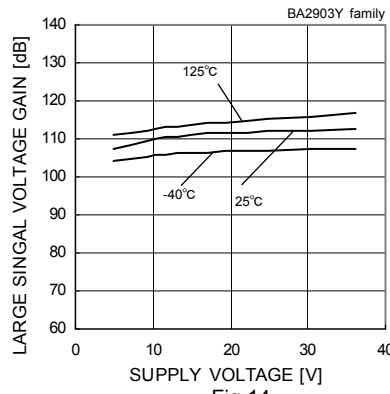

Fig. 14
Large Signal Voltage Gain
– Supply Voltage

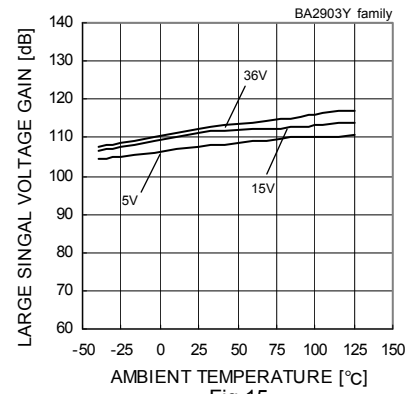

Fig. 15
Large Signal Voltage Gain
– Ambient Temperature

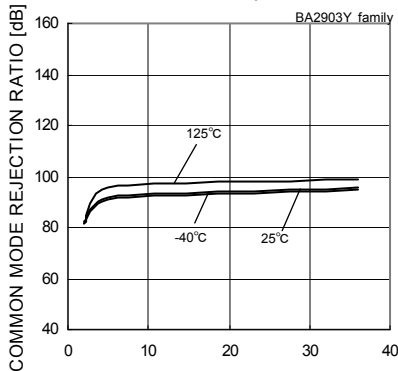

Fig. 16
Common Mode Rejection Ratio
– Supply Voltage

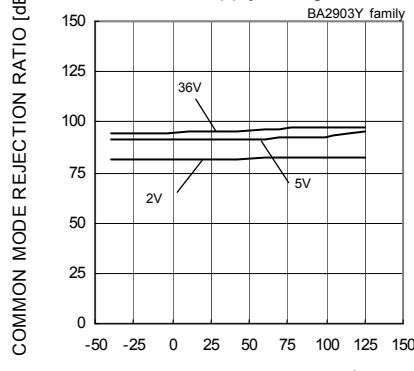

Fig. 17
Common Mode Rejection Ratio
– Ambient Temperature

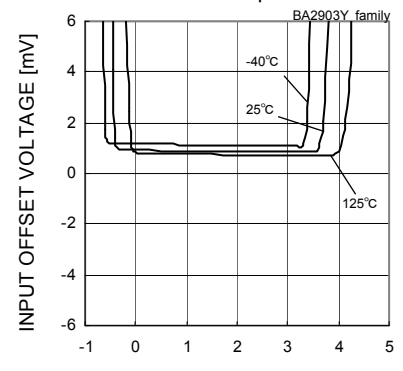

Fig. 18
Input Offset Voltage – Input Voltage
(VCC=5V)

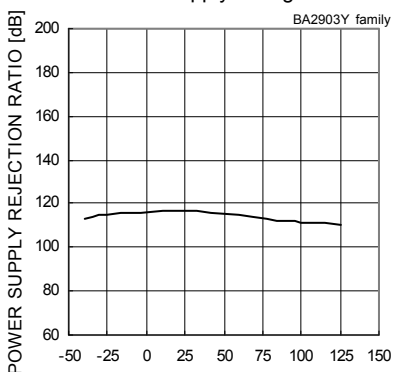

Fig. 19
Power Supply Rejection Ratio
– Ambient Temperature

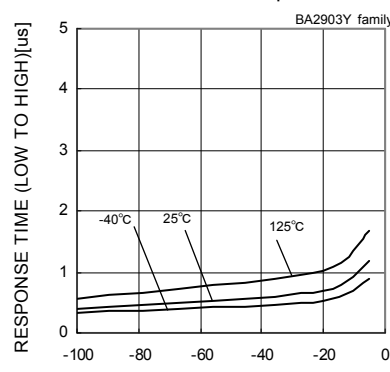

Fig. 20
Response Time (Low to High) – Over Drive Voltage
(VCC=5[V],VRL=5[V],RL=5.1[kΩ])

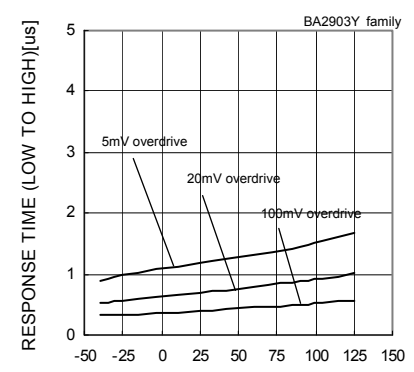

Fig. 21
Response Time (Low to High)
– Ambient Temperature
(VCC=5[V],VRL=5[V],RL=5.1[kΩ])

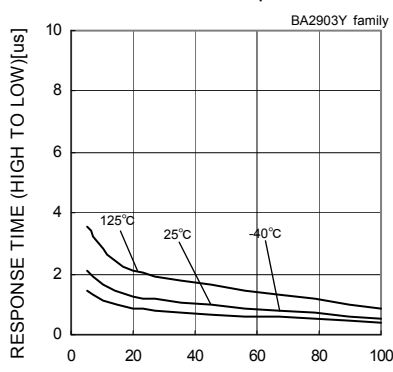

Fig. 22
Response Time (High to Low)
– Over Drive Voltage
(VCC=5[V],VRL=5[V],RL=5.1[kΩ])

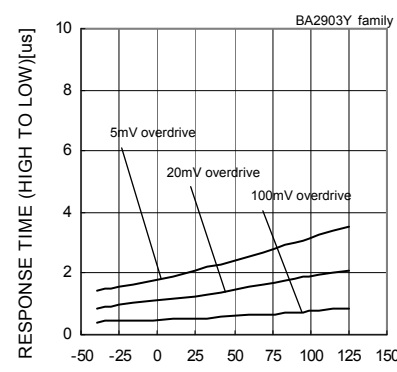

Fig. 23
Response Time (High to Low)
– Ambient Temperature
(VCC=5[V],VRL=5[V],RL=5.1[kΩ])

(*)The data above is ability value of sample, it is not guaranteed.

●Reference Data BA2901Y family

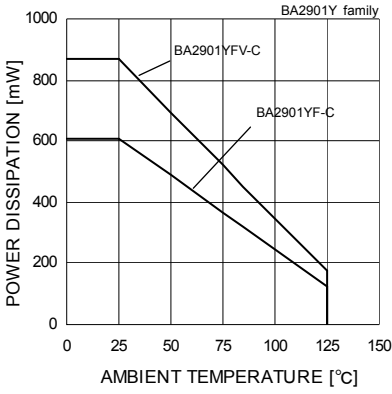

Fig.24 Derating Curve

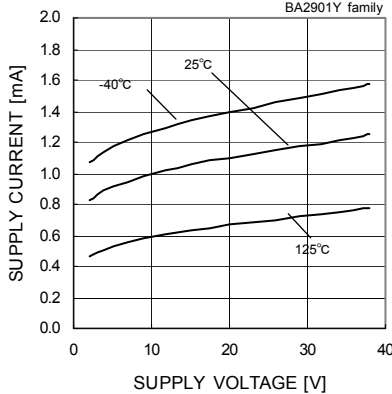

Fig.25 Supply Current - Supply Voltage

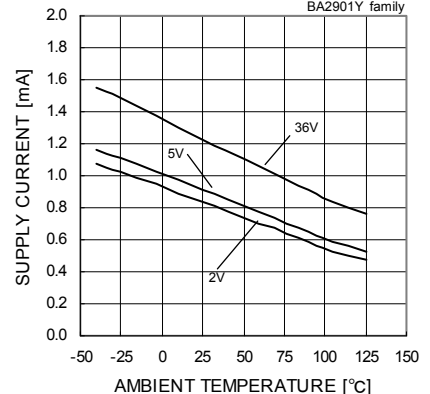

Fig.26 Supply Current - Ambient Temperature

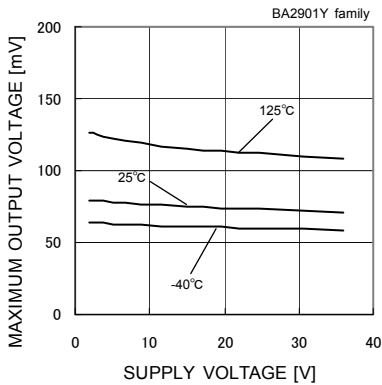

Fig.27 Maximum Output Voltage - Supply Voltage (IOL=4[mA])

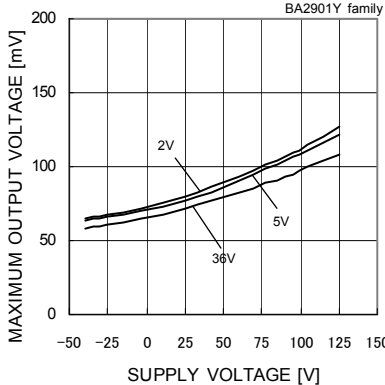

Fig.28 Maximum Output Voltage - Supply Voltage (IOL=4[mA])

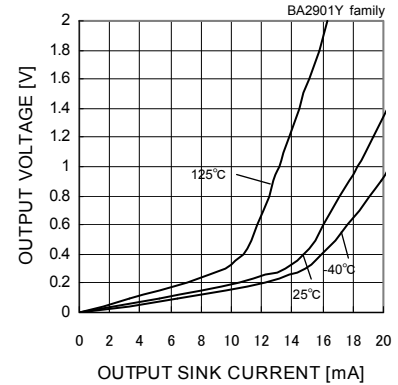

Fig.29 Output Voltage - Output Sink Current (VCC=5[V])

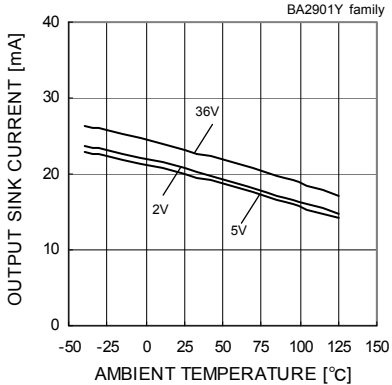

Fig.30 Output Sink Current - Ambient Temperature (VOUT=1.5[V])

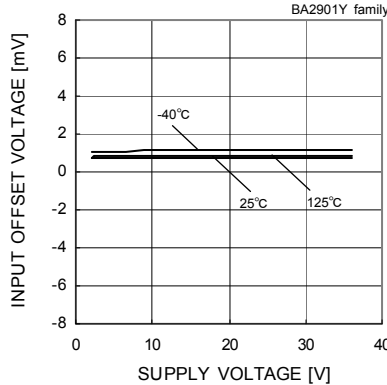

Fig.31 Input Offset Voltage - Supply Voltage

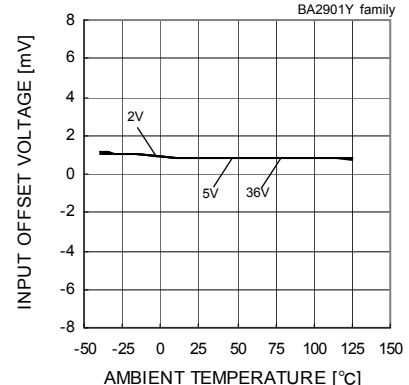

Fig.32 Input Offset Voltage - Ambient Temperature

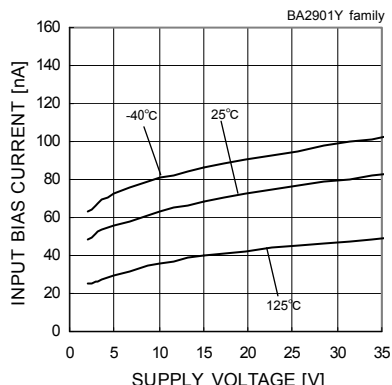

Fig.33 Input Bias Current - Supply Voltage

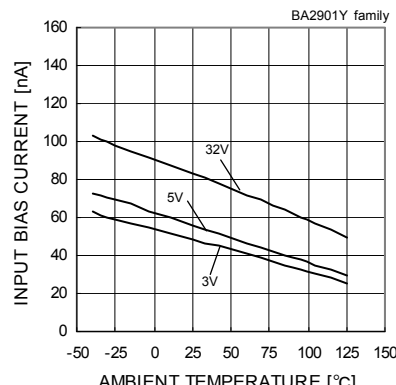

Fig.34 Input Bias Current - Ambient Temperature

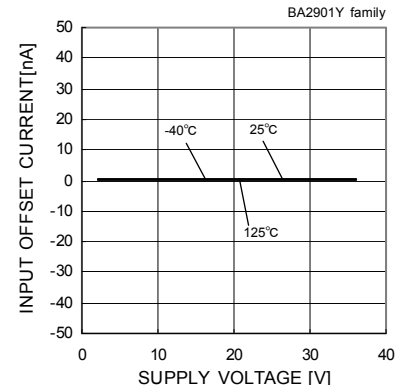
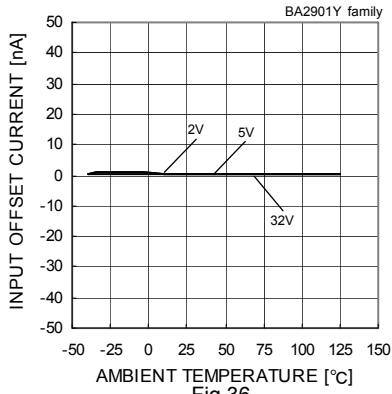
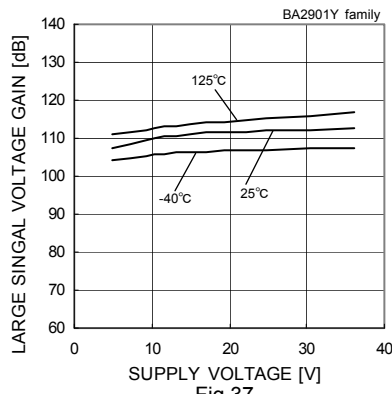

Fig.35 Input Offset Current - Supply Voltage

(*)The data above is ability value of sample, it is not guaranteed.



Input Offset Current
– Ambient Temperature



Large Signal Voltage Gain
– Supply Voltage

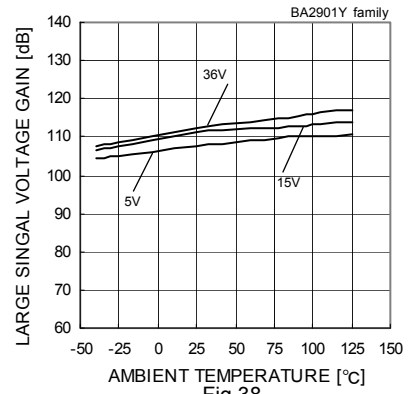

Large Signal Voltage Gain
– Ambient Temperature

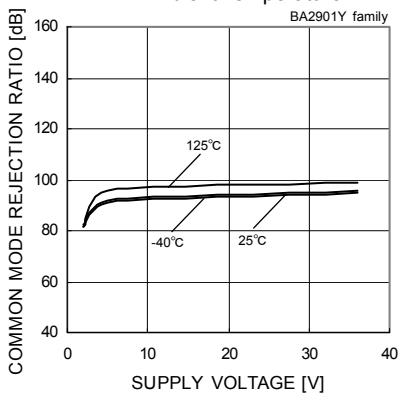

Common Mode Rejection Ratio
– Supply Voltage

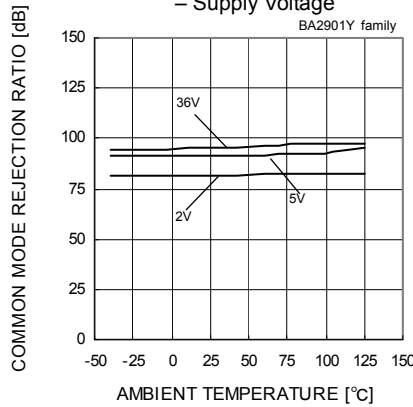

Power Supply Rejection Ratio
– Ambient Temperature

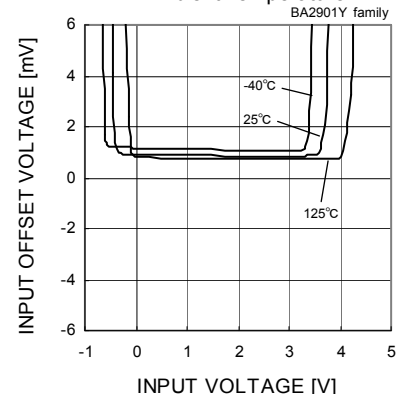

Input Offset Voltage – Input Voltage
(VCC=5[V])

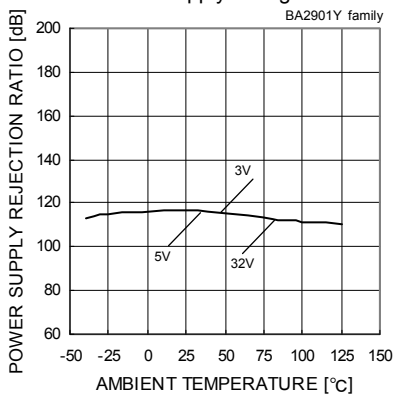

Power Supply Rejection Ratio
– Ambient Temperature

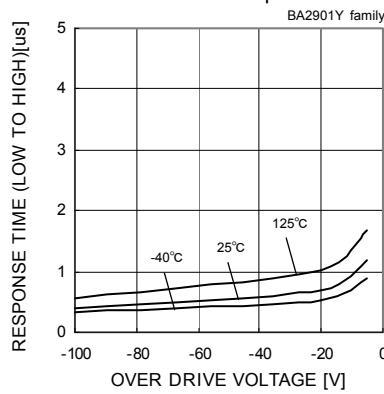

Response Time (Low to High)– Over Drive Voltage
(VCC=5[V],VRL=5[V],RL=5.1[kΩ])

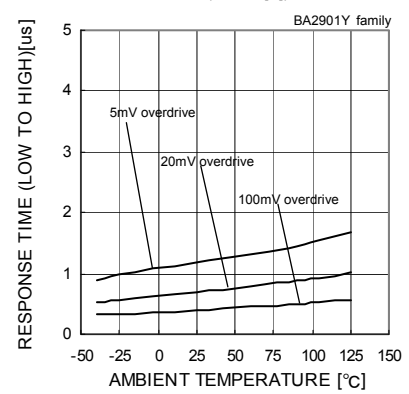

Response Time (Low to High)
– Ambient Temperature
(VCC=5[V],VRL=5[V],RL=5.1[kΩ])

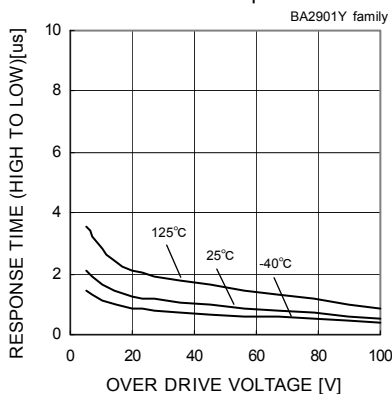

Response Time (High to Low)
– Over Drive Voltage
(VCC=5[V],VRL=5[V],RL=5.1[kΩ])

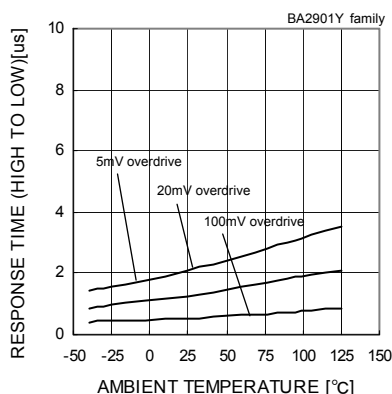

Response Time (High to Low)
– Ambient Temperature
(VCC=5[V],VRL=5[V],RL=5.1[kΩ])

(*The data above is ability value of sample, it is not guaranteed.

●Circuit Diagram

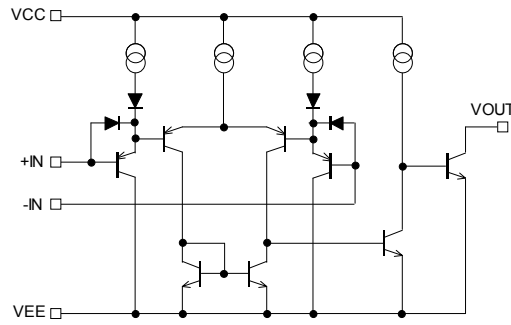

BA2903Y / BA2901Y Schematic Diagram
Fig.47 Schematic Diagram (one channel only)

●Test Circuit 1 Null Method

VCC,VEE,EK,Vicm Unit : [V]

Parameter	VF	S1	S2	S3	BA2903Y family BA2901Y family				Calculation
					Vcc	VEE	EK	Vicm	
Input Offset Voltage	VF1	ON	ON	ON	5~36	0	-1.4	0	1
Input Offset Current	VF2	OFF	OFF	ON	5	0	-1.4	0	2
Input Bias Current	VF3	OFF	ON	ON	5	0	-1.4	0	3
	VF4	ON	OFF		5	0	-1.4	0	
Large Signal Voltage Gain	VF5	ON	ON	ON	15	0	-1.4	0	4
	VF6				15	0	-11.4	0	

- Calculation -

1. Input Offset Voltage (Vio)

$$V_{io} = \frac{|VF1|}{1 + R_f / R_s} \text{ [V]}$$

2. Input Offset Current (Iio)

$$I_{io} = \frac{|VF2 - VF1|}{R_i \times (1 + R_f / R_s)} \text{ [A]}$$

3. Input Bias Current (Ib)

$$I_b = \frac{|VF4 - VF3|}{2 \times R_i \times (1 + R_f / R_s)} \text{ [A]}$$

4. Large Signal Voltage Gain (AV)

$$A_v = 20 \times \text{Log} \frac{\Delta E_K \times (1 + R_f / R_s)}{|VF5 - VF6|} \text{ [dB]}$$

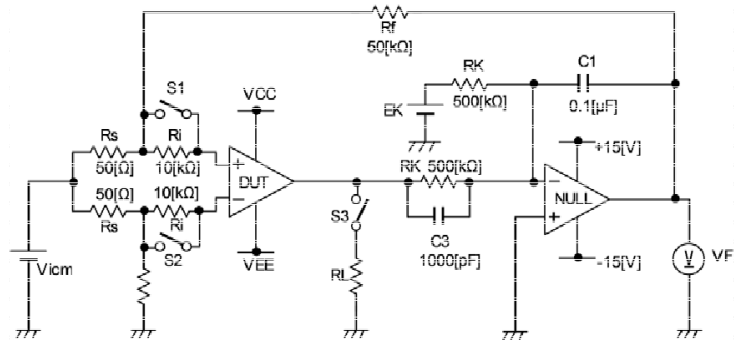

Fig.48 Test circuit1 (one channel only)

● Test Circuit 2: Switch Condition

SW No.		SW 1	SW 2	SW 3	SW 4	SW 5	SW 6	SW 7
Supply Current		OFF	OFF	OFF	OFF	OFF	OFF	OFF
Output Sink Current	VOL=1.5[V]	OFF	ON	ON	OFF	OFF	OFF	ON
Saturation Voltage	IOL=4[mA]	OFF	ON	ON	OFF	ON	ON	OFF
Output Leakage Current	VOH=36[V]	OFF	ON	ON	OFF	OFF	OFF	ON
Response Time	RL=5.1[kΩ], VRL=5[V]	ON	OFF	ON	ON	OFF	OFF	OFF

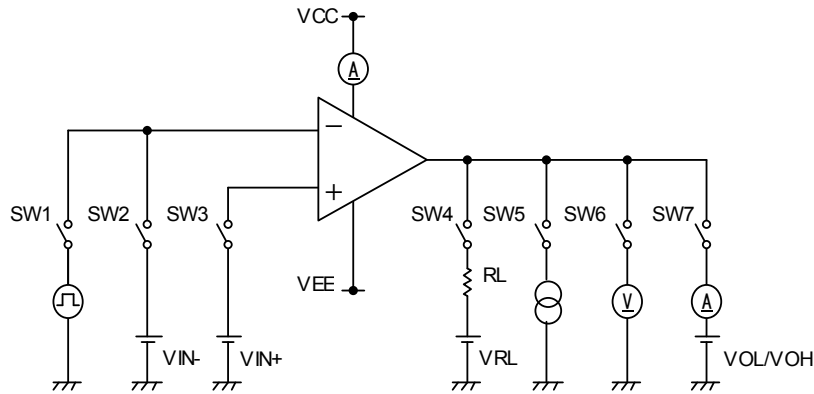

Fig.49 Test Circuit 2 (one channel only)

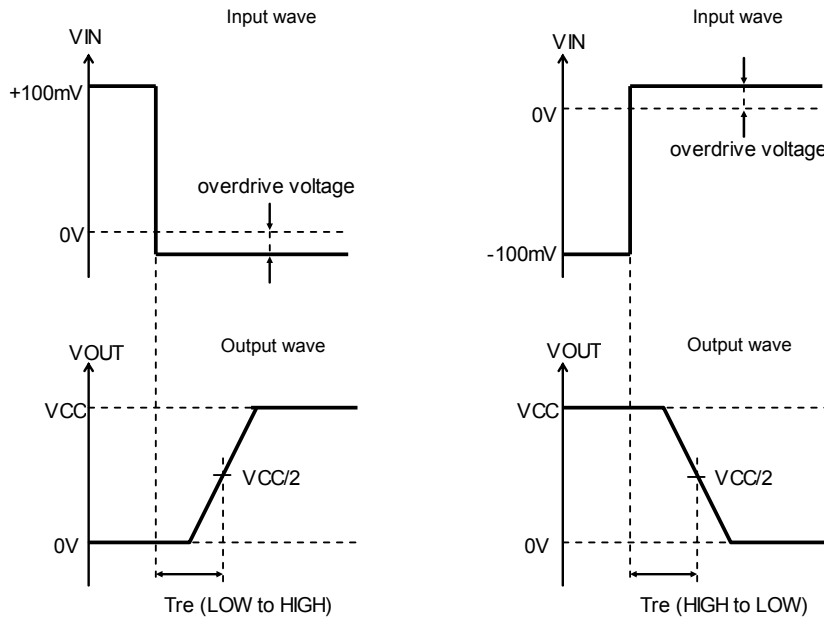
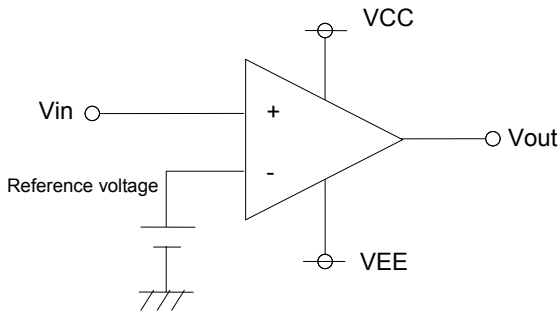

Fig.50 Response Time

●Example of circuit

○Reference voltage is V_{in-}



While input voltage is bigger than reference voltage, output voltage is high. While input voltage is smaller than reference voltage, output voltage is low.

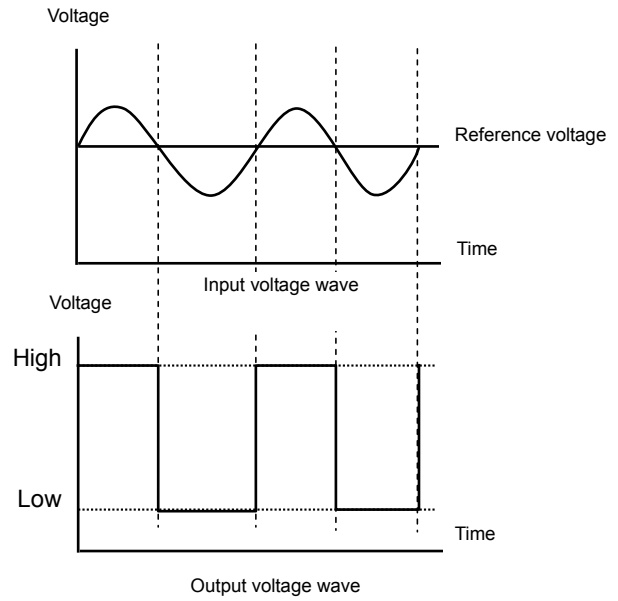

○Reference voltage is V_{in+}

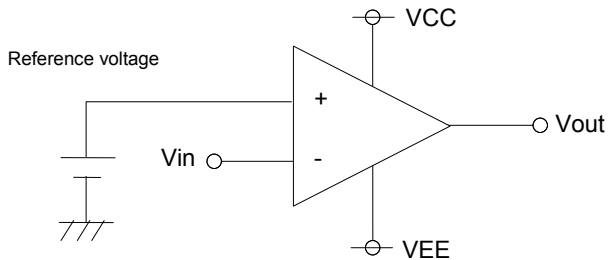

While input voltage is smaller than reference voltage, output voltage is high. While input voltage is bigger than reference voltage, output voltage is low.

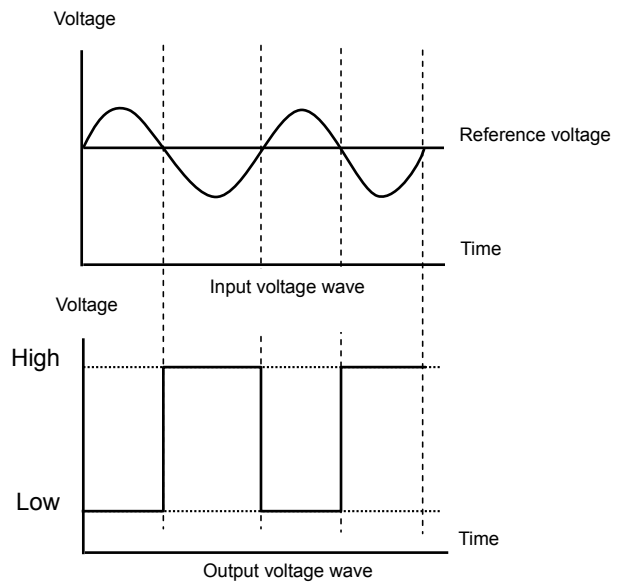

●Derating curves

Power dissipation(total loss) indicates the power that can be consumed by IC at Ta=25°C(normal temperature).IC is heated when it consumed power, and the temperature of IC chip becomes higher than ambient temperature. The temperature that can be accepted by IC chip depends on circuit configuration, manufacturing process, and consumable power is limited. Power dissipation is determined by the temperature allowed in IC chip (maximum junction temperature) and thermal resistance of package (heat dissipation capability). The maximum junction temperature is typically equal to the maximum value in the storage temperature range. Heat generated by consumed power of IC radiates from the mold resin or lead frame of the package. The parameter which indicates this heat dissipation capability(hardness of heat release)is called thermal resistance, represented by the symbol θ_{ja} [°C/W].The temperature of IC inside the package can be estimated by this thermal resistance. Fig.51(a) shows the model of thermal resistance of the package. Thermal resistance θ_{ja} , ambient temperature Ta, junction temperature Tj, and power dissipation Pd can be calculated by the equation below

$$\theta_{ja} = (T_j - T_a) / P_d \quad [^{\circ}\text{C}/\text{W}] \quad \dots \dots \dots (I)$$

Derating curve in Fig.51(b) indicates power that can be consumed by IC with reference to ambient temperature. Power that can be consumed by IC begins to attenuate at certain ambient temperature. This gradient is determined by thermal resistance θ_{ja} . Thermal resistance θ_{ja} depends on chip size, power consumption, package, ambient temperature, package condition, wind velocity, etc even when the same of package is used. Thermal reduction curve indicates a reference value measured at a specified condition. Fig.52(c),(d) show a derating curve for an example of BA2903Y, BA2901Y.

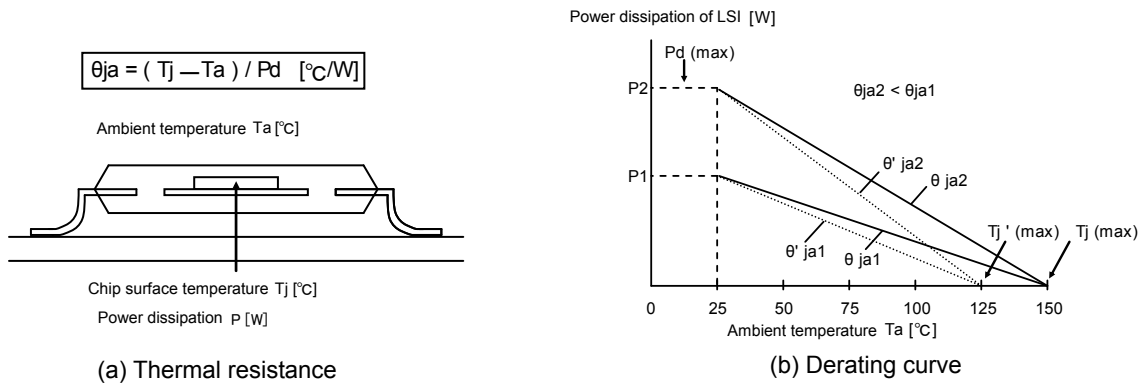
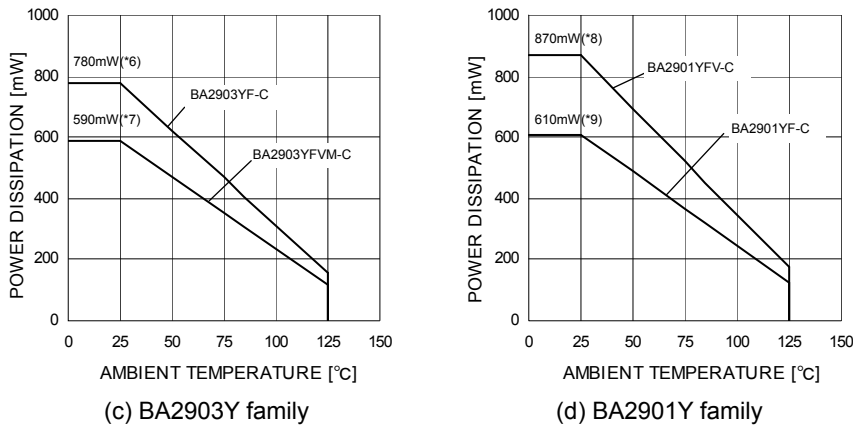

Fig.51 Thermal resistance and derating curve



(*6)	(*7)	(*8)	(*9)	Unit
6.2	4.8	7.0	4.9	[mW/°C]

When using the unit above Ta=25[°C], subtract the value above per degree[°C].
Permissible dissipation is the value when FR4 glass epoxy board 70[mm]×70[mm]×1.6[mm](cooper foil area below 3[%]) is mounted.

Fig. 52 Derating curve

●Description of electrical characteristics

Described below are descriptions of the relevant electrical terms.

Please note that item names, symbols, and their meanings may differ from those on another manufacturer's documents.

1.Absolute maximum ratings

The absolute maximum ratings are values that should never be exceeded, since doing so may result in deterioration of electrical characteristics or damage to the part itself as well as peripheral components.

1.1 Power supply voltage (VCC/VEE)

Expresses the maximum voltage that can be supplied between the positive and negative power supply terminals without causing deterioration of the electrical characteristics or destruction of the internal circuitry.

1.2 Differential input voltage (V_{id})

Indicates the maximum voltage that can be supplied between the non-inverting and inverting terminals without damaging the IC.

1.3 Input common-mode voltage range (V_{icm})

Signifies the maximum voltage that can be supplied to non-inverting and inverting terminals without causing deterioration of the electrical characteristics or damage to the IC itself. Normal operation is not guaranteed within the input common-mode voltage range of the maximum ratings – use within the input common-mode voltage range of the electric characteristics instead.

1.4 Operating and storage temperature ranges (T_{opr}, T_{stg})

The operating temperature range indicates the temperature range within which the IC can operate. The higher the ambient temperature, the lower the power consumption of the IC. The storage temperature range denotes the range of temperatures the IC can be stored under without causing excessive deterioration of the electrical characteristics.

1.5 Power dissipation (P_d)

Indicates the power that can be consumed by a particular mounted board at ambient temperature (25°C).

For packaged products, P_d is determined by maximum junction temperature and the thermal resistance.

2.Electrical characteristics**2.1 Input offset voltage (V_{io})**

Signifies the voltage difference between the non-inverting and inverting terminals. It can be thought of as the input voltage difference required for setting the output voltage to 0V.

2.2 Input offset current (I_{io})

Indicates the difference of the input bias current between the non-inverting and inverting terminals.

2.3 Input bias current (I_b)

Denotes the current that flows into or out of the input terminal, it is defined by the average of the input bias current at the non-inverting terminal and the input bias current at the inverting terminal.

2.4 Input common-mode voltage range (V_{icm})

Indicates the input voltage range under which the IC operates normally.

2.5 Large signal voltage gain (A_V)

The amplifying rate (gain) of the output voltage against the voltage difference between the non-inverting and inverting terminals, it is (normally) the amplifying rate (gain) with respect to DC voltage.

$A_V = (\text{output voltage fluctuation}) / (\text{input offset fluctuation})$

2.6 Circuit current (I_{CC})

Indicates the current of the IC itself that flows under specific conditions and during no-load steady state.

2.7 Output sink current (I_{OL})

Denotes the maximum current that can be output under specific output conditions.

2.8 Output saturation voltage low level output voltage (V_{OL})

Signifies the voltage range that can be output under specific output conditions.

2.9 Output leakage current, High level output current (I_{leak})

Indicates the current that flows into the IC under specific input and output conditions.

2.10 Response time (T_{re})

The interval between the application of input and output conditions.

●Notes for use

- 1) Unused circuits
When there are unused circuits it is recommended that they be connected as in Fig.53, setting the non-inverting input terminal to a potential within the in-phase input voltage range (VICR).
- 2) Input terminal voltage
Applying VEE + 36V to the input terminal is possible without causing deterioration of the electrical characteristics or destruction, irrespective of the supply voltage. However, this does not ensure normal circuit operation. Please note that the circuit operates normally only when the input voltage is within the common mode input voltage range of the electric characteristics.
- 3) Power supply (signal / dual)
The op-amp operates when the specified voltage supplied is between VCC and VEE. Therefore, the signal supply op-amp can be used as a dual supply op-amp as well.
- 4) Power dissipation Pd
Using the unit in excess of the rated power dissipation may cause deterioration in electrical characteristics due to a rise in chip temperature, including reduced current capability. Therefore, please take into consideration the power dissipation (Pd) under actual operating conditions and apply a sufficient margin in thermal design. Refer to the thermal derating curves for more information.
- 5) Short-circuit between pins and erroneous mounting
Incorrect mounting may damage the IC. In addition, the presence of foreign particles between the outputs, the output and the power supply, or the output and GND may result in IC destruction.
- 6) Terminal short-circuits
When the output and VCC terminals are shorted, excessive output current may flow, resulting in undue heat generation and, subsequently, destruction.
- 7) Operation in a strong electromagnetic field
Operation in a strong electromagnetic field may cause malfunctions.
- 8) Radiation
This IC is not designed to withstand radiation.
- 9) IC handling
Applying mechanical stress to the IC by deflecting or bending the board may cause fluctuations in the electrical characteristics due to piezoelectric (piezo) effects.
- 10) Board inspection
Connecting a capacitor to a pin with low impedance may stress the IC. Therefore, discharging the capacitor after every process is recommended. In addition, when attaching and detaching the jig during the inspection phase, ensure that the power is turned off before inspection and removal. Furthermore, please take measures against ESD in the assembly process as well as during transportation and storage

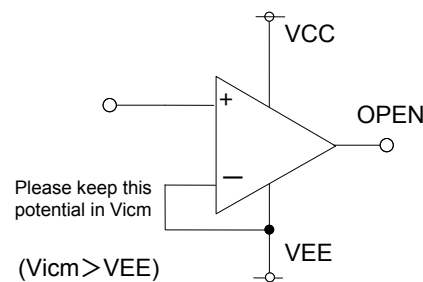
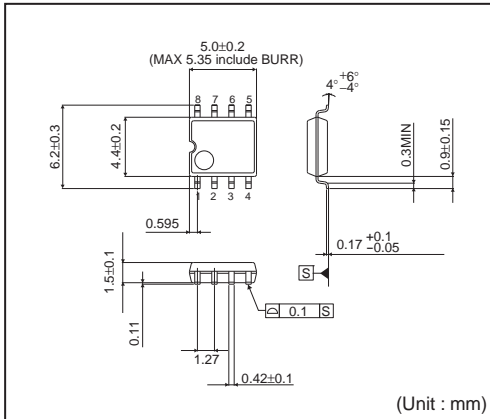

Fig. 53 Disable circuit example

●Ordering part number

B	A	2	9	0	1	Y	F	V	-	C	E	2
Part No.		Part No. 2903Y 2901Y					Package F : SOP8 SOP14 FV : SSOP-B14 FVM : MSOP8		Automotive series		Packaging and forming specification E2: Embossed tape and reel (SOP8/SOP14/ SSOP-B14) TR: Embossed tape and reel (MSOP8)	

SOP8



<Tape and Reel information>

Tape	Embossed carrier tape
Quantity	2500pcs
Direction of feed	E2 (The direction is the 1pin of product is at the upper left when you hold reel on the left hand and you pull out the tape on the right hand)

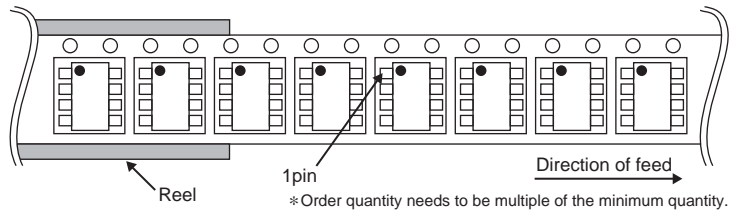

SOP14

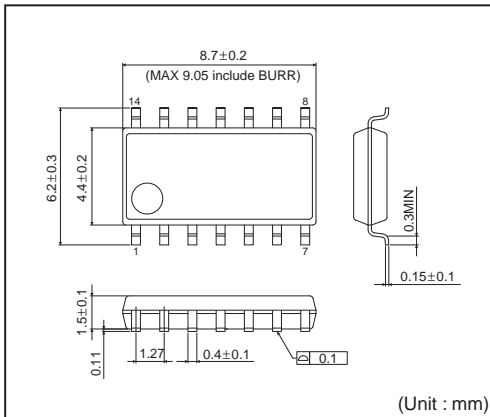

<Tape and Reel information>

Tape	Embossed carrier tape
Quantity	2500pcs
Direction of feed	E2 (The direction is the 1pin of product is at the upper left when you hold reel on the left hand and you pull out the tape on the right hand)

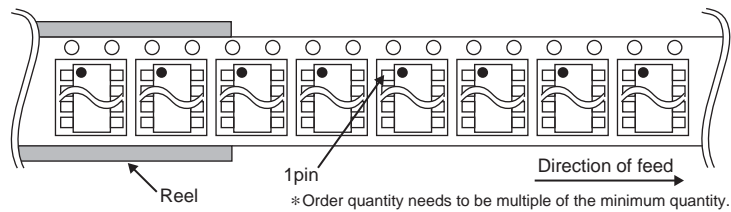

SSOP-B14

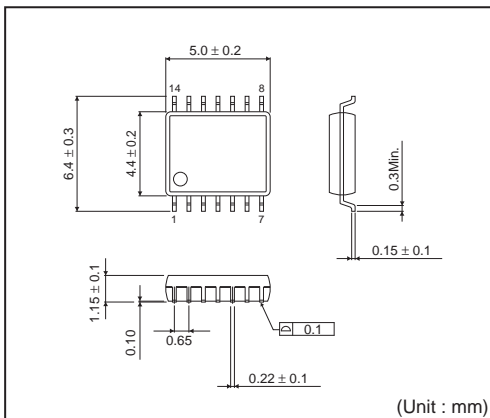

<Tape and Reel information>

Tape	Embossed carrier tape
Quantity	2500pcs
Direction of feed	E2 (The direction is the 1pin of product is at the upper left when you hold reel on the left hand and you pull out the tape on the right hand)

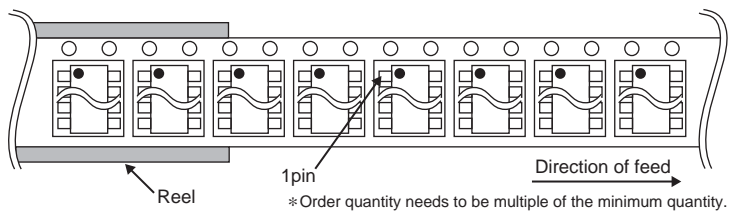

MSOP8

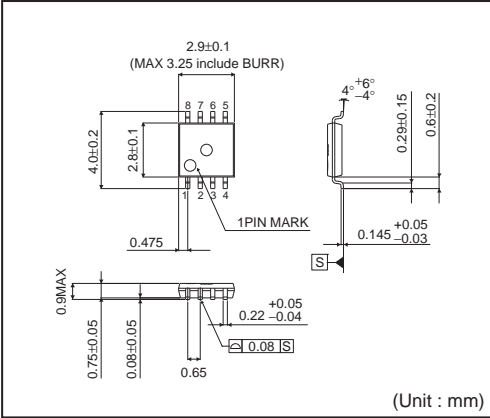

<Tape and Reel information>

Tape	Embossed carrier tape
Quantity	3000pcs
Direction of feed	TR (The direction is the 1pin of product is at the upper right when you hold reel on the left hand and you pull out the tape on the right hand)

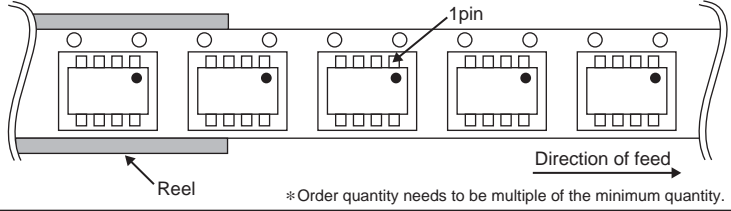

Notes

No copying or reproduction of this document, in part or in whole, is permitted without the consent of ROHM Co.,Ltd.

The content specified herein is subject to change for improvement without notice.

The content specified herein is for the purpose of introducing ROHM's products (hereinafter "Products"). If you wish to use any such Product, please be sure to refer to the specifications, which can be obtained from ROHM upon request.

Examples of application circuits, circuit constants and any other information contained herein illustrate the standard usage and operations of the Products. The peripheral conditions must be taken into account when designing circuits for mass production.

Great care was taken in ensuring the accuracy of the information specified in this document. However, should you incur any damage arising from any inaccuracy or misprint of such information, ROHM shall bear no responsibility for such damage.

The technical information specified herein is intended only to show the typical functions of and examples of application circuits for the Products. ROHM does not grant you, explicitly or implicitly, any license to use or exercise intellectual property or other rights held by ROHM and other parties. ROHM shall bear no responsibility whatsoever for any dispute arising from the use of such technical information.

The Products specified in this document are intended to be used with general-use electronic equipment or devices (such as audio visual equipment, office-automation equipment, communication devices, electronic appliances and amusement devices).

The Products specified in this document are not designed to be radiation tolerant.

While ROHM always makes efforts to enhance the quality and reliability of its Products, a Product may fail or malfunction for a variety of reasons.

Please be sure to implement in your equipment using the Products safety measures to guard against the possibility of physical injury, fire or any other damage caused in the event of the failure of any Product, such as derating, redundancy, fire control and fail-safe designs. ROHM shall bear no responsibility whatsoever for your use of any Product outside of the prescribed scope or not in accordance with the instruction manual.

The Products are not designed or manufactured to be used with any equipment, device or system which requires an extremely high level of reliability the failure or malfunction of which may result in a direct threat to human life or create a risk of human injury (such as a medical instrument, transportation equipment, aerospace machinery, nuclear-reactor controller, fuel-controller or other safety device). ROHM shall bear no responsibility in any way for use of any of the Products for the above special purposes. If a Product is intended to be used for any such special purpose, please contact a ROHM sales representative before purchasing.

If you intend to export or ship overseas any Product or technology specified herein that may be controlled under the Foreign Exchange and the Foreign Trade Law, you will be required to obtain a license or permit under the Law.



Thank you for your accessing to ROHM product informations.
More detail product informations and catalogs are available, please contact us.

ROHM Customer Support System

<http://www.rohm.com/contact/>