

Optoisolators

QUICK REFERENCE CHART

OUTPUT FORMAT	PRODUCT	PACKAGE KEY	PACKAGE TYPE	MIN. CURRENT TRANSFER RATIO	MIN. DC ISOLATION VOLTAGE	MIN. OUTPUT VOLTAGE RATING (V _{CEO})	TYPICAL BANDWIDTH R _L = 100Ω
TRANSISTOR	MCT2	A	6 LEAD PLASTIC DIP	20%	1500 V	30 V	150 kHz
TRANSISTOR	MCT2E	A	6 LEAD PLASTIC DIP	20%	2500 V	30 V	150 kHz
TRANSISTOR	MCT210	A	6 LEAD PLASTIC DIP	150%	4000 V	30 V	150 kHz
TRANSISTOR	MCT26	A	6 LEAD PLASTIC DIP	6%	1500 V	30 V	150 kHz
TRANSISTOR	MCT4	C	TO-46 METAL CAN	15%	1000 V	30 V	150 kHz
TRANSISTOR	MCT4R*	C	TO-46 METAL CAN	15%	1000 V	30 V	150 kHz
TRANSISTOR	MCT6	B	8 LEAD PLASTIC DIP	20%	1500 V	30 V	150 kHz
TRANSISTOR	MCT66	B	8 LEAD PLASTIC DIP DUAL CHANNEL	6%	1500 V	30 V	150 kHz
TRANSISTOR	4N25	F	6 LEAD PLASTIC DIP	20%	2500 V	30 V	300 kHz
TRANSISTOR	4N26	F	6 LEAD PLASTIC DIP	20%	1500 V	30 V	300 kHz
TRANSISTOR	4N27	F	6 LEAD PLASTIC DIP	10%	1500 V	30 V	300 kHz
TRANSISTOR	4N28	F	6 LEAD PLASTIC DIP	10%	500 V	30 V	300 kHz
TRANSISTOR	4N35	F	6 LEAD PLASTIC DIP	100%	3550 V	30 V	150 kHz
TRANSISTOR	4N36	F	6 LEAD PLASTIC DIP	100%	2500 V	30 V	150 kHz
TRANSISTOR	4N37	F	6 LEAD PLASTIC DIP	100%	1500 V	30 V	150 kHz
DARLINGTON TRANS.	MCA230	A	6 LEAD PLASTIC DIP	100%	1500 V	30 V	10 kHz
DARLINGTON TRANS.	MCA231	A	6 LEAD PLASTIC DIP	200%	1500 V	30 V	10 kHz
DARLINGTON TRANS.	MCA255	A	6 LEAD PLASTIC DIP	100%	1500 V	55 V	10 kHz
DARLINGTON TRANS.	4N29	F	6 LEAD PLASTIC DIP	100%	2500 V	30 V	30 kHz
DARLINGTON TRANS.	4N30	F	6 LEAD PLASTIC DIP	100%	1500 V	30 V	30 kHz
DARLINGTON TRANS.	4N31	F	6 LEAD PLASTIC DIP	50%	1500 V	30 V	30 kHz
DARLINGTON TRANS.	4N32	F	6 LEAD PLASTIC DIP	500%	2500 V	30 V	30 kHz
DARLINGTON TRANS.	4N33	F	6 LEAD PLASTIC DIP	500%	1500 V	30 V	30 kHz

*Reliability conditioned to MIL-STD-883, Method 5005/B, 100% pre-conditioning.

OUTPUT FORMAT	PRODUCT	PACKAGE KEY	PACKAGE TYPE	DC ISOLATION VOLTAGE	FORWARD BLOCKING VOLTAGE (V _{DRRM})	MAX. TURN-ON CURRENT (I _F)
SCR	MCS2	A	6 LEAD PLASTIC DIP	1500 V	200 V	14.0 mA
SCR	MCS2400	A	6 LEAD PLASTIC DIP	1500 V	400 V	14.0 mA
2 SCR's (CONNECTED ANODE TO CATHODE)	MCS6200	B	8 LEAD PLASTIC DIP	1500 V	200 V	14.0 mA
2 SCR's (CONNECTED ANODE TO CATHODE)	MCS6201	B	8 LEAD PLASTIC DIP	2500 V	200 V	14.0 mA

OUTPUT FORMAT	PRODUCT	PACKAGE KEY	PACKAGE TYPE	MIN. DC ISOLATION VOLTAGE	MIN. BINARY DATA RATE (BDR)	MAX. TRIGGER (I _F)	TYP. HYSTERESIS (ΔI _F)
LOGIC GATE OPEN COLLECTOR	MCL601	B	8 LEAD PLASTIC DIP	2000 V	0.10 MHz	5.0 mA	1.0 mA
LOGIC GATE OPEN COLLECTOR	MCL611	B	8 LEAD PLASTIC DIP	2000 V	1.0 MHz	15.0 mA	5.0 mA

(TOTEM POLE OUTPUT - MCL600 & MCL610 available February, 1977.)

OUTPUT FORMAT	PRODUCT	PACKAGE KEY	PACKAGE TYPE	COLLECTOR CURRENT (I _C)	TYPICAL BANDWIDTH	MAX. DARK CURRENT (I _{CEO})
TRANSISTOR	MCT8	E	SLOTTED LIMIT SWITCH	200 μA @ I _F = 20 mA, V _{CE} = 10 V	150 kHz	100 nA
TRANSISTOR	MCT81	E	SLOTTED LIMIT SWITCH	50 μA @ I _F = 20 mA, V _{CE} = 10 V	200 kHz	100 nA
DARLINGTON	MCA7	D	REFLECTIVE SENSOR SWITCH	50 μA @ I _F = 50 mA, V _{CE} = 5 V	0.8 kHz	100 nA
DARLINGTON	MCA8	E	SLOTTED LIMIT SWITCH	2 mA @ I _F = 16 mA, V _{CE} = 1 V	0.8 kHz	100 nA
DARLINGTON	MCA81	E	SLOTTED LIMIT SWITCH	1.6 mA @ I _F = 50 mA, V _{CE} = 1 V	1.5 kHz	100 nA

Monsanto

OPTICALLY ISOLATED LOGIC GATE

MCL601 MCL611

PRODUCT DESCRIPTION

The MCL601 and MCL611, are optically isolated logic gates in an 8-lead DIP package. A GaAs LED radiates infrared light onto a high speed photodiode detector, thus providing electrical isolation of ± 2000 V between input and output. A differential comparator amplifies the photodiode signal, and a Schmitt trigger improves noise immunity by providing threshold and hysteresis. A standard open collector circuit on the output offers normal current sinking capability. The LED drive current requirement matches either mode of logic loading. The output is compatible to most logic systems. The MCL601 has a 0.1 MHz data rate; the MCL 611 has a 1 MHz data rate.

PACKAGE DIMENSIONS

ALL DIMENSIONS IN INCHES

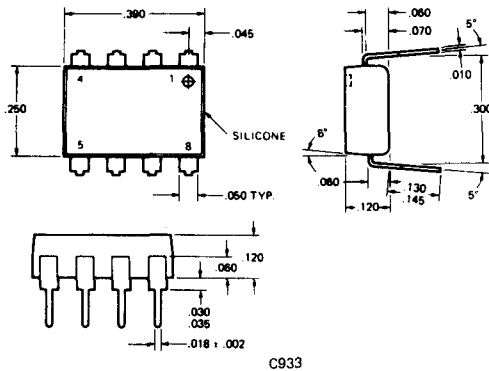

PIN	
1	LED ANODE
2	LED CATHODE
3	N/C
4	N/C
5	OUT
6	GROUND
7	V _{CC}
8	PHOTO DIODE CATHODE

FEATURES

- Compatible TTL input drive load
- Output compatible to TTL, DTL, RTL, CTL, HiNIL
- Single +5 V_{CC} supply required
- High toggle speed, high data rate
- Short transmission delay
- Small 8 pin DIP, two packages fit 16 pin socket
- High isolation between input-output
- High CMRR (Common Mode Rejection Ratio)
- Built-in hysteresis for noise immunity
- Output ORing capability

APPLICATIONS

- Digital logic to digital logic isolator—eliminates spurious grounds
- DC input level sensor—Schmitt trigger toggle
- AC to TTL conversion—square wave shaping
- Line receiver—eliminates CMN and ground loop transients
- Logic level shifter, input-output independent ground systems

SCHEMATIC DIAGRAM

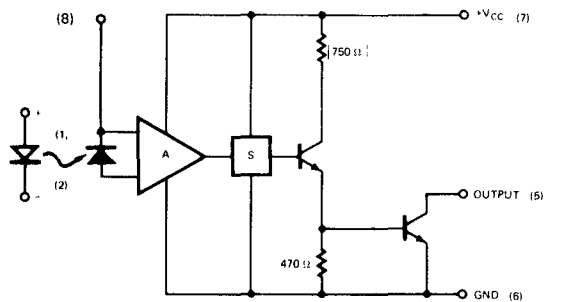

A = Differential amp, comparator
S = Schmitt trigger, threshold hysteresis
Typical Values Shown

SYMBOL

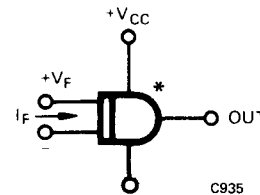

* OPEN COLLECTOR

ABSOLUTE MAXIMUM RATINGS

Storage temperature	-55°C to +150°C
Operating temperature	0°C to +70°C
Lead temperature (Soldering, 10 sec.)	260°C
Input Diode	
Forward DC current	20 mA
Reverse Voltage	3V
Peak forward current (1 μs pulse, 300 pps)	3.0 A
Power dissipation at 25°C ambient	100 mW
Derate linearly from 25°C	1.33 mW/°C
Output Gate	
Power dissipation at 25°C ambient	100 mW
Derate linearly from 25°C	1.33 mW/°C
DC supply current I _{CC}	30 mA
Output collector voltage V _{SS}	15V
V _{CC}	8V
Output current low - I _{OL}	16 mA
Input to output voltage	±2000 V DC

Note: The input is not specified as "HI" or "LOW" as with normal gate units. The input is "ON" or "OFF," set by the current flow through the input LED. Thus the input may be "ON" for logic drive "HI" (pull up load system, Figure 1A) or logic drive "LOW" (pull down load systems, Figure 1B, as in open collector output devices.) See Z plot.

As a convenience of notation, reference will be made to a pull down type load input connected as in Figure 1B. A logical "LOW" is "ON", and a logical "HI" is "OFF".

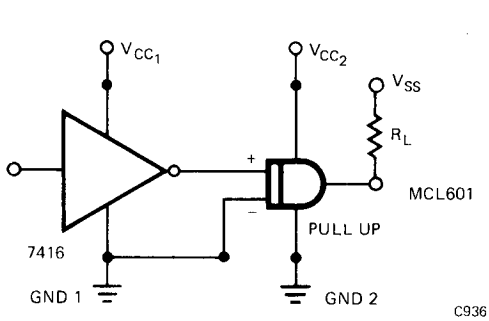

Figure 1A

C936

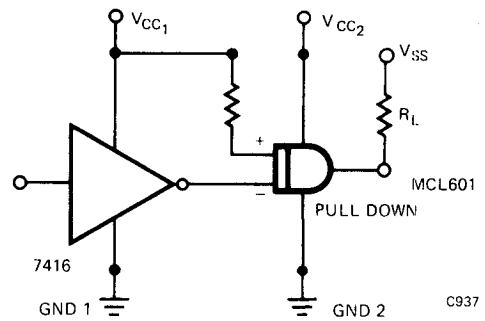

Figure 1B

C937

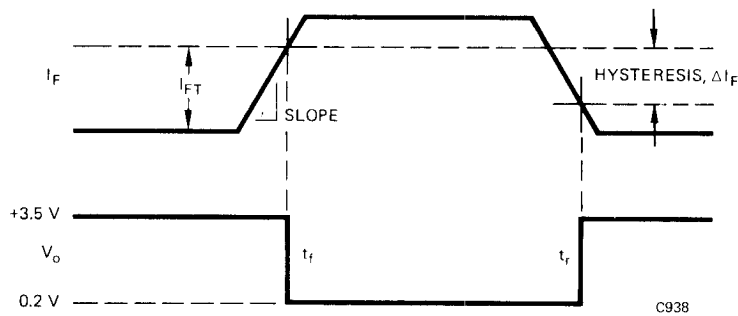

Figure 2A

C938

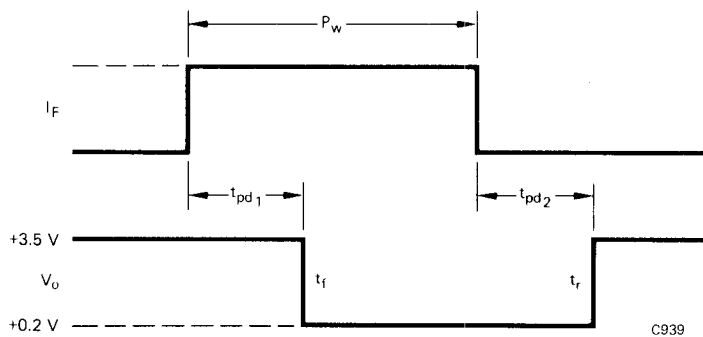

Figure 2B

C939

The MCL input may be driven in series or in parallel with other MCL units, and/or in parallel with other logic units. The input of the MCL has an equivalent unit load (U.L.) rating related to current requirements.

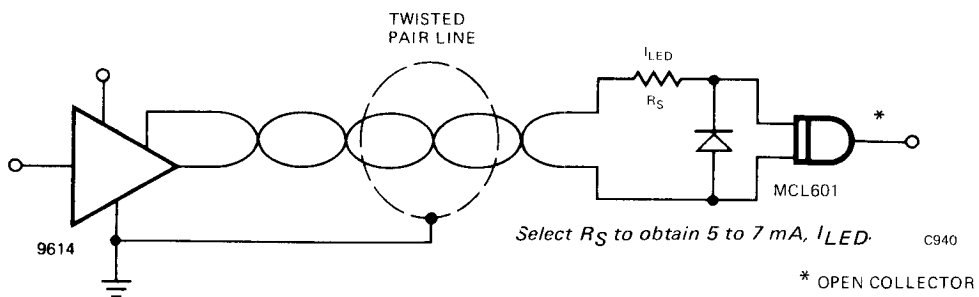

Fig. 3. Line Receiver

C940

* OPEN COLLECTOR

RECOMMENDED OPERATING CONDITIONS

PARAMETER	LIMITS			UNITS
	MIN.	TYP.	MAX.	
Supply Voltage V_{CC}	4.5	5.0	5.5	Volts
Operating Free Air Temperature Range	0	25	70	$^{\circ}C$
Normalized Fan Out			20	U.L.
Logic HIGH			20	U.L.
Logic LOW			10	U.L.
Maximum Input Rise and Fall Time	Slope	{ No Restriction { See Fig. 2A least t_{pd}		
Minimum Input Rise and Fall Time				
Minimum Pulse Width				

ELECTRICAL CHARACTERISTICS (25 $^{\circ}C$)

PARAMETER	SYMBOL	LIMITS			UNITS	TEST CONDITIONS (Note 1)
		MIN.	TYP. (Note 2)	MAX.		
Input Diode						
Forward Voltage	V_F		1.25	1.50	V	$I_F = 20\text{ mA}$
Forward Voltage Temp Coefficient			-1.8		$mV/^{\circ}C$	
Reverse Breakdown Voltage	BV_R	3.0	5.5		V	$I_R = 10\ \mu A$
Reverse Leakage Current			.001	10	μA	$V_R = 3.0\text{ V}$
Junction Capacitance	C_J		50		pF	$V_F = 0$
Rise Time	t_r		20		ns	$I_F = 50\text{ mA}, 50\Omega\text{ system}$
Fall Time	t_f		20		ns	$I_F = 50\text{ mA}, 50\Omega\text{ system}$
Output						
Output Current HIGH (collector leakage)	I_{OHL}			200	μA	$V_{CC} = 4.5\text{ V}, I_F = 0\text{ mA}$ $V_{OH} = 15\text{ V}$
Output Voltage LOW	V_{OL}		0.2	0.4	Volts	$V_{CC} = 4.5\text{ V}, I_F = (\text{ON})\text{MAX}$ $I_{OL} = 16\text{ mA}$
Supply Current HIGH	I_{CCH}		6	15	mA	$V_{CC} = 5.5\text{ V}, I_F = 0\text{ mA}$
Supply Current LOW	I_{CCL}		10	25	mA	$V_{CC} = 5.5\text{ V}, I_F = \text{MAX}$

MCL601, 5 mA DRIVE ($V_{CC} = 5\text{ V}$)

Switching Characteristics (Fig. 2B)

t_{pd} (On)		2	4	μs	$I_F = 3.0\text{ mA}$
t_{pd} (Off)		2	4	μs	$I_F = 3.0\text{ mA}$
t_r, t_f			10	ns	$C_L = 25\text{ pF}, R_L = 280\Omega$
Binary data rate		0.1	0.2	MHz	$I_F = 3.0\text{ mA}, R_L = 280\ \Omega$

Input Diode

I_F (On)		3.0	5.0	mA	
I_F (Off)		0.5	2.0	mA	
ΔI_F (hysteresis)			1.0	mA	
V_F (On)			1.15	V	$I_F = 5.0\text{ mA}$
V_F (Off)			0.95	V	$I_F = 1.0\text{ mA}$
Input load equivalent			2	U.L.	

MCL611, 15 mA DRIVE ($V_{CC} = 5\text{ V}$)

Switching Characteristics (Fig. 2B)

t_{pd} (On) (Fig. 9)		.3	.6	μs	$I_F = 10\text{ mA}$
t_{pd} (Off)				μs	$I_F = 10\text{ mA}$
t_r, t_f			10	ns	$C_L = 25\text{ pF}, R_L = 280\Omega$
Binary data rate		1.0	1.2	MHz	$I_F = 3.0\text{ mA}, R_L = 280\ \Omega$

Input Diode (Fig. 11)

I_F (On)		10	15	mA	
I_F (Off)		2.0	5	mA	
ΔI_F (hysteresis)			5	mA	
V_F (On)			1.1	V	$I_F = 10\text{ mA}$
V_F (Off)		1.00	1.1	V	$I_F = 2.5\text{ mA}$
Input load equivalent			6	U.L.	

ISOLATION

DC Voltage Breakdown	2000		VDC
AC Voltage Limit @ 60 Hz	800		VRMS
Capacitance		1.0	pF
Resistance		10^{12}	Ω

TYPICAL ELECTRO-OPTICAL CHARACTERISTIC CURVES

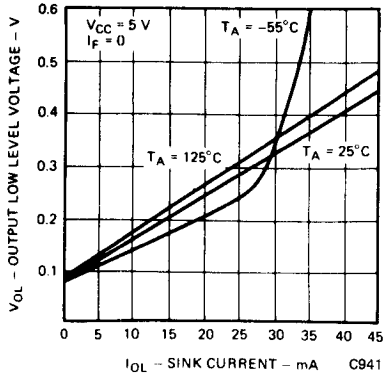

Fig. 4. Low Level Output Voltage vs. Sink Current

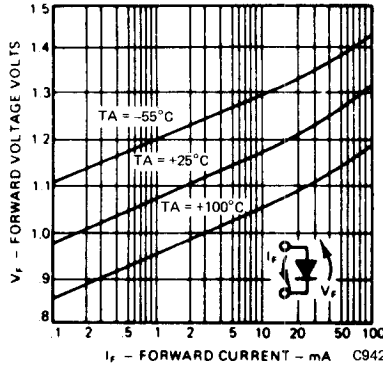

Fig. 5. Forward Voltage vs. Forward Current

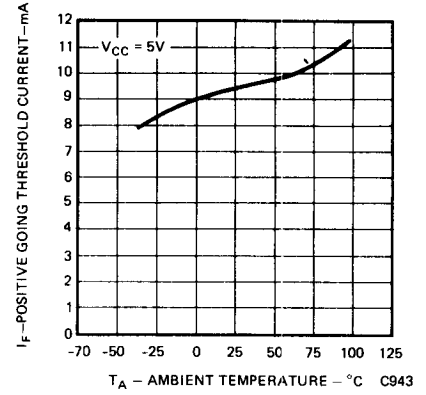

Fig. 6. MCL 611-Positive Going Threshold Current vs. Ambient Temperature

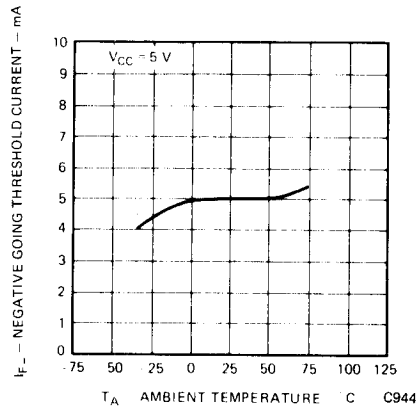

Fig. 7. MCL611-Negative-Going Threshold Current vs. Ambient Temperature

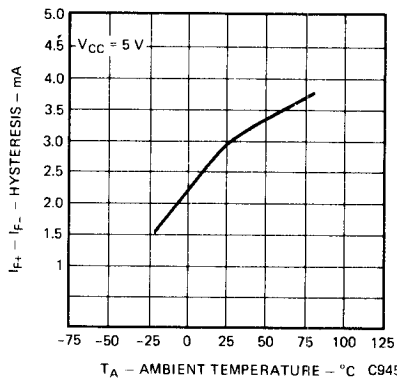

Fig. 8. MCL611-Hysteresis vs. Ambient Temperature

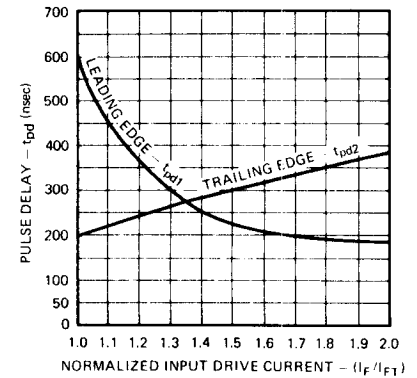

Fig. 9. MCL611-Normalized Input Drive Current vs. Pulse Delay

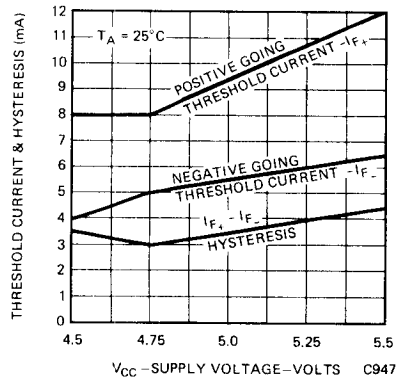

Fig. 10. MCL611-Threshold Current & Hysteresis vs. Supply Voltage

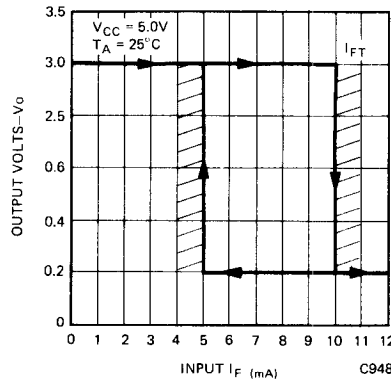

Fig. 11. MCL611-Threshold & Hysteresis of Input/Output

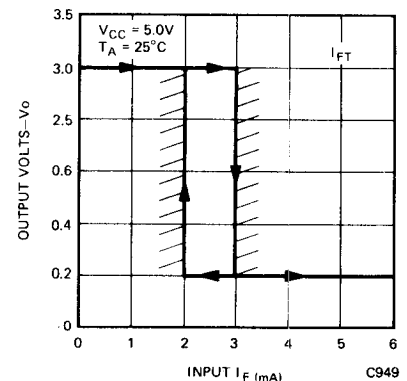

Fig. 12. MCL601-Threshold & Hysteresis of Input/Output

NOTES:

1. For conditions shown as MIN. or MAX., use the appropriate value specified under recommended operating conditions for the applicable device type.
2. Typical limits are at VCC = 5.0 V, 25°C.