

PLEASE CHECK WWW.MOLEX.COM FOR LATEST PART INFORMATION

Part Number: [0334810202](#)
Status: **Active**
Overview: [mx150 sealed connector system](#)
Description: 3.50mm (.138") Pitch MX150™ Sealed Male Connector, Single Row, 2 Circuits, Polarization B, without Connector Position Assurance, Light Gray

Documents:

[Drawing \(PDF\)](#) [RoHS Certificate of Compliance \(PDF\)](#)

General

Product Family	Crimp Housings
Series	33481
Comments	No Connector Position Assurance (CPA)
More Detailed Tech Information	http://ewcap.uscarteams.org
Overview	mx150 sealed connector system
Product Name	MX150™

Physical

Circuits (maximum)	2
Circuits Detail	2
Color - Resin	Gray (Light), Natural
Gender	Male
Glow-Wire Compliant	No
Keying to Mating Part	Yes
Lock to Mating Part	Yes
Material - Resin	Modified Polystyrene Alloy
Number of Rows	1
Packaging Type	Bag
Panel Mount	No
Pitch - Mating Interface (in)	0.138 In
Pitch - Mating Interface (mm)	3.50 mm
Polarized to Mating Part	Yes
Stackable	No
Temperature Range - Operating	-40°C to +125°C

Electrical

Current - Maximum per Contact	22A
-------------------------------	-----

Material Info

Reference - Drawing Numbers

Application Specification	AS-33472-100
Packaging Specification	PK-31300-635
Sales Drawing	SD-33481-021



EU RoHS

China RoHS

Compliance Status

Not Reviewed

REACH SVHC

Contains SVHC: No

Halogen-Free

Status

Halogen-Free

Need more information on product environmental compliance?

Email productcompliance@molex.com
 For a multiple part number RoHS Certificate of Compliance, [click here](#)

Please visit the [Contact Us](#) section for any non-product compliance questions.

Search Parts in this Series

[33481Series](#)

Mates With

[33471](#) Female Single Row Sealed Connector

Use With

[33000](#) MX150™ Male Terminal

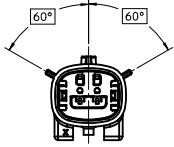

KEYING OPTION A

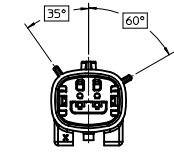

KEYING OPTION B

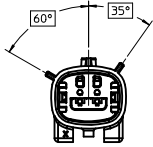

KEYING OPTION C

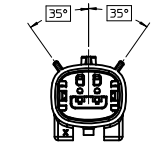

KEYING OPTION D

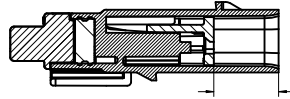

Section A-A
PLR INSERT SHOWN IN PRE - LOCK POSITION

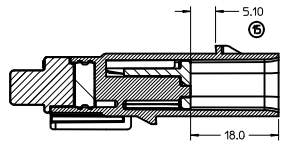

Section A-A
PLR SHOWN IN FINAL - LOCK POSITION

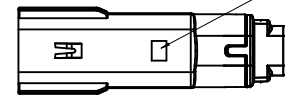
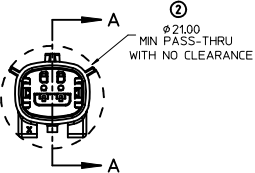
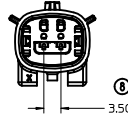

OPTIONAL TRACEABILITY
INFORMATION LOCATED
IN THIS AREA

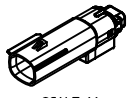
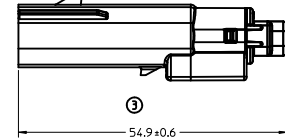

SCALE 1:1

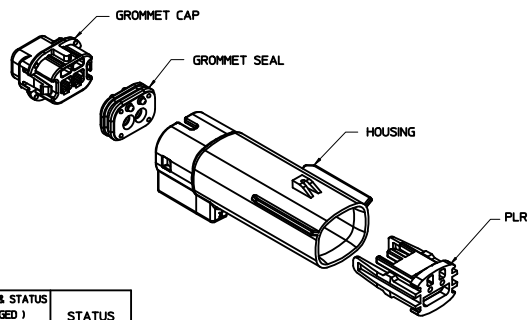
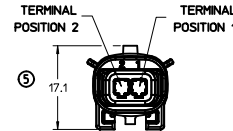

NOTES: UNLESS OTHERWISE SPECIFIED

1. GENERAL: SHALL CONFORM TO THE FOLLOWING

- a. SHALL CONFORM TO MOLEX PRODUCT SPECIFICATION: PS-33471-000
- b. PACKAGING SPECIFICATION: PK-31300-635
- c. APPLICATION SPECIFICATION: AS-33472-100
- d. FOR MATING CONNECTOR ASSEMBLIES SEE MOLEX PRODUCT SPECIFICATION: PS-33471-0002
- e. FOR APPROPRIATE TERMINALS AND WIRE SIZES TO BE USED WITH THIS ASSEMBLY SEE MOLEX PRODUCT SPECIFICATION: PS-33471-000
- f. FOR CAVITY PLUGS TO BE USED WITH THIS ASSEMBLY SEE MOLEX DRAWING: SD-34345-001
- g. FOR TERMINAL SERVICING TOOL SEE MOLEX DOCUMENT: ATS-638131500
- h. ASSEMBLY SHIPPED WITH THE PLR IN PRE-LOCK POSITION UPON FULL TERMINAL ASSEMBLY EACH PLR MUST BE SNAPPED INTO FINAL-LOCK POSITION. IN THE EVENT THE PLR IS FOUND IN THE FINAL-LOCK (SEATED) POSITION REFER TO MOLEX SPECIFICATION PS-34646-001 AVAILABLE AT WWW.MOLEX.COM

2. DESIGN MATERIAL:

- A. HOUSING: SPS/NYLON BLEND, 20% GLASS FILLED, 20 % MAX REGRIND
COLOR: SEE TABLE
- B. PLR: SPS/NYLON BLEND, 20% GLASS FILLED, 20 % MAX REGRIND
COLOR: SEE TABLE
- C. GROMMET CAP: SPS/NYLON BLEND, 20% GLASS FILLED, 20 % MAX REGRIND
COLOR: SEE TABLE
- D. GROMMET SEAL: INHERENTLY LUBRICATED SILICONE, 30 DUROMETER
COLOR: SEE TABLE

MOLEX ASM NUMBERS	KEYING OPTION	CAVITY TYPE & STATUS (X = PLUGGED)		STATUS
		1	2	
33481-0201	A			OK TO TOOL
33481-0202	B			OK TO TOOL
33481-0203	C			OK TO TOOL
33481-0204	D			OK TO TOOL
33481-0205	A	X	X	OK TO TOOL
33481-0206	B	X	X	OK TO TOOL
33481-0207	C	X	X	OK TO TOOL
33481-0208	D	X	X	OK TO TOOL

DESCRIPTION	COLOR	NO. OF ITEMS REQUIRED
HOUSING - KEYING OPTION A	BLACK	1
HOUSING - KEYING OPTION B	LIGHT GRAY	1
HOUSING - KEYING OPTION C	DARK GRAY	1
HOUSING - KEYING OPTION D	STONE GRAY	1
PLR	NATURAL	1 1 1 1 1 1 1 1
GROMMET CAP (OPEN)	BLACK	1 1 1 1 1 1 1 1
GROMMET CAP (PLUGGED)	BLACK	1 1 1 1 1 1 1 1
GROMMET SEAL	RUST RED	1 1 1 1 1 1 1 1

ENTER DESCRIPTION IEC NO. UAU2010-1561 DRAWN: M.VANSLAMBRO 2009/10/27 CHK'D: S.VERZYL 9/16/08 APPR: VKOSHY 2010/03/18	QUALITY SYMBOLS =0 =0	GENERAL TOLERANCES (UNLESS SPECIFIED) 4 PLACES ± mm ± INCH 3 PLACES ± --- ± --- 2 PLACES ± 0.10 ± --- 1 PLACE ± 0.20 ± --- ANGULAR ± 3 °		DIMENSION STYLE MM ONLY		SCALE 2:1 DESIGN UNITS METRIC THIRD ANGLE PROJECTION
		DRAWN BY M. VANSLAMBRO DATE 9/16/08 CHECKED BY S. VERZYL DATE 9/16/08 APPROVED BY VKOSHY DATE 2010/03/18		TITLE MX150 1X2 SEALED BLADE ASSEMBLY, 1X2		
		MATERIAL NO. SEE TABLE DRAFT WHERE APPLICABLE MUST REMAIN WITHIN DIMENSIONS		MOLEX INCORPORATED DOCUMENT NO. SD-33481-021		
		SIZE D THIS DRAWING CONTAINS INFORMATION THAT IS PROPRIETARY TO MOLEX INCORPORATED AND SHOULD NOT BE USED WITHOUT WRITTEN PERMISSION		SHEET NO. 1 OF 1		