



TO-220



TO-251 (IPAK)



TO-252 (DPAK)



Pin Definition:

1. Gate
2. Drain
3. Source

PRODUCT SUMMARY

V_{DS} (V)	$R_{DS(on)}$ (Ω)	I_D (A)
600	5 @ $V_{GS}=10V$	1

General Description

The TSM2N60 is used an advanced termination scheme to provide enhanced voltage-blocking capability without degrading performance over time. In addition, this advanced MOSFET is designed to withstand high energy in avalanche and commutation modes. The new energy efficient design also offers a drain- to-source diode with a fast recovery time. Designed for high voltage, high speed switching applications in power supplies, converters and PWM motor controls, these devices are particularly well suited for bridge circuits where diode speed and commutating safe operating areas are critical and offer additional and safety margin against unexpected voltage transients.

Features

- Robust high voltage termination
- Avalanche energy specified
- Diode is characterized for use in bridge circuits
- Source to Drain diode recovery time comparable to a discrete fast recovery diode.

Ordering Information

Part No.	Package	Packing
TSM2N60CP RO	TO-252	2.5Kpcs/ 13" Reel
TSM2N60CH C5	TO-251	75pcs / Tube
TSM2N60CZ C0	TO-220	50pcs / Tube

Block Diagram

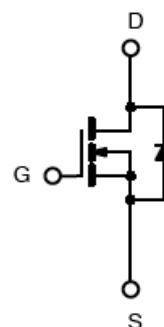

N-Channel MOSFET

Absolute Maximum Rating ($T_a = 25^\circ C$ unless otherwise noted)

Parameter	Symbol	Limit	Unit
Drain-Source Voltage	V_{DS}	600	V
Gate-Source Voltage	V_{GS}	± 30	V
Continuous Drain Current	I_D	2	A
Pulsed Drain Current	I_{DM}	9	A
Continuous Source Current (Diode Conduction) ^{a,b}	I_S	1	A
Single Pulse Drain to Source Avalanche Energy ($V_{DD} = 100V, V_{GS}=10V, I_{AS}=2A, L=10mH, R_G=25\Omega$)	EAS	20	mJ
Maximum Power Dissipation @ $T_c = 25^\circ C$	TO-251 / TO-252	70	W
	TO-220	70	
Operating Junction Temperature	T_J	+150	$^\circ C$
Operating Junction and Storage Temperature Range	T_J, T_{STG}	-55 to +150	$^\circ C$

Thermal Performance

Parameter		Symbol	Limit	Unit
Thermal Resistance - Junction to Case	TO-251 / TO-252	$R_{\theta JC}$	2.87	°C/W
	TO-220		2.32	
Thermal Resistance - Junction to Ambient	TO-251 / TO-252	$R_{\theta JA}$	110	°C/W
	TO-220		62.5	

Notes: Surface mounted on FR4 board $t \leq 10\text{sec}$

Electrical Specifications (Ta = 25°C unless otherwise noted)

Parameter	Conditions	Symbol	Min	Typ	Max	Unit
Static						
Drain-Source Breakdown Voltage	$V_{GS} = 0V, I_D = 250\mu A$	BV_{DSS}	600	--	--	V
Drain-Source On-State Resistance	$V_{GS} = 10V, I_D = 1A$	$R_{DS(ON)}$	--	4.4	5	Ω
Gate Threshold Voltage	$V_{DS} = V_{GS}, I_D = 250\mu A$	$V_{GS(TH)}$	2.0	--	4.0	V
Zero Gate Voltage Drain Current	$V_{DS} = 600V, V_{GS} = 0V$	I_{DSS}	--	--	10	μA
Gate Body Leakage	$V_{GS} = \pm 20V, V_{DS} = 0V$	I_{GSS}	--	--	± 100	nA
Forward Transconductance	$V_{DS} = 40V, I_D = 1A$	g_{fs}	--	5	--	S
Diode Forward Voltage	$I_S = 2A, V_{GS} = 0V$	V_{SD}	--	--	1.6	V
Dynamic^b						
Total Gate Charge	$V_{DS} = 400V, I_D = 2A, V_{GS} = 10V$	Q_g	--	13	22	nC
Gate-Source Charge		Q_{gs}	--	2	--	
Gate-Drain Charge		Q_{gd}	--	6	--	
Input Capacitance	$V_{DS} = 25V, V_{GS} = 0V, f = 1.0\text{MHz}$	C_{iss}	--	435	--	pF
Output Capacitance		C_{oss}	--	56	--	
Reverse Transfer Capacitance		C_{rss}	--	9.2	--	
Switching^c						
Turn-On Delay Time	$V_{GS} = 10V, I_D = 2A, V_{DD} = 300V, R_G = 18\Omega$	$t_{d(on)}$	--	12	--	ns
Turn-On Rise Time		t_r	--	21	--	
Turn-Off Delay Time		$t_{d(off)}$	--	30	--	
Turn-Off Fall Time		t_f	--	24	--	

Notes:

- Pulse test: pulse width $\leq 300\mu s$, duty cycle $\leq 2\%$
- For design reference only, not subject to production testing.
- Switching time is essentially independent of operating temperature.

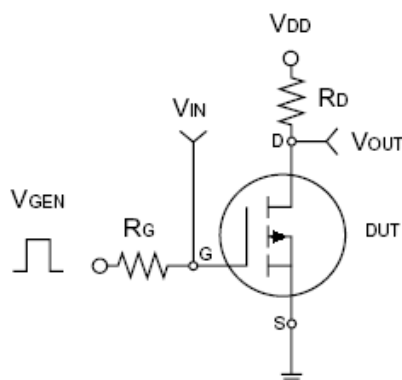

Switching Test Circuit

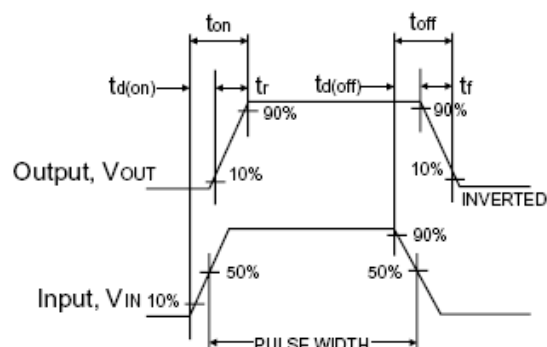

Switchin Waveforms

Electrical Characteristics Curve ($T_a = 25^\circ\text{C}$, unless otherwise noted)

Output Characteristics

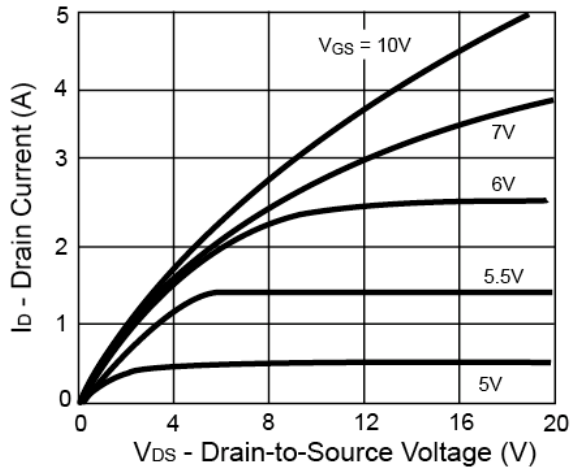

Transfer Characteristics

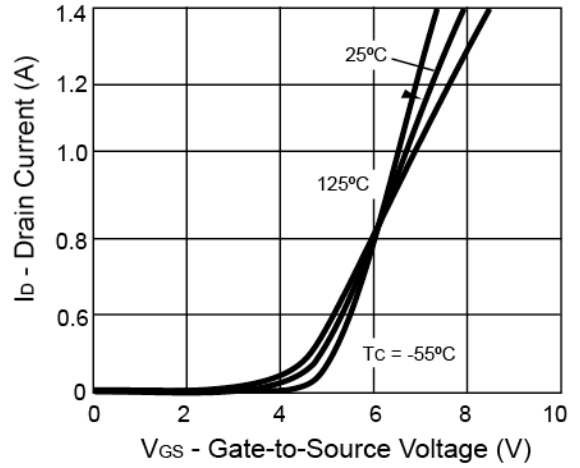

On-Resistance vs. Drain Current

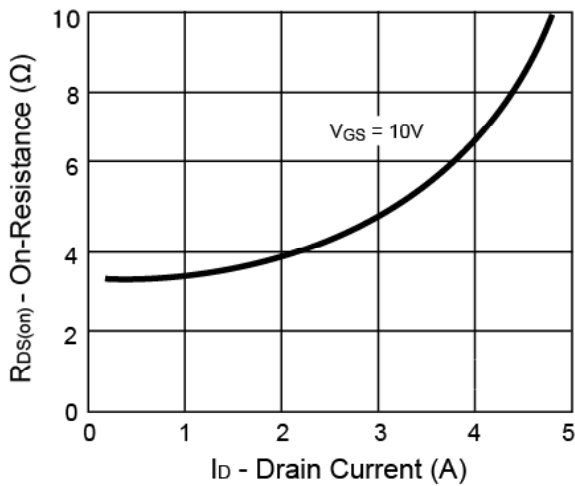

Gate Charge

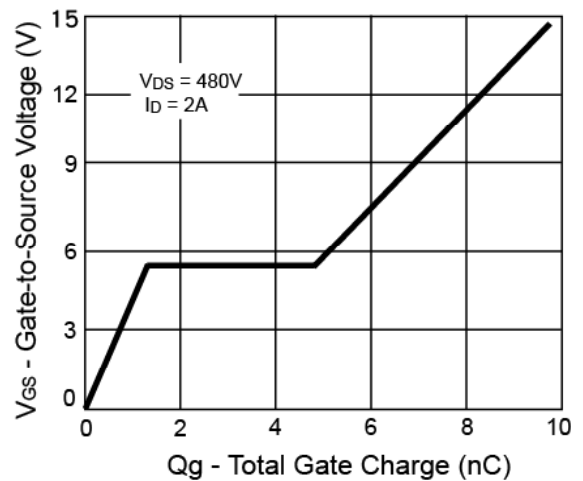

On-Resistance vs. Junction Temperature

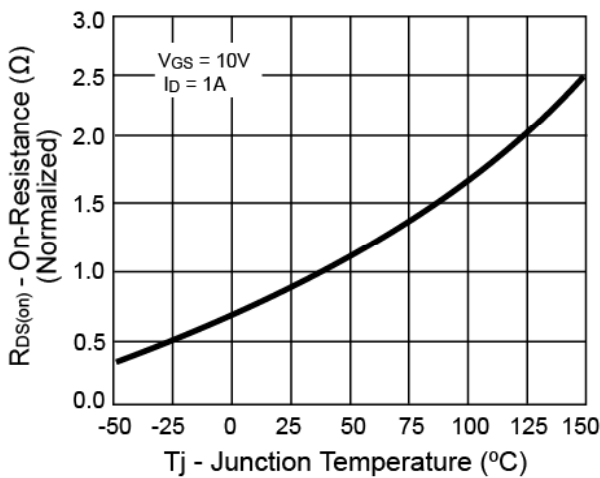

Source-Drain Diode Forward Voltage

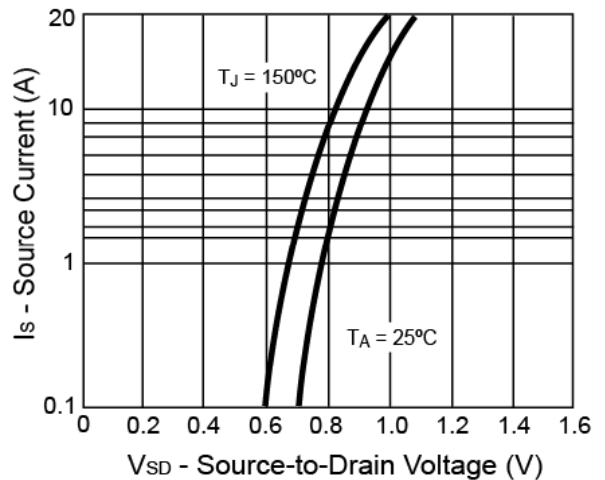



Electrical Characteristics Curve ($T_a = 25^\circ\text{C}$, unless otherwise noted)

On-Resistance vs. Gate-Source Voltage

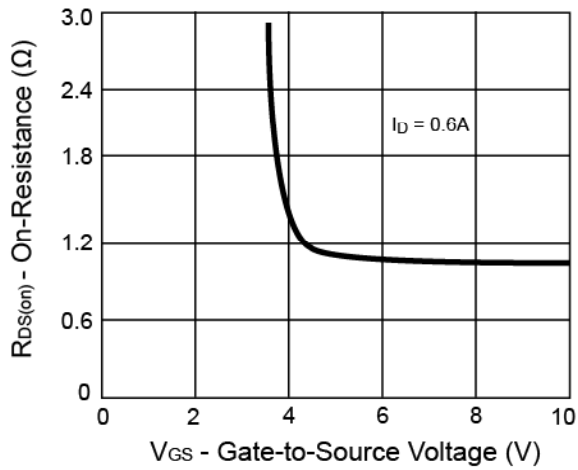

Threshold Voltage

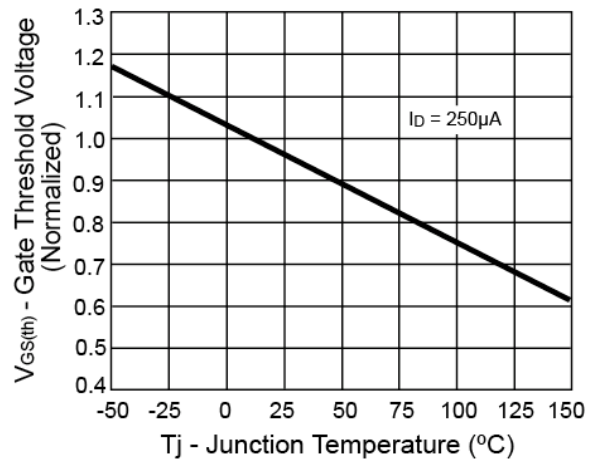

Maximum Safe Operating Area

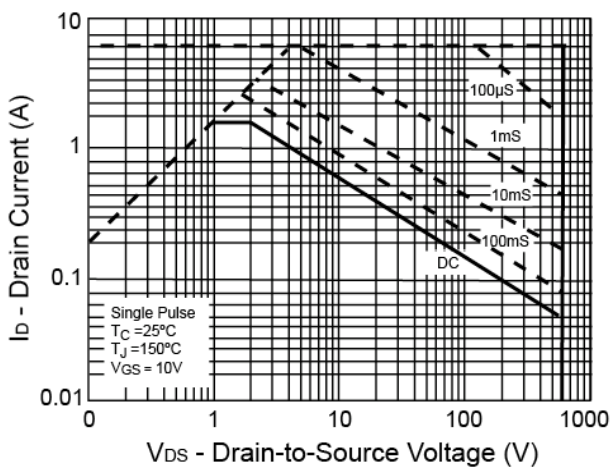

Normalized Thermal Transient Impedance, Junction-to-Ambient

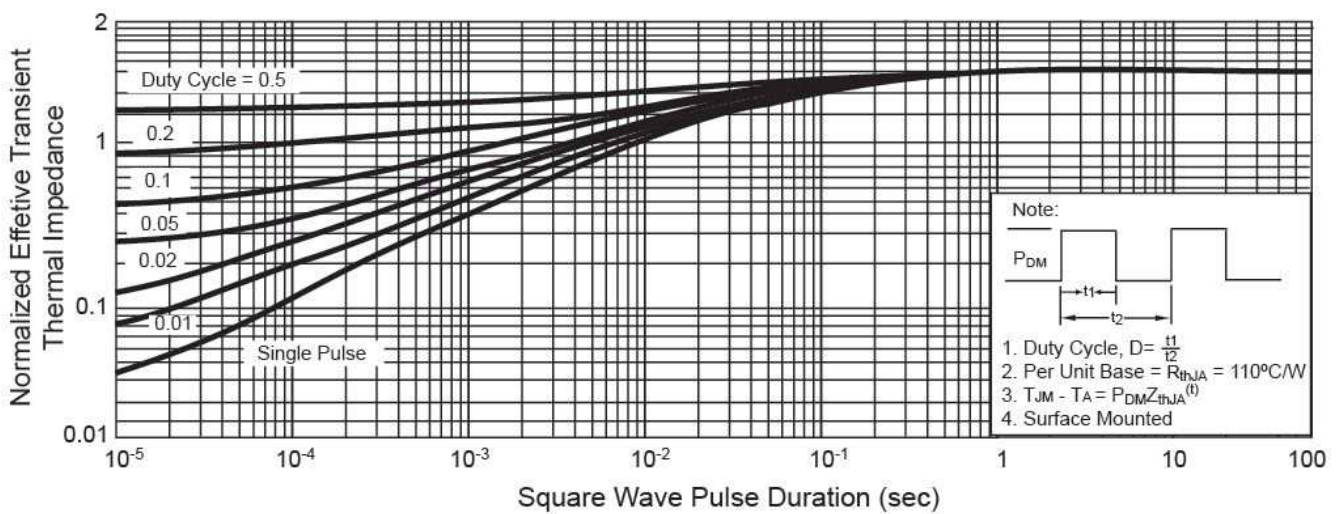

TO-220 Mechanical Drawing

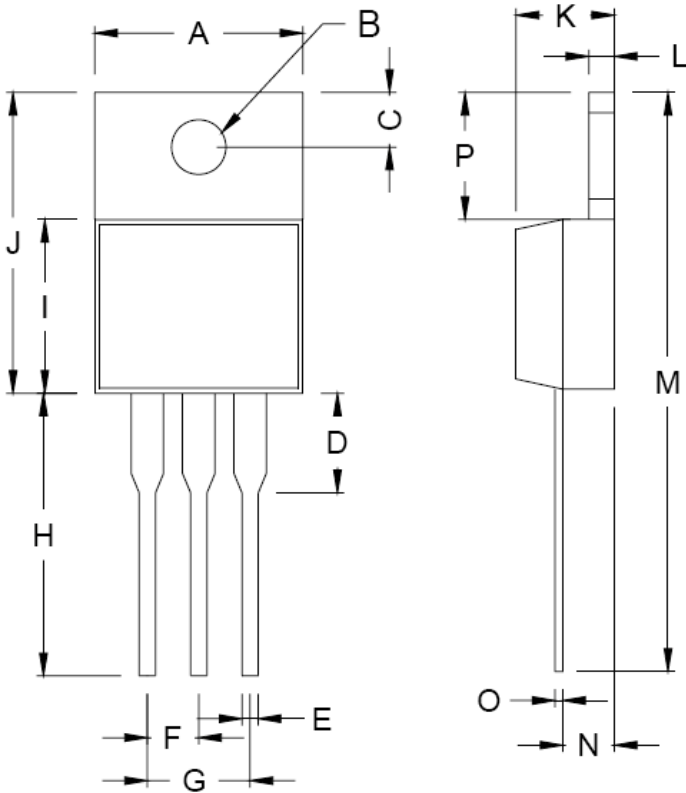

DIM	TO-220 DIMENSION			
	MILLIMETERS		INCHES	
	MIN	MAX	MIN	MAX
A	10.000	10.500	0.394	0.413
B	3.740	3.910	0.147	0.154
C	2.440	2.940	0.096	0.116
D	-	6.350	-	0.250
E	0.381	1.106	0.015	0.040
F	2.345	2.715	0.092	0.058
G	4.690	5.430	0.092	0.107
H	12.700	14.732	0.500	0.581
J	14.224	16.510	0.560	0.650
K	3.556	4.826	0.140	0.190
L	0.508	1.397	0.020	0.055
M	27.700	29.620	1.060	1.230
N	2.032	2.921	0.080	0.115
O	0.255	0.610	0.010	0.024
P	5.842	6.858	0.230	0.270

Marking Diagram

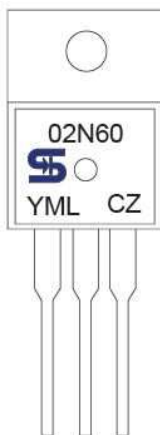

- Y** = Year Code
- M** = Month Code
(A=Jan, B=Feb, C=Mar, D=Apl, E=May, F=Jun, G=Jul, H=Aug, I=Sep, J=Oct, K=Nov, L=Dec)
- L** = Lot Code

TO-251 Mechanical Drawing

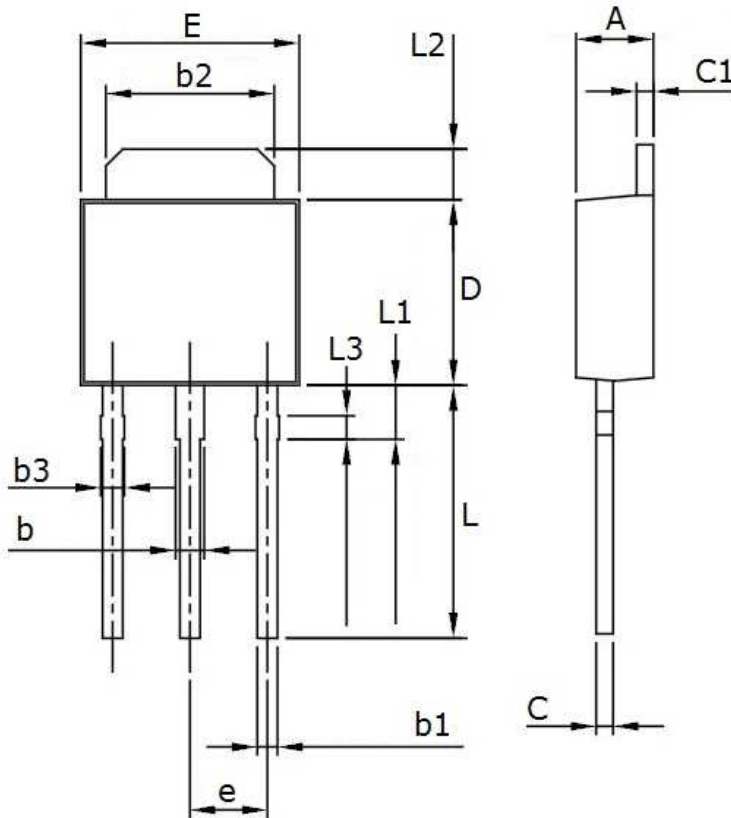

TO-251 DIMENSION				
DIM	MILLIMETERS		INCHES	
	MIN	MAX	MIN	MAX
A	2.10	2.50	0.083	0.098
b	0.65	1.05	0.026	0.041
b1	0.58	0.62	0.023	0.024
b2	4.80	5.20	0.189	0.205
b3	0.68	0.72	0.027	0.028
C	0.35	0.65	0.014	0.026
C1	0.40	0.60	0.016	0.024
D	5.30	5.70	0.209	0.224
E	6.30	6.70	0.248	0.264
e	2.30 BSC		0.09 BSC	
L	7.00	8.00	0.276	0.315
L1	1.40	1.80	0.055	0.071
L2	1.30	1.70	0.051	0.067
L3	0.50	0.90	0.020	0.035

Marking Diagram

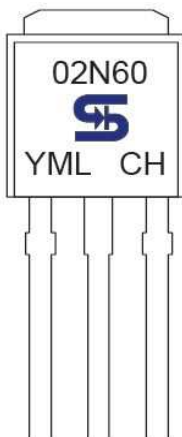

- Y** = Year Code
- M** = Month Code
(**A**=Jan, **B**=Feb, **C**=Mar, **D**=Apr, **E**=May, **F**=Jun, **G**=Jul, **H**=Aug, **I**=Sep, **J**=Oct, **K**=Nov, **L**=Dec)
- L** = Lot Code

TO-252 Mechanical Drawing

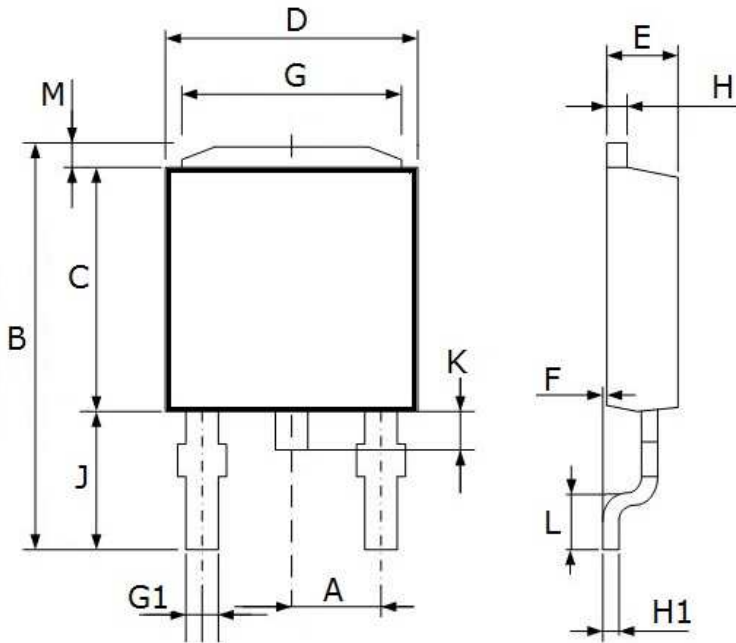

TO-252 DIMENSION				
DIM	MILLIMETERS		INCHES	
	MIN	MAX	MIN	MAX
A	2.30 BSC		0.090 BSC	
B	10.20	10.80	0.402	0.425
C	5.30	5.70	0.209	0.224
D	6.30	6.70	0.248	0.264
E	2.10	2.50	0.083	0.098
F	0.00	0.20	0.000	0.008
G	4.80	5.20	0.189	0.205
G1	0.40	0.80	0.016	0.031
H	0.40	0.60	0.016	0.024
H1	0.35	0.65	0.014	0.026
J	3.35	3.65	0.132	0.144
K	0.50	1.10	0.020	0.043
L	0.90	1.50	0.035	0.059
M	1.30	1.70	0.051	0.067

Marking Diagram

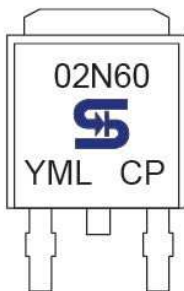

- Y** = Year Code
- M** = Month Code
(**A**=Jan, **B**=Feb, **C**=Mar, **D**=Apr, **E**=May, **F**=Jun, **G**=Jul, **H**=Aug, **I**=Sep, **J**=Oct, **K**=Nov, **L**=Dec)
- L** = Lot Code

Notice

Specifications of the products displayed herein are subject to change without notice. TSC or anyone on its behalf, assumes no responsibility or liability for any errors or inaccuracies.

Information contained herein is intended to provide a product description only. No license, express or implied, to any intellectual property rights is granted by this document. Except as provided in TSC's terms and conditions of sale for such products, TSC assumes no liability whatsoever, and disclaims any express or implied warranty, relating to sale and/or use of TSC products including liability or warranties relating to fitness for a particular purpose, merchantability, or infringement of any patent, copyright, or other intellectual property right.

The products shown herein are not designed for use in medical, life-saving, or life-sustaining applications. Customers using or selling these products for use in such applications do so at their own risk and agree to fully indemnify TSC for any damages resulting from such improper use or sale.