



Features

- ◇ Dual rectifier construction, positive center-tap
- ◇ Plastic package has Underwriters Laboratory Flammability Classification 94V0
- ◇ Glass passivated chip junctions
- ◇ Superfast recovery time, high voltage
- ◇ Low forward voltage, high current capability
- ◇ Low thermal resistance
- ◇ Low power loss, high efficiency
- ◇ High temperature soldering guaranteed: 260°C, 0.16"(4.06mm)from case for 10 seconds

Mechanical Data

- ◇ Cases: TO-3P/TO-247AD molded plastic
- ◇ Terminals: Pure tin plated, lead free solderable per MIL-STD-750. Method 2026
- ◇ Polarity: As marked
- ◇ Mounting position: Any
- ◇ Mounting torque: 10in.-lbs. Max.
- ◇ Weight: 0.2 ounce, 5.6 grams

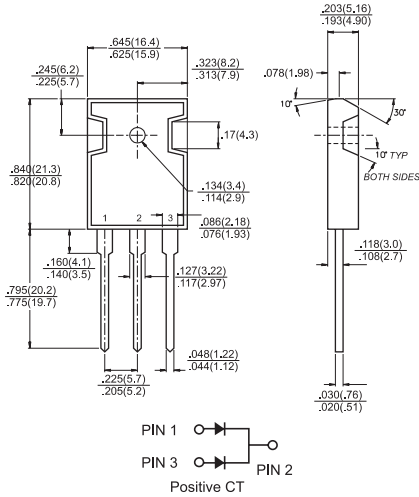

Dimensions in inches and (millimeters)

Maximum Ratings and Electrical Characteristics

Rating at 25 °C ambient temperature unless otherwise specified.

Single phase, half wave, 60 Hz, resistive or inductive load.

For capacitive load, derate current by 20%

Type Number	Symbol	HER	HER	HER	HER	HER	HER	HER	HER	Units
		3001PT	3002PT	3003PT	3004PT	3005PT	3006PT	3007PT	3008PT	
Maximum Recurrent Peak Reverse Voltage	V_{RRM}	50	100	200	300	400	600	800	1000	V
Maximum RMS Voltage	V_{RMS}	35	70	140	210	280	420	560	700	V
Maximum DC Blocking Voltage	V_{DC}	50	100	200	300	400	600	800	1000	V
Maximum Average Forward Rectified Current @ $T_C=100^\circ\text{C}$	$I_{(AV)}$	30								A
Peak Forward Surge Current, 8.3 ms Single Half Sine-wave Superimposed on Rated Load (JEDEC method)	I_{FSM}	300								A
Maximum Instantaneous Forward Voltage @15.0A	V_F	1.0			1.3		1.7			V
Maximum DC Reverse Current @ $T_C=25^\circ\text{C}$ at Rated DC Blocking Voltage @ $T_C=125^\circ\text{C}$	I_R	10 500								uA uA
Maximum Reverse Recovery Time (Note 2) @ $T_J=25^\circ\text{C}$	T_{rr}	50				80				nS
Typical Junction Capacitance (Note 1)	C_j	175				145				pF
Operating Temperature Range	T_J	-55 to +150								°C
Storage Temperature Range	T_{STG}	-55 to +150								°C

- Notes: 1. Measured at 1 MHz and Applied Reverse Voltage of 4.0 Volts.
2. Reverse Recovery Test Conditions: $I_F=0.5A$, $I_R=1.0A$, Recover to 0.25A.

RATINGS AND CHARACTERISTIC CURVES (HER3001PT THRU HER3008PT)

FIG.1- MAXIMUM FORWARD CURRENT DERATING CURVE

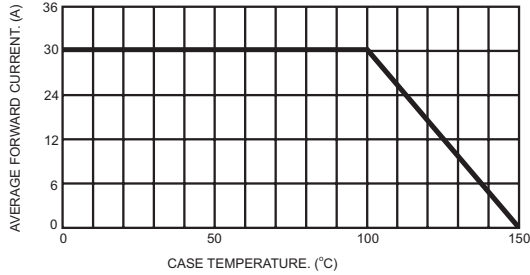

FIG.2- TYPICAL REVERSE CHARACTERISTICS PER LEG

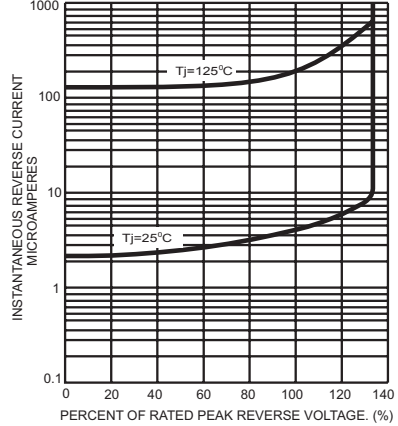

FIG.3- MAXIMUM NON-REPETITIVE FORWARD SURGE CURRENT PER LEG

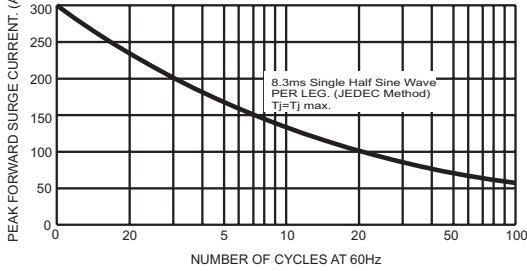

FIG.5- TYPICAL INSTANTANEOUS FORWARD CHARACTERISTICS PER LEG

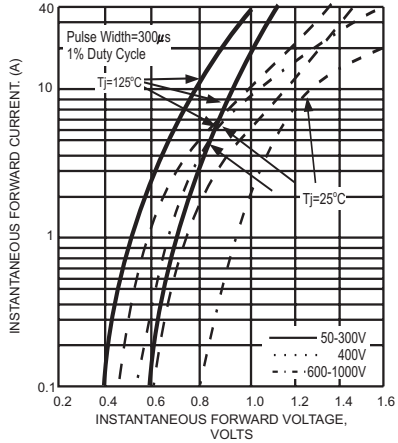

FIG.4- TYPICAL JUNCTION CAPACITANCE PER LEG

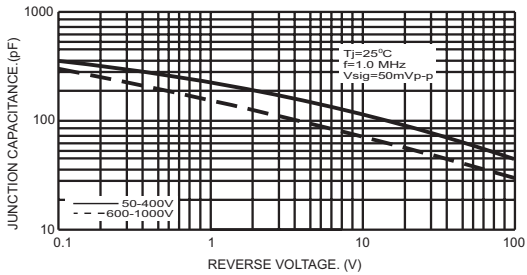
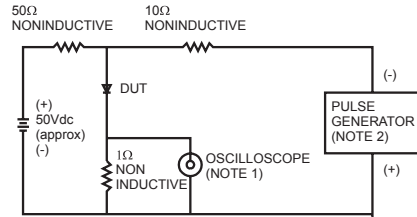

FIG.6- REVERSE RECOVERY TIME CHARACTERISTIC AND TEST CIRCUIT DIAGRAM



NOTES: 1. Rise Time=7ns max. Input Impedance= 1 megohm 22pf
2. Rise Time=10ns max. Source Impedance= 50 ohms

