

FDC633N N-Channel Enhancement Mode Field Effect Transistor

General Description

This N-Channel enhancement mode power field effect transistors is produced using Fairchild's proprietary, high cell density, DMOS technology. This very high density process is tailored to minimize on-state resistance. These devices are particularly suited for low voltage applications in notebook computers, portable phones, PCMCIA cards, and other battery powered circuits where fast switching, low in-line power loss and resistance to transients are needed in a very small outline surface mount package.

Features

- 5.2 A, 30 V. $R_{DS(ON)} = 0.042 \Omega @ V_{GS} = 4.5 V$
 $R_{DS(ON)} = 0.054 \Omega @ V_{GS} = 2.5 V.$
- SuperSOT™-6 package design using copper lead frame for superior thermal and electrical capabilities.
- High density cell design for extremely low $R_{DS(ON)}$.
- Exceptional on-resistance and maximum DC current capability.

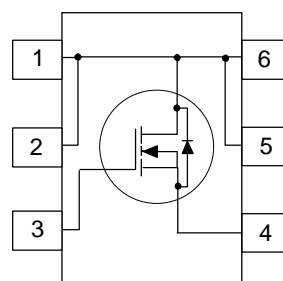
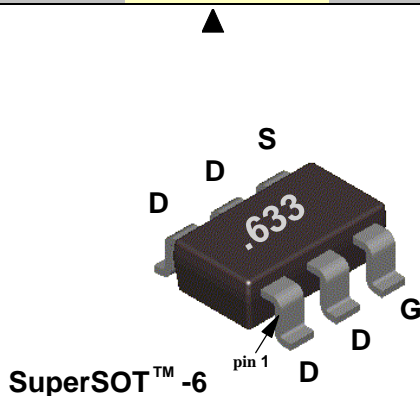
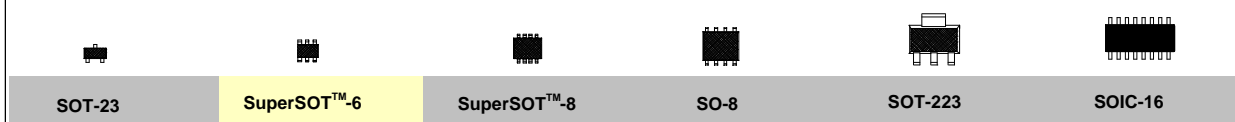

Absolute Maximum Ratings $T_A = 25^\circ\text{C}$ unless otherwise noted

Symbol	Parameter	FDC633N	Units
V_{DSS}	Drain-Source Voltage	30	V
V_{GSS}	Gate-Source Voltage - Continuous	± 8	V
I_D	Drain Current - Continuous (Note 1a)	5.2	A
	- Pulsed	16	
P_D	Maximum Power Dissipation (Note 1a) (Note 1b)	1.6	W
		0.8	
T_J, T_{STG}	Operating and Storage Temperature Range	-55 to 150	$^\circ\text{C}$

THERMAL CHARACTERISTICS

$R_{\theta JA}$	Thermal Resistance, Junction-to-Ambient (Note 1a)	78	$^\circ\text{C/W}$
$R_{\theta JC}$	Thermal Resistance, Junction-to-Case (Note 1)	30	$^\circ\text{C/W}$

ELECTRICAL CHARACTERISTICS ($T_A = 25^\circ\text{C}$ unless otherwise noted)

Symbol	Parameter	Conditions	Min	Typ	Max	Units	
OFF CHARACTERISTICS							
BV_{DSS}	Drain-Source Breakdown Voltage	$V_{GS} = 0\text{ V}, I_D = 250\ \mu\text{A}$	30			V	
$\Delta BV_{DSS}/\Delta T_J$	Breakdown Voltage Temp. Coefficient	$I_D = 250\ \mu\text{A}$, Referenced to 25°C		42		$\text{mV}/^\circ\text{C}$	
I_{DSS}	Zero Gate Voltage Drain Current	$V_{DS} = 24\text{ V}, V_{GS} = 0\text{ V}$			1	μA	
					10	μA	
		$T_J = 55^\circ\text{C}$					
I_{GSSF}	Gate - Body Leakage, Forward	$V_{GS} = 8\text{ V}, V_{DS} = 0\text{ V}$			100	nA	
I_{GSSR}	Gate - Body Leakage, Reverse	$V_{GS} = -8\text{ V}, V_{DS} = 0\text{ V}$			-100	nA	
ON CHARACTERISTICS (Note 2)							
$V_{GS(th)}$	Gate Threshold Voltage	$V_{DS} = V_{GS}, I_D = 250\ \mu\text{A}$	0.4	0.67	1	V	
$\Delta V_{GS(th)}/\Delta T_J$	Gate Threshold Voltage Temp. Coefficient	$I_D = 250\ \mu\text{A}$, Referenced to 25°C		-2.4		$\text{mV}/^\circ\text{C}$	
$R_{DS(on)}$	Static Drain-Source On-Resistance	$V_{GS} = 4.5\text{ V}, I_D = 5.2\text{ A}$		0.033	0.042	Ω	
					0.051		0.07
					0.043		0.054
		$T_J = 125^\circ\text{C}$					
		$V_{GS} = 2.5\text{ V}, I_D = 4.5\text{ A}$					
$I_{D(on)}$	On-State Drain Current	$V_{GS} = 4.5\text{ V}, V_{DS} = 5\text{ V}$	11			A	
g_{FS}	Forward Transconductance	$V_{DS} = 10\text{ V}, I_D = 5.2\text{ A}$		15		S	
DYNAMIC CHARACTERISTICS							
C_{iss}	Input Capacitance	$V_{DS} = 10\text{ V}, V_{GS} = 0\text{ V},$ $f = 1.0\text{ MHz}$		538		μF	
C_{oss}	Output Capacitance			226		μF	
C_{rss}	Reverse Transfer Capacitance			51		μF	
SWITCHING CHARACTERISTICS (Note 2)							
$t_{D(on)}$	Turn - On Delay Time	$V_{DD} = 5\text{ V}, I_D = 1\text{ A},$ $V_{GS} = 4.5\text{ V}, R_{GEN} = 6\ \Omega$		5	12	ns	
t_r	Turn - On Rise Time			17	27	ns	
$t_{D(off)}$	Turn - Off Delay Time			25	40	ns	
t_f	Turn - Off Fall Time			5.3	11	ns	
Q_g	Total Gate Charge	$V_{DS} = 10\text{ V}, I_D = 5.2\text{ A},$ $V_{GS} = 4.5\text{ V}$		11	16	nC	
Q_{gs}	Gate-Source Charge			2		nC	
Q_{gd}	Gate-Drain Charge			2.4		nC	
DRAIN-SOURCE DIODE CHARACTERISTICS							
I_S	Continuous Source Diode Current				1.3	A	
V_{SD}	Drain-Source Diode Forward Voltage	$V_{GS} = 0\text{ V}, I_S = 1.3\text{ A}$ (Note 2)		0.7	1.2	V	
					0.57		1
		$T_J = 125^\circ\text{C}$					

Notes:

1. $R_{\theta JA}$ is the sum of the junction-to-case and case-to-ambient thermal resistance where the case thermal reference is defined as the solder mounting surface of the drain pins. $R_{\theta JC}$ is guaranteed by design while $R_{\theta CA}$ is determined by the user's board design.

- $78^\circ\text{C}/\text{W}$ when mounted on a 1 in^2 pad of 2oz Cu on FR-4 board.
- $156^\circ\text{C}/\text{W}$ when mounted on a minimum pad of 2oz Cu on FR-4 board.

2. Pulse Test: Pulse Width $\leq 300\ \mu\text{s}$, Duty Cycle $\leq 2.0\%$.

Typical Electrical Characteristics

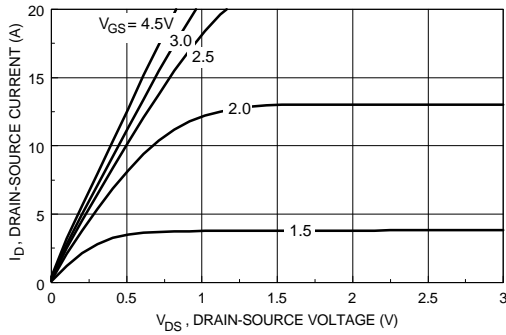

Figure 1. On-Region Characteristics.

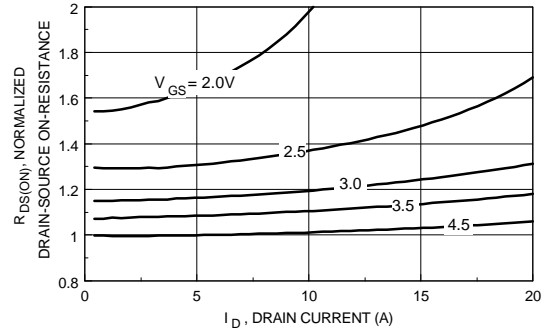

Figure 2. On-Resistance Variation with Drain Current and Gate Voltage.

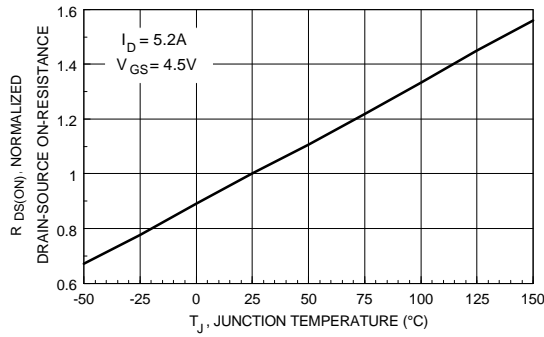

Figure 3. On-Resistance Variation with Temperature.

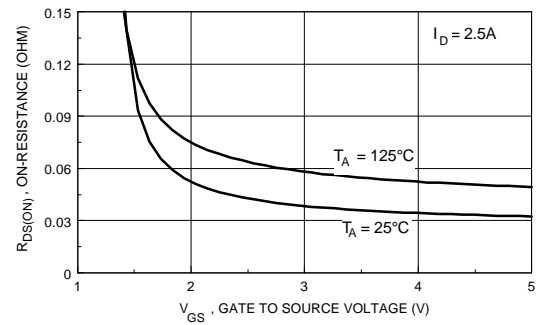

Figure 4. On-Resistance Variation with Gate-to-Source Voltage.

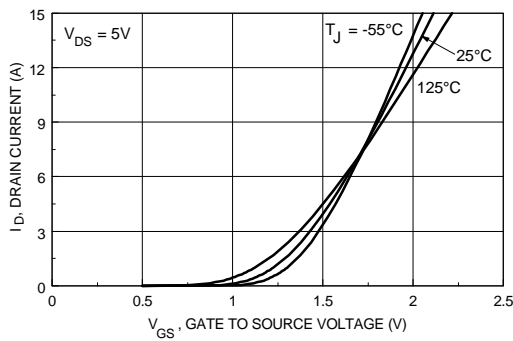

Figure 5. Transfer Characteristics.

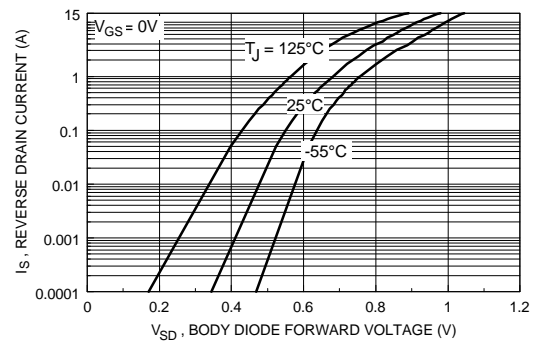

Figure 6. Body Diode Forward Voltage Variation with Source Current and Temperature.

Typical Electrical Characteristics (continued)

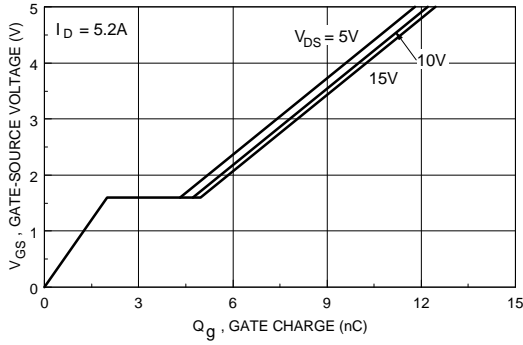

Figure 7. Gate Charge Characteristics.

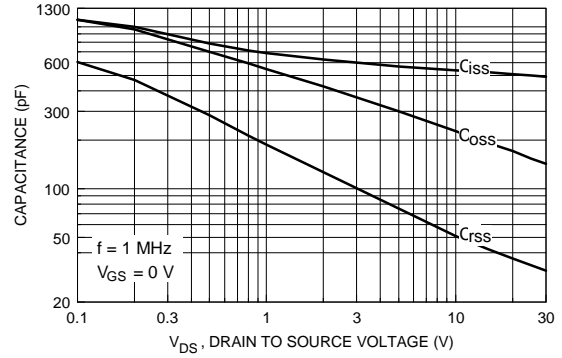

Figure 8. Capacitance Characteristics.

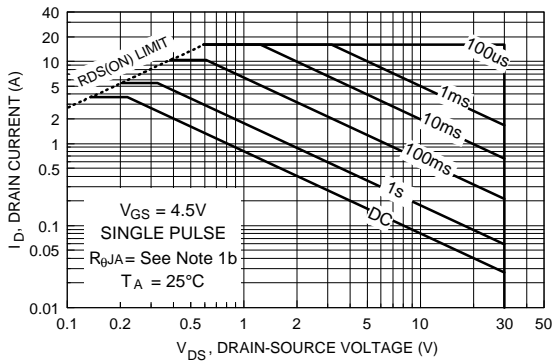

Figure 9. Maximum Safe Operating Area.

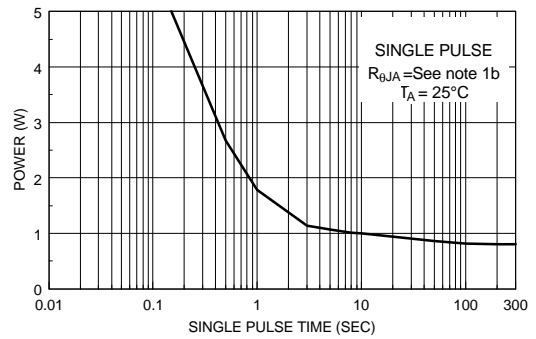

Figure 10. Single Pulse Maximum Power Dissipation.

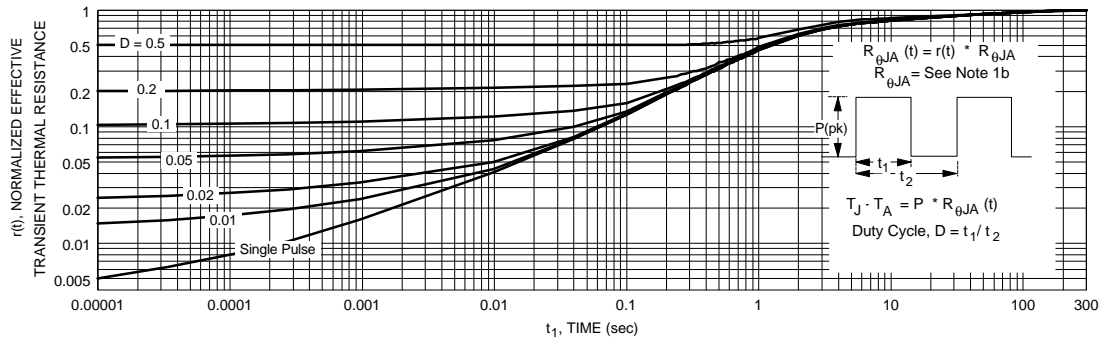

Figure 11. Transient Thermal Response Curve.

Thermal characterization performed using the conditions described in note 1b. Transient thermal response will change depending on the circuit board design.