

400MHz Slew Enhanced VFAs

The EL5x02 and EL5x03 families represent high-speed VFAs based on a CFA amplifier architecture. This gives the typical high slew rate benefits of a CFA family along with the stability and ease of use associated with the VFA type architecture. With slew rates of 3500V/μs, this family of devices enables the use of voltage feedback amplifiers in a space where the only alternative has been current feedback amplifiers. This family will also be available in single, dual, and triple versions, with 200MHz, 400MHz, and 750MHz versions. These are all available in single, dual, and triple versions.

Both families operate on single 5V or ±5V supplies from minimum supply current. EL5x02 also features an output enable function, which can be used to put the output in to a high-impedance mode. This enables the outputs of multiple amplifiers to be tied together for use in multiplexing applications.

Typical applications for these families will include cable driving, filtering, A-to-D and D-to-A buffering, multiplexing and summing within video, communications, and instrumentation designs.

Features

- Operates off 3V, 5V, or ±5V applications
- Power-down to 0μA (EL5x02)
- -3dB bandwidth = 400MHz
- ±0.1dB bandwidth = 50MHz
- Low supply current = 5mA
- Slew rate = 3500V/μs
- Low offset voltage = 5mV max
- Output current = 140mA
- $A_{VOL} = 2000$
- Diff gain/phase = 0.01%/0.01°
- Pb-Free plus anneal available (RoHS compliant)

Applications

- Video amplifiers
- PCMCIA applications
- A/D drivers
- Line drivers
- Portable computers
- High speed communications
- RGB applications
- Broadcast equipment
- Active filtering

EL5102, EL5103, EL5202, EL5203, EL5302

Ordering Information

| PART NUMBER | PART MARKING | PACKAGE | TAPE & REEL | PKG. DWG. # |
|-----------------------------|--------------|--------------------------|-----------------|-------------|
| EL5102IS | 5102IS | 8 Ld SOIC | - | MDP0027 |
| EL5102IS-T7 | 5102IS | 8 Ld SOIC | 7" | MDP0027 |
| EL5102IS-T13 | 5102IS | 8 Ld SOIC | 13" | MDP0027 |
| EL5102ISZ (See Note) | 5102ISZ | 8 Ld SOIC (Pb-free) | - | MDP0027 |
| EL5102ISZ-T7 (See Note) | 5102ISZ | 8 Ld SOIC (Pb-free) | 7" | MDP0027 |
| EL5102ISZ-T13 (See Note) | 5102ISZ | 8 Ld SOIC (Pb-free) | 13" | MDP0027 |
| EL5102IW-T7 | q | 6 Ld SOT-23 | 7" (3K pcs) | MDP0038 |
| EL5102IW-T7A | q | 6 Ld SOT-23 | 7" (250 pcs) | MDP0038 |
| EL5102IWZ-T7 (See Note) | BBSA | 6 Ld SOT-23 (Pb-free) | 7" (3K pcs) | MDP0038 |
| EL5102IWZ-T7A (See Note) | BBSA | 6 Ld SOT-23 (Pb-free) | 7" (250 pcs) | MDP0038 |
| EL5103IC-T7 | B | 5 Ld SC-70 | 7" (3K pcs) | P5.049 |
| EL5103IC-T7A | B | 5 Ld SC-70 | 7" (250 pcs) | P5.049 |
| EL5103IW-T7 | g | 5 Ld SOT-23 | 7" (3K pcs) | MDP0038 |
| EL5103IWZ-T7 | BBTA | 5 Ld SOT-23 (Pb-free) | 7" (3K pcs) | MDP0038 |
| EL5103IWZ-T7A | BBTA | 5 Ld SOT-23 (Pb-free) | 7" (250 pcs) | MDP0038 |
| EL5202IY | BRAAA | 10 Ld MSOP | - | MDP0043 |
| EL5202IY-T7 | BRAAA | 10 Ld MSOP | 7" | MDP0043 |
| EL5202IY-T13 | BRAAA | 10 Ld MSOP | 13" | MDP0043 |
| EL5202IYZ (See Note) | BAAAD | 10 Ld MSOP (Pb-free) | - | MDP0043 |
| EL5202IYZ-T7 (See Note) | BAAAD | 10 Ld MSOP (Pb-free) | 7" | MDP0043 |
| EL5202IYZ-T13 (See Note) | BAAAD | 10 Ld MSOP (Pb-free) | 13" | MDP0043 |
| EL5203IS | 5203IS | 8 Ld SOIC | - | MDP0027 |
| EL5203IS-T7 | 5203IS | 8 Ld SOIC | 7" | MDP0027 |
| EL5203IS-T13 | 5203IS | 8 Ld SOIC | 13" | MDP0027 |
| EL5203ISZ (See Note) | 5203ISZ | 8 Ld SOIC (Pb-free) | - | MDP0027 |

Ordering Information (Continued)

| PART NUMBER | PART MARKING | PACKAGE | TAPE & REEL | PKG. DWG. # |
|-----------------------------|--------------|-------------------------|-------------|-------------|
| EL5203ISZ-T7 (See Note) | 5203ISZ | 8 Ld SOIC (Pb-free) | 7" | MDP0027 |
| EL5203ISZ-T13 (See Note) | 5203ISZ | 8 Ld SOIC (Pb-free) | 13" | MDP0027 |
| EL5203IY | BSAAA | 8 Ld MSOP | - | MDP0043 |
| EL5203IY-T7 | BSAAA | 8 Ld MSOP | 7" | MDP0043 |
| EL5203IY-T13 | BSAAA | 8 Ld MSOP | 13" | MDP0043 |
| EL5203IYZ (See Note) | BAAAE | 8 Ld MSOP (Pb-free) | - | MDP0043 |
| EL5203IYZ-T7 (See Note) | BAAAE | 8 Ld MSOP (Pb-free) | 7" | MDP0043 |
| EL5203IYZ-T13 (See Note) | BAAAE | 8 Ld MSOP (Pb-free) | 13" | MDP0043 |
| EL5302IU | 5302IU | 16 Ld QSOP | - | MDP0040 |
| EL5302IU-T7 | 5302IU | 16 Ld QSOP | 7" | MDP0040 |
| EL5302IU-T13 | 5302IU | 16 Ld QSOP | 13" | MDP0040 |
| EL5302IUZ (See Note) | 5302IUZ | 16 Ld QSOP (Pb-free) | - | MDP0040 |
| EL5302IUZ-T7 (See Note) | 5302IUZ | 16 Ld QSOP (Pb-free) | 7" | MDP0040 |
| EL5302IUZ-T13 (See Note) | 5302IUZ | 16 Ld QSOP (Pb-free) | 13" | MDP0040 |

NOTE: Intersil Pb-free plus anneal products employ special Pb-free material sets; molding compounds/die attach materials and 100% matte tin plate termination finish, which are RoHS compliant and compatible with both SnPb and Pb-free soldering operations. Intersil Pb-free products are MSL classified at Pb-free peak reflow temperatures that meet or exceed the Pb-free requirements of IPC/JEDEC J STD-020

EL5102, EL5103, EL5202, EL5203, EL5302

Pinouts

EL5102
(6 LD SOT-23)
TOP VIEW

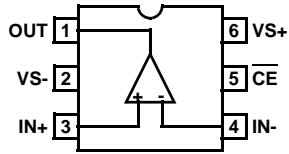

EL5103
(5 LD SOT-23)
TOP VIEW

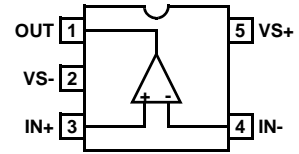

EL5102
(8 LD SOIC)
TOP VIEW

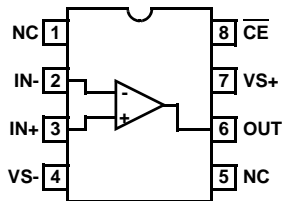

EL5203
(8 LD SOIC, MSOP)
TOP VIEW

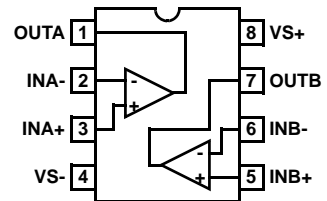

EL5202
(10 LD MSOP)
TOP VIEW

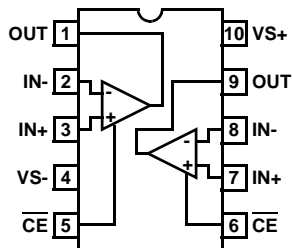

EL5302
(16 LD QSOP)
TOP VIEW

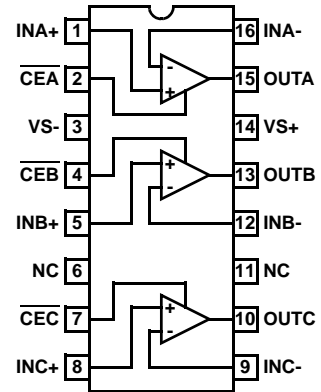

EL5102, EL5103, EL5202, EL5203, EL5302

Absolute Maximum Ratings ($T_A = 25^\circ\text{C}$)

| | | | |
|---|-------------------------|--|---|
| Supply Voltage between V_{S+} and GND | 13.2V | Maximum Current into I_{N+} , I_{N-} , \overline{CE} | $\pm 5\text{mA}$ |
| Maximum Supply Slewrate between V_{S+} and V_{S-} | $1\text{V}/\mu\text{s}$ | Power Dissipation | See Curves |
| Input Voltage | $\pm V_S$ | Storage Temperature Range | -65°C to $+150^\circ\text{C}$ |
| Differential Input Voltage | $\pm 4\text{V}$ | Ambient Operating Temperature Range | -40°C to $+85^\circ\text{C}$ |
| Maximum Continuous Output Current | 80mA | Operating Junction Temperature | 150°C |

CAUTION: Stresses above those listed in "Absolute Maximum Ratings" may cause permanent damage to the device. This is a stress only rating and operation of the device at these or any other conditions above those indicated in the operational sections of this specification is not implied.

IMPORTANT NOTE: All parameters having Min/Max specifications are guaranteed. Typical values are for information purposes only. Unless otherwise noted, all tests are at the specified temperature and are pulsed tests, therefore: $T_J = T_C = T_A$

DC Electrical Specifications $V_{S+} = +5\text{V}$, $V_{S-} = -5\text{V}$, $T_A = 25^\circ\text{C}$, $R_L = 500\Omega$, $V_{ENABLE} = +5\text{V}$, unless otherwise specified.

| PARAMETER | DESCRIPTION | CONDITIONS | MIN | TYP | MAX | UNIT |
|-------------------------|--|--|--------------|-----------|--------------|------------------------------|
| V_{OS} | Offset Voltage | EL5102, EL5103, EL5202, EL5203 | | 1 | 5 | mV |
| | | EL5302 | | 2 | 8 | mV |
| TCV_{OS} | Offset Voltage Temperature Coefficient | Measured from T_{MIN} to T_{MAX} | | 10 | | $\mu\text{V}/^\circ\text{C}$ |
| I_B | Input Bias Current | $V_{IN} = 0\text{V}$ | -12 | 2 | 12 | μA |
| I_{OS} | Input Offset Current | $V_{IN} = 0\text{V}$ | -8 | 1 | 8 | μA |
| TCI_{OS} | Input Bias Current Temperature Coefficient | Measured from T_{MIN} to T_{MAX} | | 50 | | $\text{nA}/^\circ\text{C}$ |
| PSRR | Power Supply Rejection Ratio | $V_S = \pm 4.75\text{V}$ to $\pm 5.25\text{V}$ | -70 | -80 | | dB |
| CMRR | Common Mode Rejection Ratio | $V_{CM} = -3\text{V}$ to 3.0V | -60 | -80 | | dB |
| CMIR | Common Mode Input Range | Guaranteed by CMRR test | -3 | ± 3.3 | 3 | V |
| R_{IN} | Input Resistance | Common mode | 200 | 400 | | $\text{k}\Omega$ |
| C_{IN} | Input Capacitance | SO package | | 1 | | pF |
| $I_{S,ON}$ | Supply Current - Enabled per amplifier | | 4.6 | 5.2 | 5.8 | mA |
| $I_{S,OFF}$ | Supply Current - Shut-down per amplifier | V_{S+} | +1 | 0 | +25 | μA |
| | | V_{S-} | -25 | 7 | -1 | μA |
| AVOL | Open Loop Gain | $V_{OUT} = \pm 2.5\text{V}$, $R_L = 1\text{k}\Omega$ to GND | 58 | 66 | | dB |
| | | $V_{OUT} = \pm 2.5\text{V}$, $R_L = 150\Omega$ to GND | | 60 | | dB |
| V_{OUT} | Output Voltage Swing | $R_L = 1\text{k}\Omega$ to GND | ± 3.5 | ± 3.9 | | V |
| | | $R_L = 150\Omega$ to GND | ± 3.4 | ± 3.7 | | V |
| I_{OUT} | Output Current | $A_V = 1$, $R_L = 10\Omega$ to 0V | ± 80 | ± 150 | | mA |
| $V_{\overline{CE-ON}}$ | \overline{CE} Pin Voltage for Power-up | | $(V_{S+})-5$ | | $(V_{S+})-3$ | V |
| $V_{\overline{CE-OFF}}$ | \overline{CE} Pin Voltage for Shut-down | | $(V_{S+})-1$ | | V_{S+} | V |
| I_{EN-ON} | Pin Current - Enabled | $\overline{CE} = 0\text{V}$ | -1 | 0 | +1 | μA |
| I_{EN-OFF} | Pin Current - Disabled | $\overline{CE} = +5\text{V}$ | 1 | 14 | 25 | μA |

EL5102, EL5103, EL5202, EL5203, EL5302

Closed Loop AC Electrical Specifications $V_{S+} = +5V$, $V_{S-} = -5V$, $T_A = 25^{\circ}C$, $V_{ENABLE} = +5V$, $A_V = +1$, $R_F = 0\Omega$, $R_L = 150\Omega$ to GND pin, unless otherwise specified. (Note 1)

| PARAMETER | DESCRIPTION | CONDITIONS | MIN | TYP | MAX | UNIT |
|------------|--|---|------|------|------|-----------------|
| BW | -3dB Bandwidth ($V_{OUT} = 400mV_{P-P}$) | $A_V = 1$, $R_F = 0\Omega$ | | 400 | | MHz |
| SR | Slew Rate | $A_V = +2$, $R_L = 100\Omega$, $V_{OUT} = -3V$ to $+3V$ | 1100 | 2200 | 5000 | V/ μ s |
| | | $R_L = 500\Omega$, $V_{OUT} = -3V$ to $+3V$ | | 4000 | | V/ μ s |
| t_R, t_F | Rise Time, Fall Time | $\pm 0.1V$ step | | 2.8 | | ns |
| OS | Overshoot | $\pm 0.1V$ step | | 10 | | % |
| t_S | 0.1% Settling Time | $V_S = \pm 5V$, $R_L = 500\Omega$, $A_V = 1$, $V_{OUT} = \pm 3V$ | | 20 | | ns |
| dG | Differential Gain (Note 2) | $A_V = 2$, $R_F = 1k\Omega$ | | 0.01 | | % |
| dP | Differential Phase (Note 2) | $A_V = 2$, $R_F = 1k\Omega$ | | 0.01 | | $^{\circ}$ |
| e_N | Input Noise Voltage | $f = 10kHz$ | | 12 | | nV/ \sqrt{Hz} |
| i_N | Input Noise Current | $f = 10kHz$ | | 11 | | pA/ \sqrt{Hz} |
| t_{DIS} | Disable Time (Note 3) | | | 50 | | ns |
| t_{EN} | Enable Time (Note 3) | | | 25 | | ns |

NOTES:

- All AC tests are performed on a "warmed up" part, except slew rate, which is pulse tested.
- Standard NTSC signal = $286mV_{P-P}$, $f = 3.58MHz$, as V_{IN} is swept from 0.6V to 1.314V. R_L is DC coupled.
- Disable/Enable time is defined as the time from when the logic signal is applied to the ENABLE pin to when the supply current has reached half its final value.

Typical Performance Curves

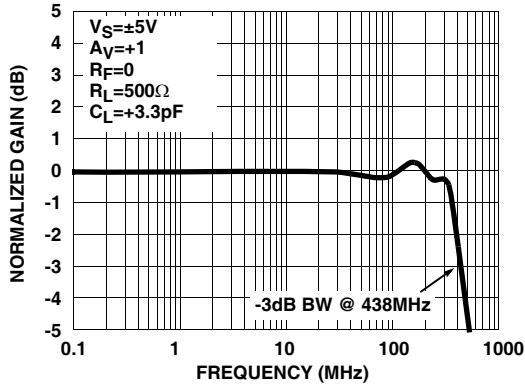

FIGURE 1. GAIN vs FREQUENCY (-3dB BANDWIDTH)

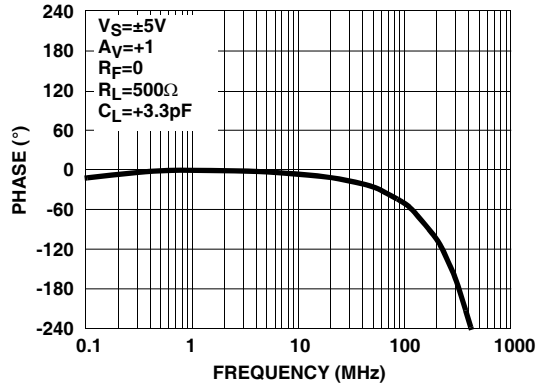

FIGURE 2. PHASE vs FREQUENCY

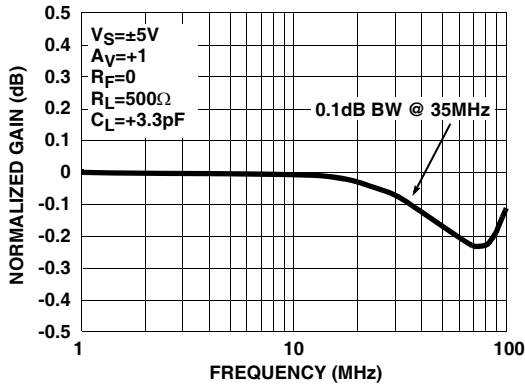

FIGURE 3. 0.1dB BANDWIDTH

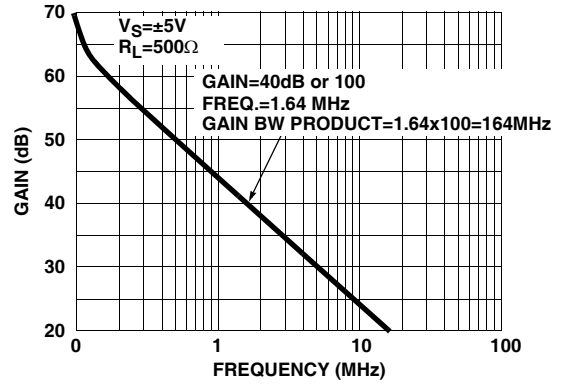

FIGURE 4. GAIN BANDWIDTH PRODUCT

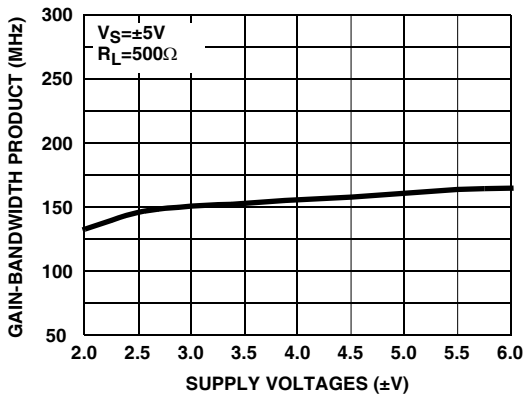

FIGURE 5. GAIN BANDWIDTH PRODUCT vs SUPPLY VOLTAGES

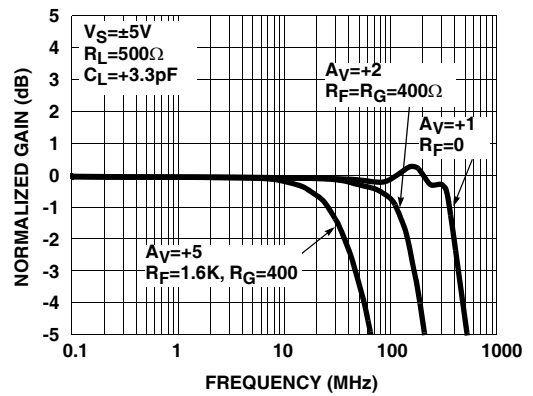

FIGURE 6. GAIN vs FREQUENCY FOR VARIOUS A_V

Typical Performance Curves (Continued)

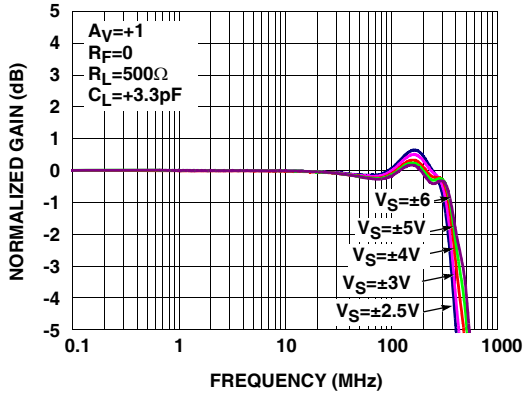

FIGURE 7. GAIN vs FREQUENCY FOR VARIOUS $\pm V_S$

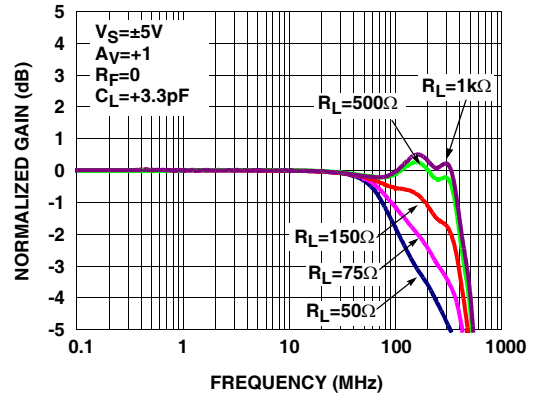

FIGURE 8. GAIN vs FREQUENCY FOR VARIOUS R_{LOAD} ($A_V = +1$)

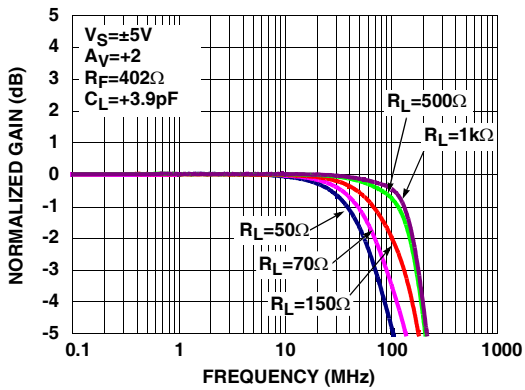

FIGURE 9. GAIN vs FREQUENCY FOR VARIOUS R_{LOAD} ($A_V = +2$)

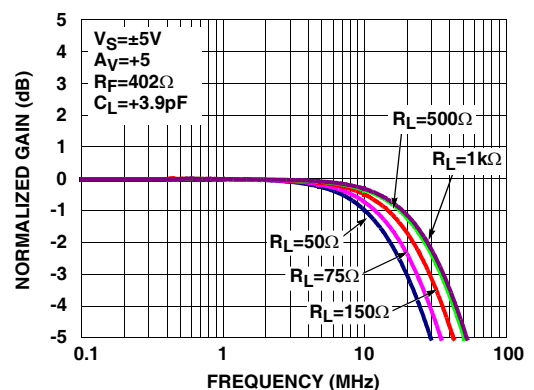

FIGURE 10. GAIN vs FREQUENCY FOR VARIOUS R_{LOAD} ($A_V = +5$)

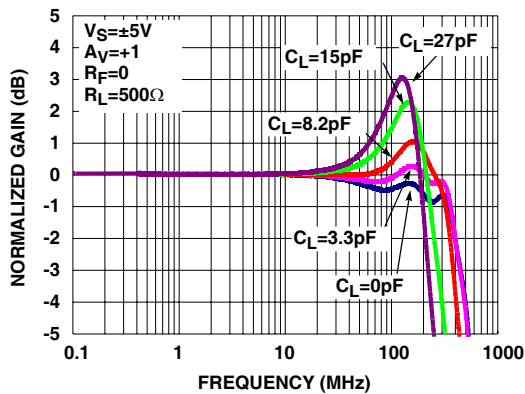

FIGURE 11. GAIN vs FREQUENCY FOR VARIOUS C_{LOAD} ($A_V = +1$)

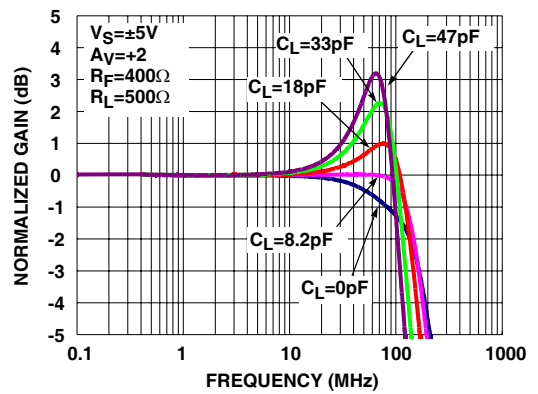

FIGURE 12. GAIN vs FREQUENCY FOR VARIOUS C_{LOAD} ($A_V = +2$)

Typical Performance Curves (Continued)

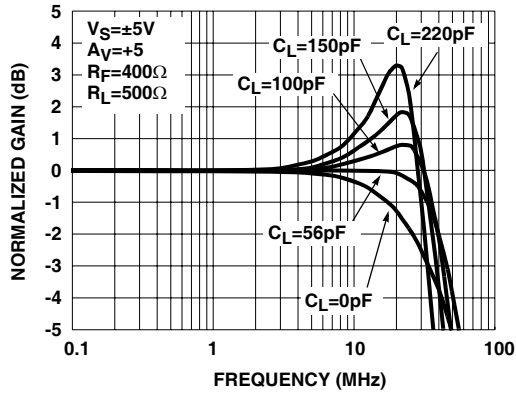

FIGURE 13. GAIN vs FREQUENCY FOR VARIOUS C_{LOAD} ($A_V = +5$)

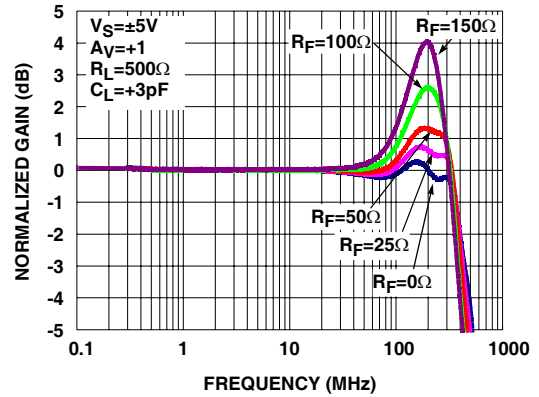

FIGURE 14. GAIN vs FREQUENCY FOR VARIOUS R_F ($A_V = +1$)

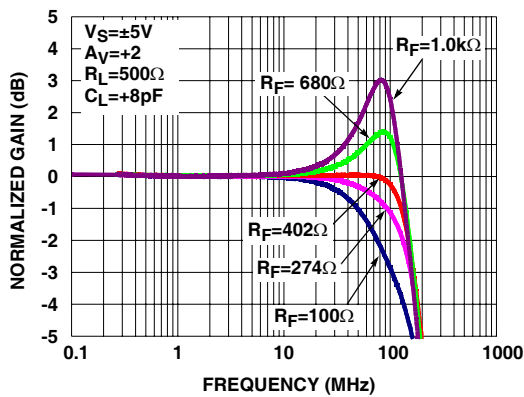

FIGURE 15. GAIN vs FREQUENCY FOR VARIOUS R_F ($A_V = +2$)

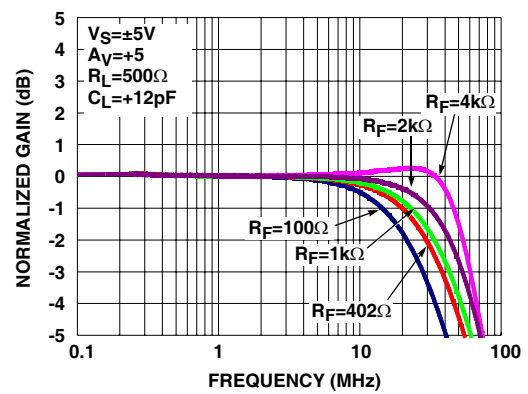

FIGURE 16. GAIN vs FREQUENCY FOR VARIOUS R_F ($A_V = +5$)

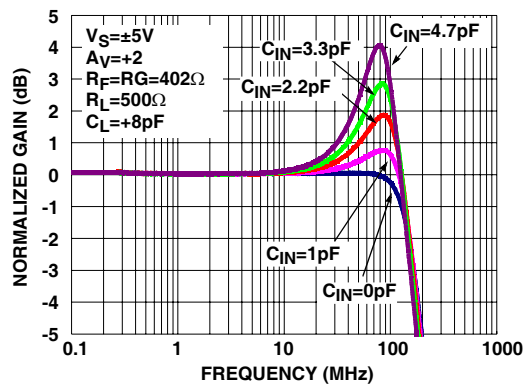

FIGURE 17. GAIN vs FREQUENCY FOR VARIOUS $C_{IN(-)}$ ($A_V = +2$)

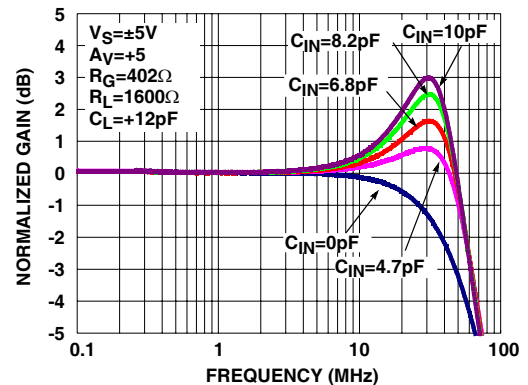

FIGURE 18. GAIN vs FREQUENCY FOR VARIOUS $C_{IN(-)}$ ($A_V = +5$)

Typical Performance Curves (Continued)

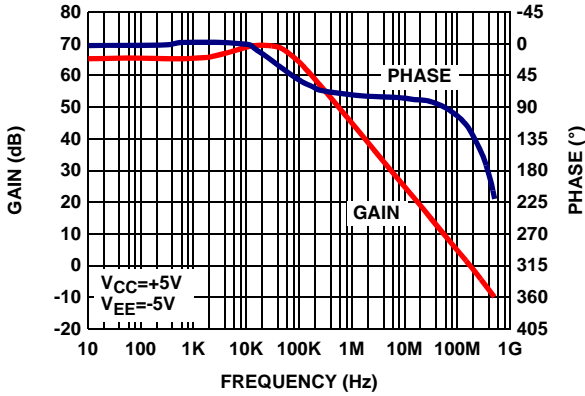

FIGURE 19. OPEN LOOP GAIN AND PHASE vs FREQUENCY

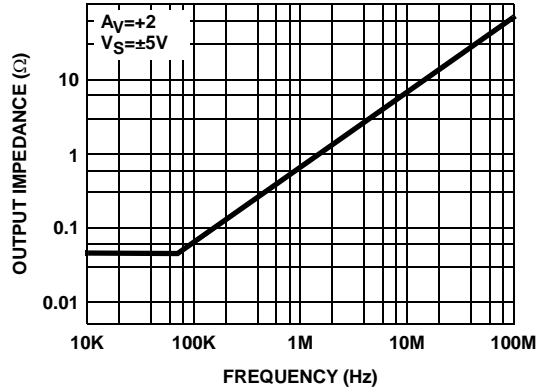

FIGURE 20. OUTPUT IMPEDANCE/PHASE vs FREQUENCY

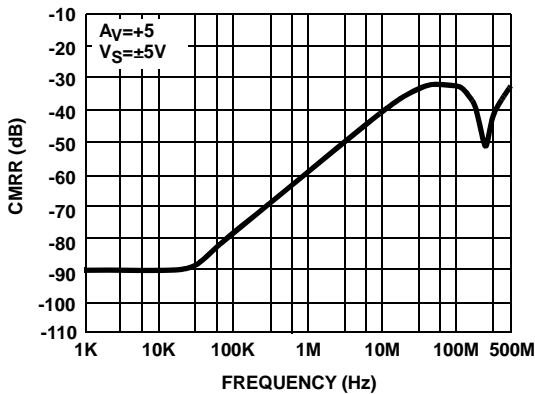

FIGURE 21. CMRR vs FREQUENCY

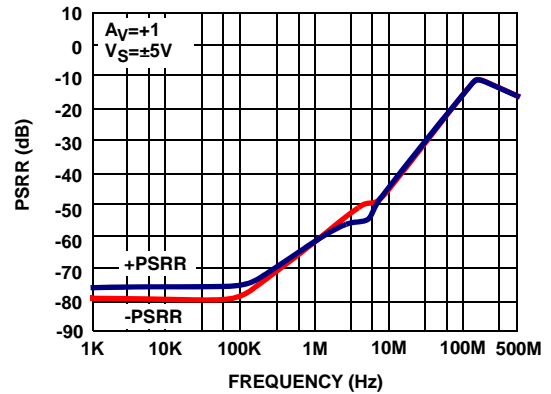

FIGURE 22. PSRR vs FREQUENCY

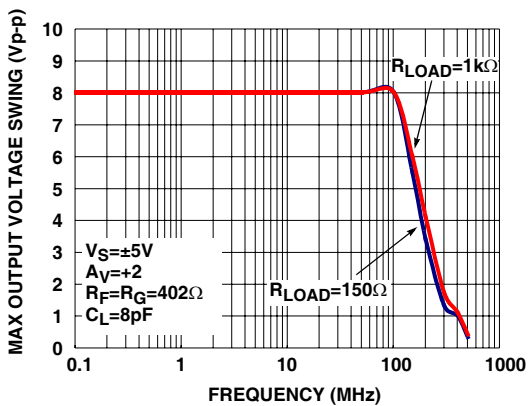

FIGURE 23. MAX OUTPUT VOLTAGE SWING vs FREQUENCY

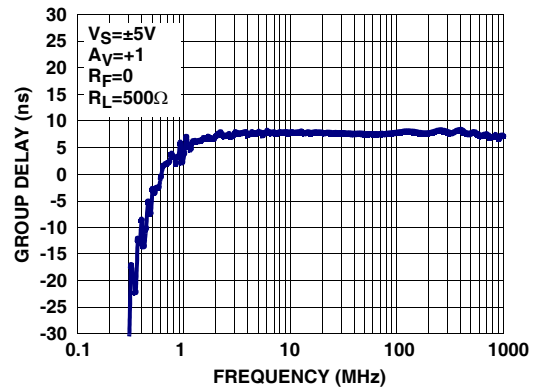

FIGURE 24. GROUP DELAY vs FREQUENCY

Typical Performance Curves (Continued)

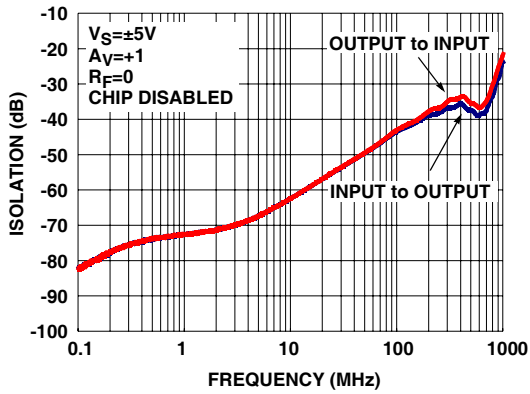

FIGURE 25. INPUT AND OUTPUT ISOLATION

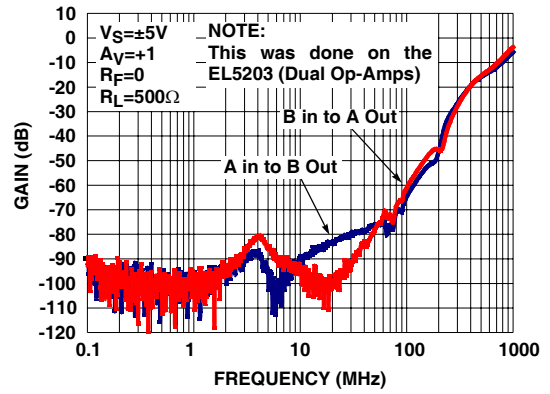

FIGURE 26. CHANNEL TO CHANNEL ISOLATION

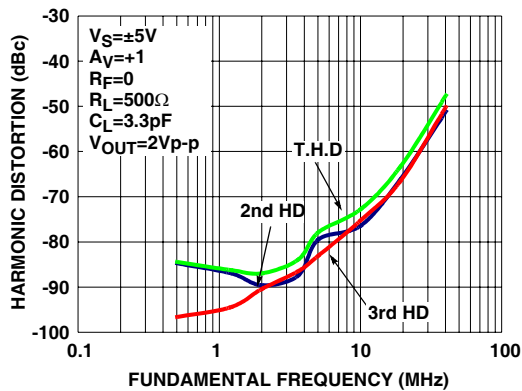

FIGURE 27. HARMONIC DISTORTION vs FREQUENCY

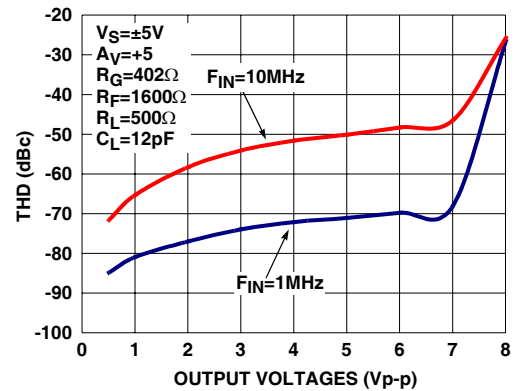

FIGURE 28. TOTAL HARMONIC DISTORTION vs OUTPUT VOLTAGES

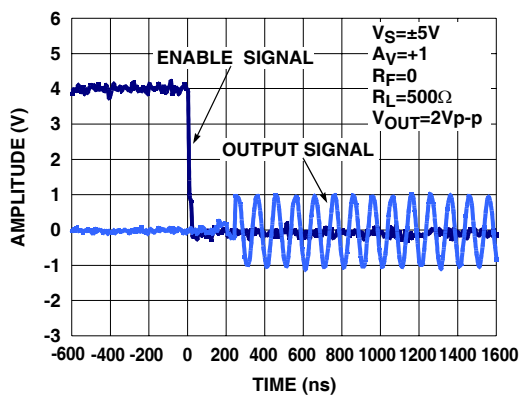

FIGURE 29. TURN-ON TIME

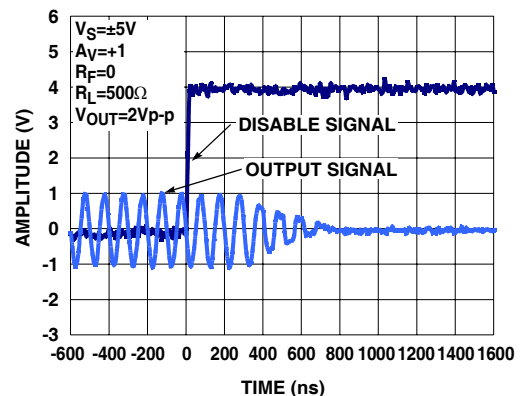

FIGURE 30. TURN-OFF TIME

Typical Performance Curves (Continued)

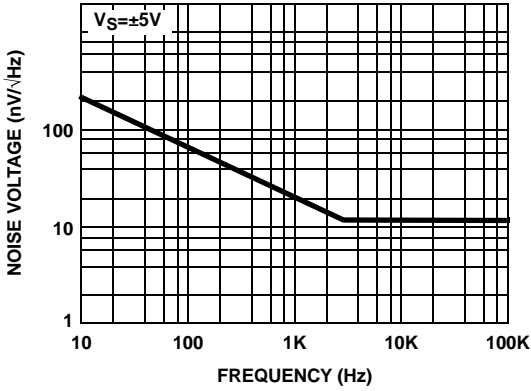

FIGURE 31. EQUIVALENT NOISE VOLTAGE vs FREQUENCY

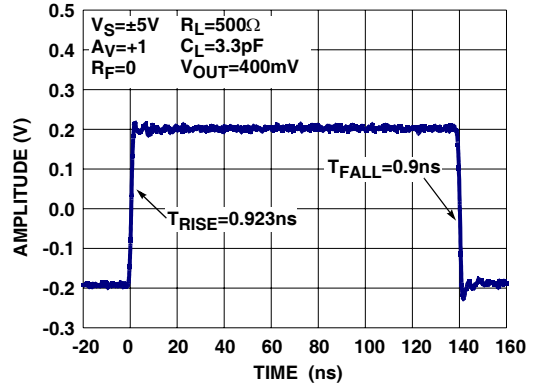

FIGURE 32. SMALL SIGNAL STEP RESPONSE_RISE AND FALL TIME

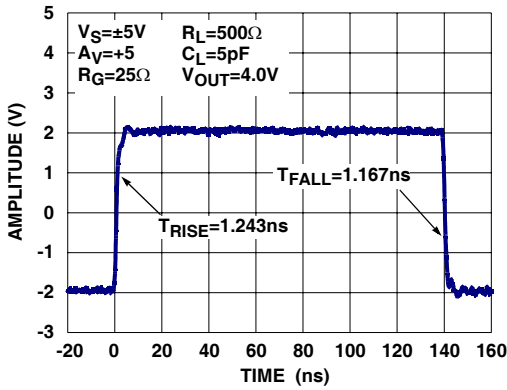

FIGURE 33. LARGE SIGNAL STEP RESPONSE_RISE AND FALL TIME

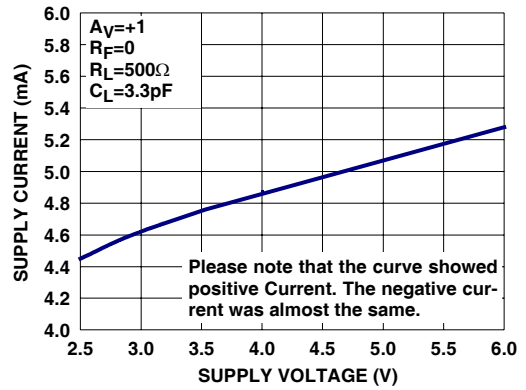

FIGURE 34. SUPPLY CURRENT vs SUPPLY VOLTAGE

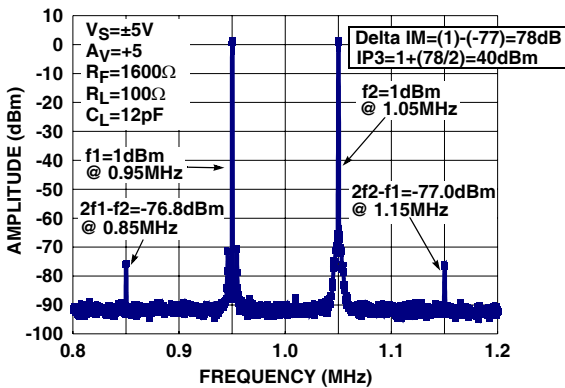

FIGURE 35. THIRD ORDER IMD INTERCEPT (IP3)

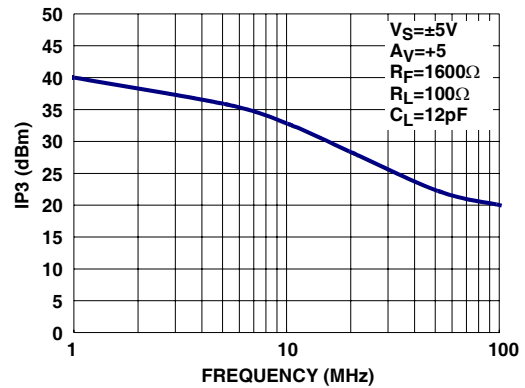

FIGURE 36. THIRD ORDER IMD INTERCEPT vs FREQUENCY

Typical Performance Curves (Continued)

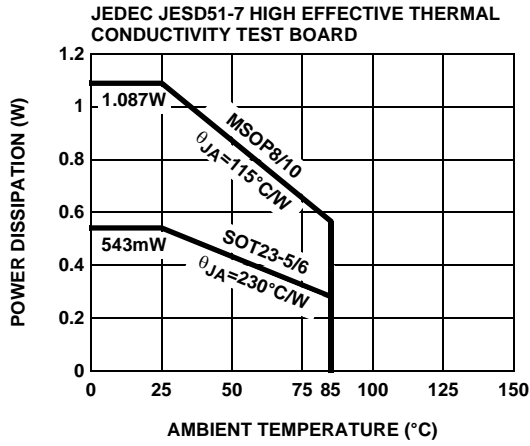

FIGURE 37. PACKAGE POWER DISSIPATION vs AMBIENT TEMPERATURE

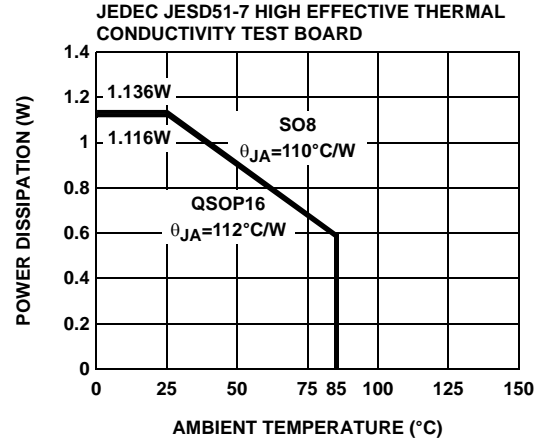

FIGURE 38. PACKAGE POWER DISSIPATION vs AMBIENT TEMPERATURE

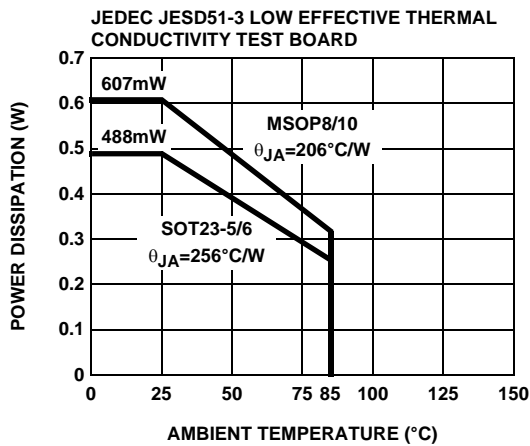

FIGURE 39. PACKAGE POWER DISSIPATION vs AMBIENT TEMPERATURE

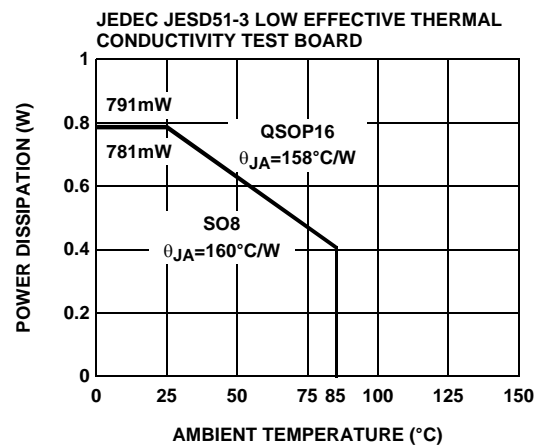
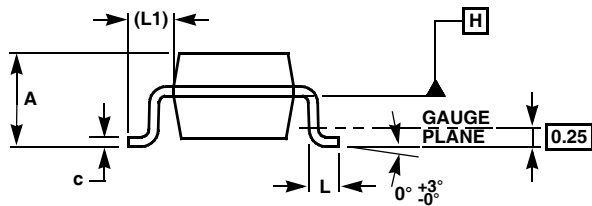
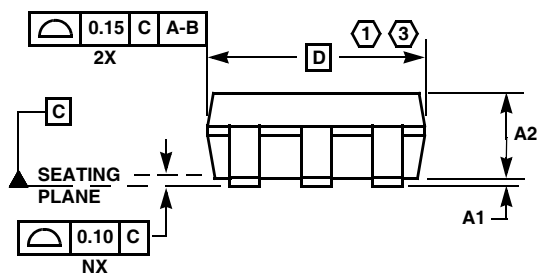
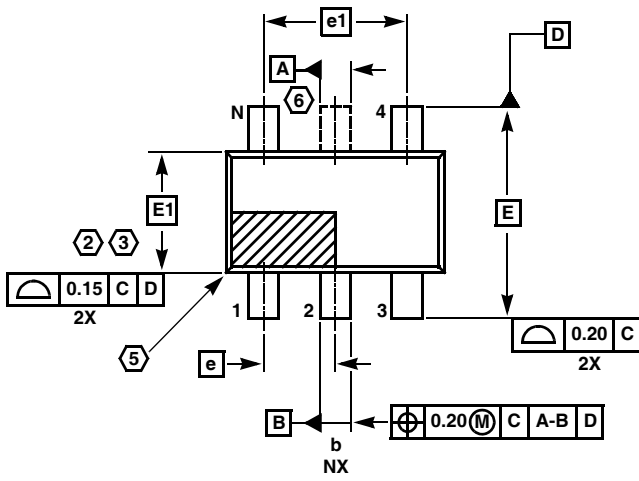

FIGURE 40. PACKAGE POWER DISSIPATION vs AMBIENT TEMPERATURE

SOT-23 Package Family



MDP0038

SOT-23 PACKAGE FAMILY

| SYMBOL | SOT23-5 | SOT23-6 | TOLERANCE |
|--------|---------|---------|-----------|
| A | 1.45 | 1.45 | MAX |
| A1 | 0.10 | 0.10 | ±0.05 |
| A2 | 1.14 | 1.14 | ±0.15 |
| b | 0.40 | 0.40 | ±0.05 |
| c | 0.14 | 0.14 | ±0.06 |
| D | 2.90 | 2.90 | Basic |
| E | 2.80 | 2.80 | Basic |
| E1 | 1.60 | 1.60 | Basic |
| e | 0.95 | 0.95 | Basic |
| e1 | 1.90 | 1.90 | Basic |
| L | 0.45 | 0.45 | ±0.10 |
| L1 | 0.60 | 0.60 | Reference |
| N | 5 | 6 | Reference |

Rev. E 3/00

NOTES:

1. Plastic or metal protrusions of 0.25mm maximum per side are not included.
2. Plastic interlead protrusions of 0.25mm maximum per side are not included.
3. This dimension is measured at Datum Plane "H".
4. Dimensioning and tolerancing per ASME Y14.5M-1994.
5. Index area - Pin #1 I.D. will be located within the indicated zone (SOT23-6 only).
6. SOT23-5 version has no center lead (shown as a dashed line).

Quarter Size Outline Plastic Packages Family (QSOP)

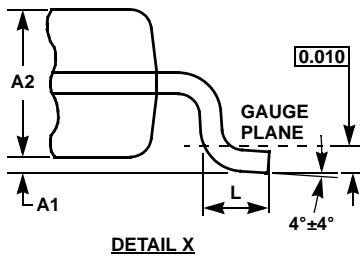
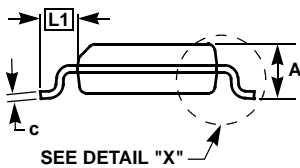
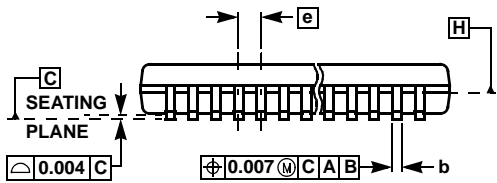
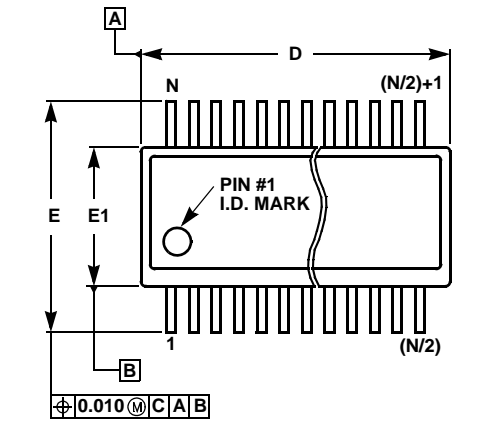

MDP0040

QUARTER SIZE OUTLINE PLASTIC PACKAGES FAMILY

| SYMBOL | QSOP16 | QSOP24 | QSOP28 | TOLERANCE | NOTES |
|--------|--------|--------|--------|-----------|-------|
| A | 0.068 | 0.068 | 0.068 | Max. | - |
| A1 | 0.006 | 0.006 | 0.006 | ±0.002 | - |
| A2 | 0.056 | 0.056 | 0.056 | ±0.004 | - |
| b | 0.010 | 0.010 | 0.010 | ±0.002 | - |
| c | 0.008 | 0.008 | 0.008 | ±0.001 | - |
| D | 0.193 | 0.341 | 0.390 | ±0.004 | 1, 3 |
| E | 0.236 | 0.236 | 0.236 | ±0.008 | - |
| E1 | 0.154 | 0.154 | 0.154 | ±0.004 | 2, 3 |
| e | 0.025 | 0.025 | 0.025 | Basic | - |
| L | 0.025 | 0.025 | 0.025 | ±0.009 | - |
| L1 | 0.041 | 0.041 | 0.041 | Basic | - |
| N | 16 | 24 | 28 | Reference | - |

Rev. E 3/01

NOTES:

1. Plastic or metal protrusions of 0.006" maximum per side are not included.
2. Plastic interlead protrusions of 0.010" maximum per side are not included.
3. Dimensions "D" and "E1" are measured at Datum Plane "H".
4. Dimensioning and tolerancing per ASME Y14.5M-1994.

Mini SO Package Family (MSOP)

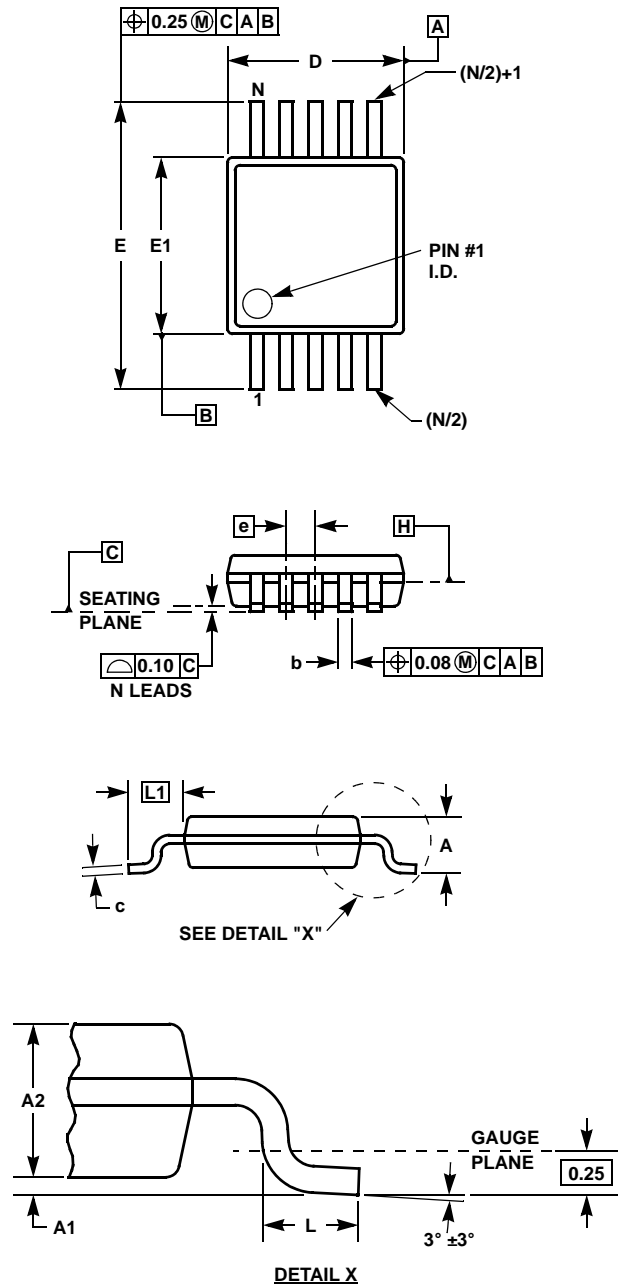

MDP0043

MINI SO PACKAGE FAMILY

| SYMBOL | MSOP8 | MSOP10 | TOLERANCE | NOTES |
|--------|-------|--------|---------------|-------|
| A | 1.10 | 1.10 | Max. | - |
| A1 | 0.10 | 0.10 | ± 0.05 | - |
| A2 | 0.86 | 0.86 | ± 0.09 | - |
| b | 0.33 | 0.23 | $+0.07/-0.08$ | - |
| c | 0.18 | 0.18 | ± 0.05 | - |
| D | 3.00 | 3.00 | ± 0.10 | 1, 3 |
| E | 4.90 | 4.90 | ± 0.15 | - |
| E1 | 3.00 | 3.00 | ± 0.10 | 2, 3 |
| e | 0.65 | 0.50 | Basic | - |
| L | 0.55 | 0.55 | ± 0.15 | - |
| L1 | 0.95 | 0.95 | Basic | - |
| N | 8 | 10 | Reference | - |

Rev. C 6/99

NOTES:

1. Plastic or metal protrusions of 0.15mm maximum per side are not included.
2. Plastic interlead protrusions of 0.25mm maximum per side are not included.
3. Dimensions "D" and "E1" are measured at Datum Plane "H".
4. Dimensioning and tolerancing per ASME Y14.5M-1994.

EL5102, EL5103, EL5202, EL5203, EL5302

Small Outline Package Family (SO)

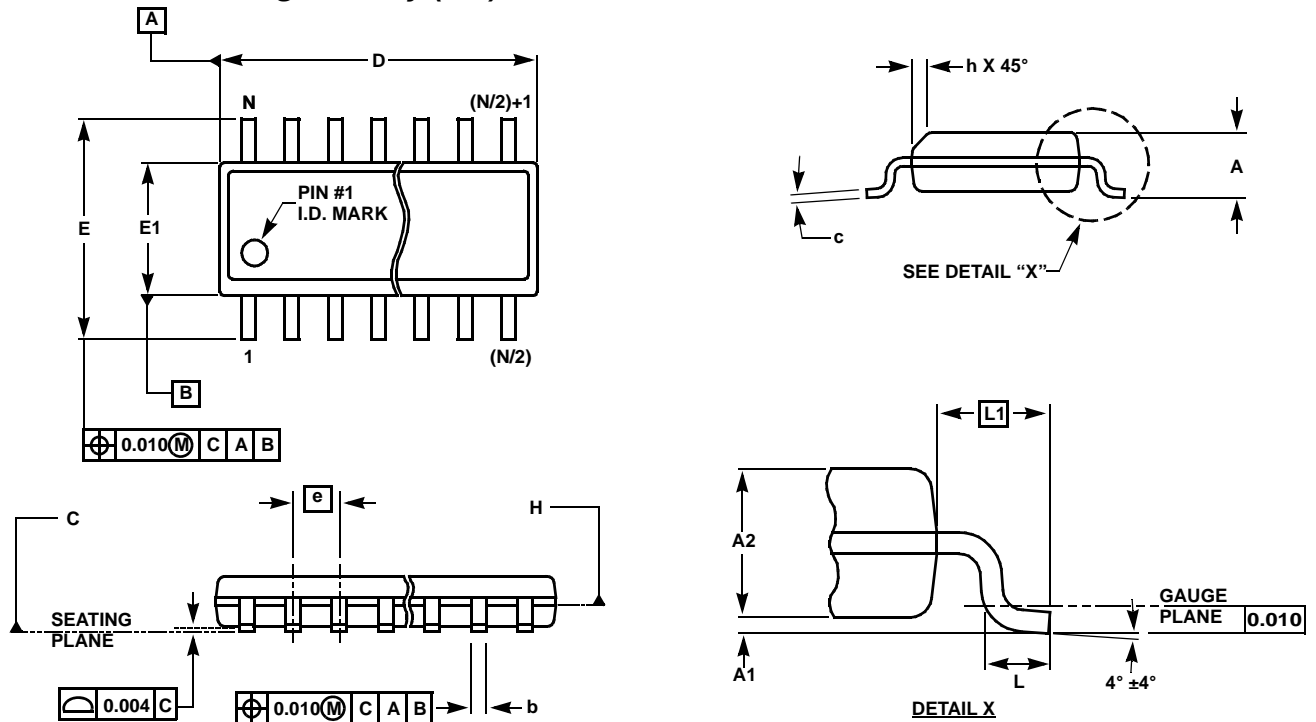

MDP0027

SMALL OUTLINE PACKAGE FAMILY (SO)

| SYMBOL | SO-8 | SO-14 | SO16 (0.150") | SO16 (0.300") (SOL-16) | SO20 (SOL-20) | SO24 (SOL-24) | SO28 (SOL-28) | TOLERANCE | NOTES |
|--------|-------|-------|------------------|---------------------------|------------------|------------------|------------------|-------------|-------|
| A | 0.068 | 0.068 | 0.068 | 0.104 | 0.104 | 0.104 | 0.104 | MAX | - |
| A1 | 0.006 | 0.006 | 0.006 | 0.007 | 0.007 | 0.007 | 0.007 | ± 0.003 | - |
| A2 | 0.057 | 0.057 | 0.057 | 0.092 | 0.092 | 0.092 | 0.092 | ± 0.002 | - |
| b | 0.017 | 0.017 | 0.017 | 0.017 | 0.017 | 0.017 | 0.017 | ± 0.003 | - |
| c | 0.009 | 0.009 | 0.009 | 0.011 | 0.011 | 0.011 | 0.011 | ± 0.001 | - |
| D | 0.193 | 0.341 | 0.390 | 0.406 | 0.504 | 0.606 | 0.704 | ± 0.004 | 1, 3 |
| E | 0.236 | 0.236 | 0.236 | 0.406 | 0.406 | 0.406 | 0.406 | ± 0.008 | - |
| E1 | 0.154 | 0.154 | 0.154 | 0.295 | 0.295 | 0.295 | 0.295 | ± 0.004 | 2, 3 |
| e | 0.050 | 0.050 | 0.050 | 0.050 | 0.050 | 0.050 | 0.050 | Basic | - |
| L | 0.025 | 0.025 | 0.025 | 0.030 | 0.030 | 0.030 | 0.030 | ± 0.009 | - |
| L1 | 0.041 | 0.041 | 0.041 | 0.056 | 0.056 | 0.056 | 0.056 | Basic | - |
| h | 0.013 | 0.013 | 0.013 | 0.020 | 0.020 | 0.020 | 0.020 | Reference | - |
| N | 8 | 14 | 16 | 16 | 20 | 24 | 28 | Reference | - |

Rev. L 2/01

NOTES:

1. Plastic or metal protrusions of 0.006" maximum per side are not included.
2. Plastic interlead protrusions of 0.010" maximum per side are not included.
3. Dimensions "D" and "E1" are measured at Datum Plane "H".
4. Dimensioning and tolerancing per ASME Y14.5M-1994

Small Outline Transistor Plastic Packages (SC70-5)

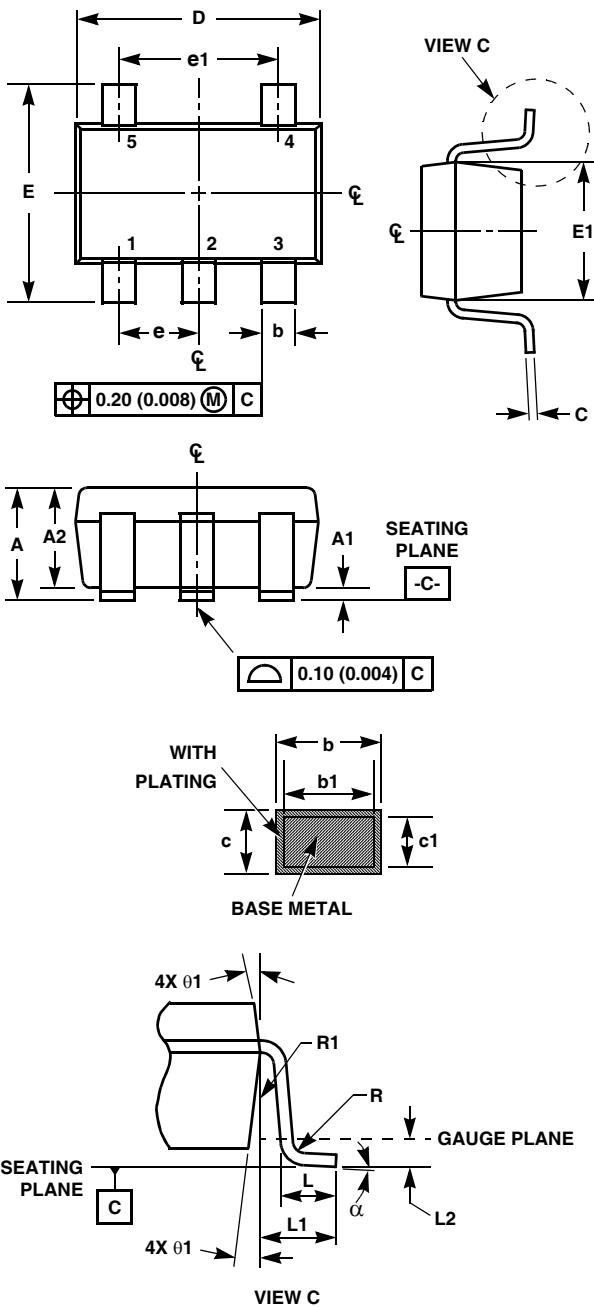

P5.049

5 LEAD SMALL OUTLINE TRANSISTOR PLASTIC PACKAGE

| SYMBOL | INCHES | | MILLIMETERS | | NOTES |
|--------|------------|-------|-------------|------|-------|
| | MIN | MAX | MIN | MAX | |
| A | 0.031 | 0.043 | 0.80 | 1.10 | - |
| A1 | 0.000 | 0.004 | 0.00 | 0.10 | - |
| A2 | 0.031 | 0.039 | 0.80 | 1.00 | - |
| b | 0.006 | 0.012 | 0.15 | 0.30 | - |
| b1 | 0.006 | 0.010 | 0.15 | 0.25 | - |
| c | 0.003 | 0.009 | 0.08 | 0.22 | 6 |
| c1 | 0.003 | 0.009 | 0.08 | 0.20 | 6 |
| D | 0.073 | 0.085 | 1.85 | 2.15 | 3 |
| E | 0.071 | 0.094 | 1.80 | 2.40 | - |
| E1 | 0.045 | 0.053 | 1.15 | 1.35 | 3 |
| e | 0.0256 Ref | | 0.65 Ref | | - |
| e1 | 0.0512 Ref | | 1.30 Ref | | - |
| L | 0.010 | 0.018 | 0.26 | 0.46 | 4 |
| L1 | 0.017 Ref. | | 0.420 Ref. | | - |
| L2 | 0.006 BSC | | 0.15 BSC | | - |
| α | 0° | 8° | 0° | 8° | - |
| N | 5 | | 5 | | 5 |
| R | 0.004 | - | 0.10 | - | - |
| R1 | 0.004 | 0.010 | 0.15 | 0.25 | - |

Rev. 2 9/03

NOTES:

1. Dimensioning and tolerances per ASME Y14.5M-1994.
2. Package conforms to EIAJ SC70 and JEDEC MO-203AA.
3. Dimensions D and E1 are exclusive of mold flash, protrusions, or gate burrs.
4. Footlength L measured at reference to gauge plane.
5. "N" is the number of terminal positions.
6. These Dimensions apply to the flat section of the lead between 0.08mm and 0.15mm from the lead tip.
7. Controlling dimension: MILLIMETER. Converted inch dimensions are for reference only.

All Intersil U.S. products are manufactured, assembled and tested utilizing ISO9000 quality systems. Intersil Corporation's quality certifications can be viewed at www.intersil.com/design/quality

Intersil products are sold by description only. Intersil Corporation reserves the right to make changes in circuit design, software and/or specifications at any time without notice. Accordingly, the reader is cautioned to verify that data sheets are current before placing orders. Information furnished by Intersil is believed to be accurate and reliable. However, no responsibility is assumed by Intersil or its subsidiaries for its use; nor for any infringements of patents or other rights of third parties which may result from its use. No license is granted by implication or otherwise under any patent or patent rights of Intersil or its subsidiaries.

For information regarding Intersil Corporation and its products, see www.intersil.com