

# Compact PLC Series CPM2C

## General

The CPM2C Micro PLC is suitable as a controller for simple stand-alone machines, as well as a simple networked controller. One innovation is the new synchronisation instruction, which makes it possible to generate output pulse trains as a function of an input pulse frequency, e.g. to emulate the synchronisation of 2 axes through a variable gear ratio. Furthermore, PID control and pulse width modulation can also be realised easily by preconfigured instructions.

PLC programs from the CPM1/CPM1A and the CPM2A can be used with the CPM2C. Programming is carried out using the CX-Programming software.

Features of the CPM2C series:

- Small size, space-saving narrow design
- Removable terminal block or connector
- Real-time clock and backup battery (dependent on type)
- One 20 kHz counter and two 10 kHz pulse outputs
- Peripheral and RS-232C ports in one connector
- Active RS-232C port (RXD/TXD instruction)
- Synchronisation, PID control, and pulse width modulation instructions

The very small size and DIN rack mounting allow the CPM2C to be installed in small control cabinets, which can be integrated directly into machines and therefore save a great deal of space.



## Performance Data (Max. Values)

		CPM2C-10_	CPM2C-S1_	CPM2C-20_	CPM2C-32_
<b>Built-in I/O</b>	<b>Inputs</b>	6	6	12	16
	<b>Outputs</b>	4	4	8	16
<b>With expansion</b>	<b>Inputs</b>	86	54	92	96
	<b>Outputs</b>	84	52	88	96
<b>Execution time (bit instruction)</b>		0.64 µs	0.64 µs	0.64 µs	0.64 µs
<b>Program memory</b>		4 kwords	4 kwords	4 kwords	4 kwords
<b>Data memory</b>		2 kwords	2 kwords	2 kwords	2 kwords
<b>Input interrupts</b>		2	2	4	4
<b>Time-controlled interrupts</b>		1	1	1	1

## Networks and Communication

<b>Ethernet (open network)</b>	-	-	-	-
<b>Controller Link (PLC network)</b>	-	-	-	-
<b>Host Link, SYSMAC WAY (serial network)</b>	Yes	Yes	Yes	Yes
<b>DeviceNet (open fieldbus)</b>	-	Yes (slave)	-	-
<b>CompoBus/S (fieldbus)</b>	Yes (slave)	Yes (master/slave)	Yes (slave)	Yes (slave)
<b>AS-Interface (open fieldbus)</b>	-	-	-	-
<b>PROFIBUS-DP (open fieldbus)</b>	-	-	-	-

# Compact PLC Series CPM2C

## System Configuration

### Configuration

The individual Units of the CPM2C system are plugged in to one another and secured using 2 locking sliders. The system must be mounted on DIN rail.

### Communication interfaces

The CPM2C has one peripheral and one RS-232C interface on a miniature peripheral socket. They can both be accessed via the CPM2C-CN111 adapter cable.

For other adapter cables, see page 61.

Both ports can be used simultaneously.

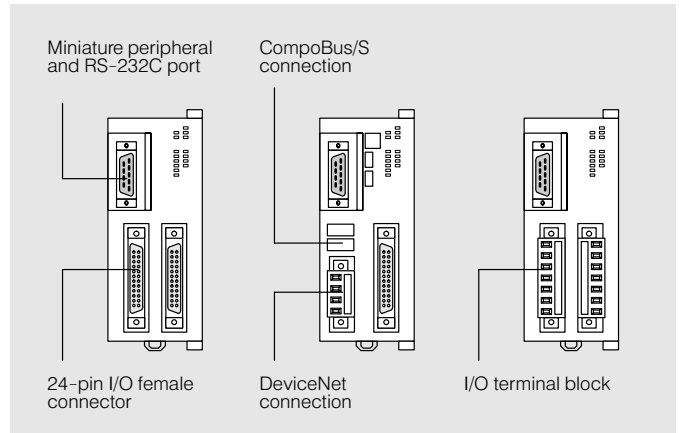

### Expansion of the CPM2C

Up to five Expansion Units can be connected to CPM2C CPU Units, and up to three Expansion Units to CPM2C-S100C/S110C Units. Only a total of four of the CPM2C-MAD11 and CPM2C-TS\_ Expansion Units can be connected.

### Interrupt input

Two or four of the normal transistor inputs can also be configured as interrupt inputs. Various interrupt modes are available.

### Pulse outputs

Only CPM2C CPU Units with transistor outputs provide a pulse output function. These pulse outputs are to be subtracted from the number of available standard outputs.

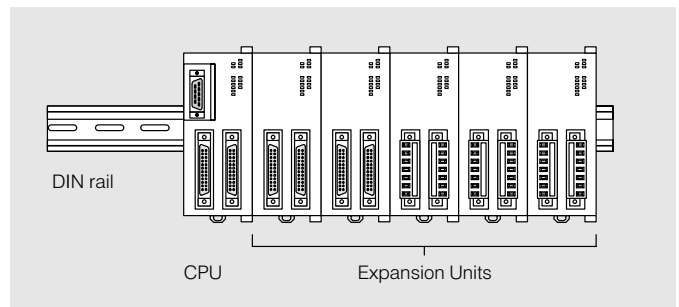

### High-speed counter inputs

If the high-speed counter function is required, three of the normal transistor inputs are occupied. The high-speed counter input can be used to connect an encoder with phases A, B and Z, for example.

#### - Differential phase mode

The maximum input frequency is 5 kHz.

Each upward and each downward edge is counted, i.e. at 5 kHz, 20,000 pulses per second are counted.

The Z phase can be used as a reset signal.

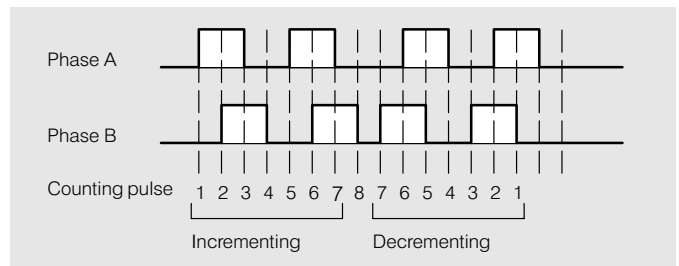

#### - Pulse/direction mode

The maximum counting frequency is 20 kHz.

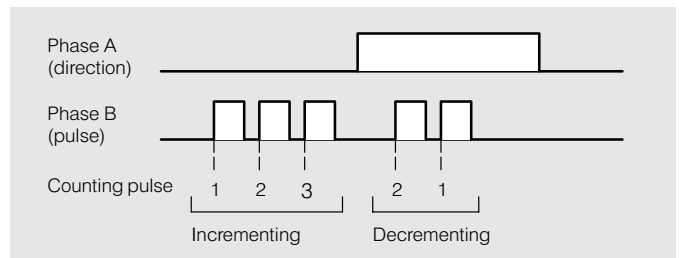

#### - Up/down count mode

The maximum counting frequency is 20 kHz.

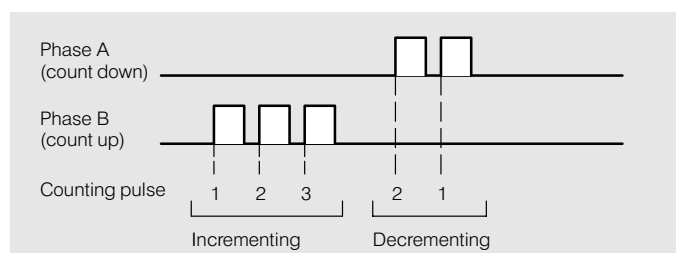

# Compact PLC Series CPM2C

## CPU Units



- CPM2C-CPU Unit**
- DIN rail mounting
  - LED status display
  - Max. 5 Expansion Units
  - Removable terminal blocks
  - Voltage supply 24 VDC

Model code	CPM2C-10CDR-D
Inputs	6 DC inputs
Outputs	4, relay
Data backup	Capacitor
Real-time clock	-



Model code	CPM2C-10C1DR-D
Inputs	6 DC inputs
Outputs	4, relay
Data backup	Battery
Real-time clock	Yes

Model code	CPM2C-20CDR-D
Inputs	12 DC inputs
Outputs	8, relay
Data backup	Capacitor
Real-time clock	-

Model code	CPM2C-20C1DR-D
Inputs	12 DC inputs
Outputs	8, relay
Data backup	Battery
Real-time clock	Yes



- CPM2C-CPU Unit**
- DIN rail mounting
  - LED status display
  - Max. 5 Expansion Units
  - 24-pin front connector\*
  - Voltage supply 24 VDC
  - Pulse output
  - FUJITSU connector

Model code	CPM2C-10CDT1C-D
Inputs	6 DC inputs
Outputs	4, transistor, PNP
Data backup	Capacitor
Real-time clock	-

Model code	CPM2C-10CDTC-D
Inputs	6 DC inputs
Outputs	4, transistor, NPN
Data backup	Capacitor
Real-time clock	-

Model code	CPM2C-10C1DT1C-D
Inputs	6 DC inputs
Outputs	4, transistor, PNP
Data backup	Battery
Real-time clock	Yes

Model code	CPM2C-10C1DTC-D
Inputs	6 DC inputs
Outputs	4, transistor, NPN
Data backup	Battery
Real-time clock	Yes

\* Front connector or terminal block and cable are not included in delivery package, see page 465.

# Compact PLC Series CPM2C

## CPU Units (Continued)



### CPM2C-CPU Unit

- DIN rail mounting
- LED status display
- Max. 5 Expansion Units
- 24-pin front connector\*
- Voltage supply 24 VDC
- Pulse output
- MIL connector

<b>Model code</b>	<b>CPM2C-10CDT1M-D</b>
Inputs	6 DC inputs
Outputs	4, transistor, PNP
Data backup	Capacitor
Real-time clock	-
<b>Model code</b>	<b>CPM2C-10CDTM-D</b>
Inputs	6 DC inputs
Outputs	4, transistor, NPN
Data backup	Capacitor
Real-time clock	-
<b>Model code</b>	<b>CPM2C-10C1DT1M-D</b>
Inputs	6 DC inputs
Outputs	4, transistor, PNP
Data backup	Battery
Real-time clock	Yes
<b>Model code</b>	<b>CPM2C-10C1DTM-D</b>
Inputs	6 DC inputs
Outputs	4, transistor, NPN
Data backup	Battery
Real-time clock	Yes

\* Front connector or terminal block and cable are not included in delivery package, see page 465.

# Compact PLC Series CPM2C

## CPU Units (Continued)



- CPM2C-CPU Unit**
- DIN rail mounting
  - LED status display
  - Max. 5 Expansion Units
  - 24-pin front connector\*
  - Voltage supply 24 VDC
  - Pulse output
  - FUJITSU connector



<b>Model code</b>	<b>CPM2C-20CDT1C-D</b>
Inputs	12 DC inputs
Outputs	8, transistor, PNP
Data backup	Capacitor
Real-time clock	-
<b>Model code</b>	<b>CPM2C-20CDTC-D</b>
Inputs	12 DC inputs
Outputs	8, transistor, NPN
Data backup	Capacitor
Real-time clock	-
<b>Model code</b>	<b>CPM2C-20C1DT1C-D</b>
Inputs	12 DC inputs
Outputs	8, transistor, PNP
Data backup	Battery
Real-time clock	Yes
<b>Model code</b>	<b>CPM2C-20C1DTC-D</b>
Inputs	12 DC inputs
Outputs	8, transistor, NPN
Data backup	Battery
Real-time clock	Yes
<b>Model code</b>	<b>CPM2C-32CDT1C-D</b>
Inputs	16 DC inputs
Outputs	16, transistor, PNP
Data backup	Capacitor
Real-time clock	-
<b>Model code</b>	<b>CPM2C-32CDTC-D</b>
Inputs	16 DC inputs
Outputs	16, transistor, NPN
Data backup	Capacitor
Real-time clock	-

\* Front connector or terminal block and cable are not included in delivery package, see page 465.

# Compact PLC Series CPM2C

## CPU Units (Continued)



- CPM2C-CPU Unit**
- DIN rail mounting
  - LED status display
  - Max. 5 Expansion Units
  - 24-pin front connector\*
  - Voltage supply 24 VDC
  - Pulse output
  - MIL connector

Model code	CPM2C-20CDT1M-D
Inputs	12 DC inputs
Outputs	8, transistor, PNP
Data backup	Capacitor
Real-time clock	-

Model code	CPM2C-20CDTM-D
Inputs	12 DC inputs
Outputs	8, transistor, NPN
Data backup	Capacitor
Real-time clock	-

Model code	CPM2C-20C1DT1M-D
Inputs	12 DC inputs
Outputs	8, transistor, PNP
Data backup	Battery
Real-time clock	Yes

Model code	CPM2C-20C1DTM-D
Inputs	12 DC inputs
Outputs	8, transistor, NPN
Data backup	Battery
Real-time clock	Yes

Model code	CPM2C-32CDT1M-D
Inputs	16 DC inputs
Outputs	16, transistor, PNP
Data backup	Capacitor
Real-time clock	-

Model code	CPM2C-32CDTM-D
Inputs	16 DC inputs
Outputs	16, transistor, NPN
Data backup	Capacitor
Real-time clock	-



- CPM2C-CPU Unit**
- DIN rail mounting
  - LED status display
  - Max. 3 Expansion Units
  - 24-pin front connector\*
  - Voltage supply 24 VDC
  - Pulse output
  - FUJITSU connector

Model code	CPM2C-S110C
Inputs	6 DC inputs
Outputs	4, transistor, PNP
CompoBus/S Master	Up to 128 remote input points + 128 remote output points
Data backup	Battery
Real-time clock	Yes

Model code	CPM2C-S100C
Inputs	6 DC inputs
Outputs	4, transistor, NPN
CompoBus/S Master	Up to 128 remote input points + 128 remote output points
Data backup	Battery
Real-time clock	Yes



\* Front connector or terminal block and cable are not included in delivery package, see page 465.

# Compact PLC Series CPM2C

## CPU Units (Continued)



- CPM2C-CPU Unit**
- DIN rail mounting
  - LED status display
  - Max. 3 Expansion Units
  - 24-pin front connector\*
  - Voltage supply 24 VDC
  - Pulse output 2
  - FUJITSU connector

Model code	CPM2C-S110C-DRT
Inputs	6 DC inputs 1 circuit, 6 inputs
Outputs	4 transistor, PNP 1 circuit, 4 outputs
DeviceNet I/O Link	Configurable up to 64 byte in + 64 byte out
CompoBus/S Master	Up to 128 remote input points + 128 remote output points
Data backup	Battery
Real-time clock	Yes

- CPM2C-CPU Unit**
- DIN rail mounting
  - LED status display
  - Max. 3 Expansion Units
  - 24-pin front connector\*
  - Voltage supply 24 VDC
  - Pulse output

Model code	CPM2C-S100C-DRT
Inputs	6 DC inputs 1 circuit, 6 inputs
Outputs	4, transistor, NPN 1 circuit, 4 outputs
DeviceNet I/O Link	Configurable, up to 64 byte in + 64 byte out
CompoBus/S Master	Up to 128 remote input points + 128 remote output points
Data backup	Battery
Real-time clock	Yes

\* Front connector or terminal block and cable are not included in delivery package, see page 465.

## Specifications

Relay output	CPM2C	-10CDR-D	-10C1DR-D	-	-
Transistor outp. PNP		-	-	-10CDT1C/M-D	-10C1DT1C/M-D
Transistor outp. NPN		-	-	-10CDTC/M-D	-10C1DTC/M-D
CPU built-in inputs		6 DC inp. 1 circuit, 6 inp.	6 DC inp. 1 circuit, 6 inp.	6 DC inp. 1 circuit, 6 inp.	6 DC inp. 1 circuit, 6 inp.
CPU built-in outputs		4 relay outp. 2 circuits, 1 outp. each 1 circuit, 2 outp. 4 A per circuit	4 relay outp. 2 circuits, 1 outp. each 1 circuit, 2 outp. 4 A per circuit	4 transistor outp. 1 circuit, 4 outp. 1 circuit, 2 outp. 1.2 A per circuit	4 transistor outp. 1 circuit, 4 outp. 1 circuit, 2 outp. 1.2 A per circuit
Max. local	Inputs Outputs	86 84	86 84	86 84	86 84
Real-time clock		-	Yes	-	Yes
Number of Expansion Units		5	5	5	5
Data backup		Capacitor, 10 days	Battery, 2 years	Capacitor, 10 days	Battery, 2 years
Pulse output 10 Hz..10 kHz		-	-	2	2
Input interrupts 300 µs call subroutine		2	2	2	2
Counter interrupts 2 kHz counting frequency		2	2	2	2
Pulse storage min. 50 µs pulse width		2	2	2	2

# Compact PLC Series CPM2C

## Specifications (Continued)

<b>Relay output</b>	<b>CPM2C</b>	<b>-20CDR-D</b>	<b>-20C1DR-D</b>	<b>-</b>	<b>-</b>
<b>Transistor outp. PNP</b>		-	-	<b>-20CDT1C/M-D</b>	<b>-20C1DT1C/M-D</b>
<b>Transistor outp. NPN</b>		-	-	<b>-20CDTC/M-D</b>	<b>-20C1DTC/M-D</b>
CPU built-in inputs		12 DC inp. 1 circuit, 12 inp.	12 DC inp. 1 circuit, 12 inp.	12 DC inp. 1 circuit, 8 inp. 1 circuit, 4 inp.	12 DC inp. 1 circuit, 8 inp. 1 circuit, 4 inp.
CPU built-in outputs		8 relay outp. 4 circuits, 2 outp. each 4 A per circuit	8 relay outp. 4 circuits, 2 outp. each 4 A per circuit	8 transistor outp. 1 circuits, 8 outp. 2.4 A per circuit	8 transistor outp. 1 circuits, 8 outp. 2.4 A per circuit
Max. local	Inputs Outputs	92 88	92 88	92 88	92 88
Real-time clock		-	Yes	-	Yes
Number of Expansion Units		5	5	5	5
Data backup		Capacitor, 10 days	Battery, 2 years	Capacitor, 10 days	Battery, 2 years
Pulse output 10 Hz..10 kHz		-	-	2	2
Input interrupts 300 µs call subroutine		4	4	4	4
Counter interrupts 2 kHz counting frequency		4	4	4	4
Pulse storage min. 50 µs pulse width		4	4	4	4
<b>Relay output</b>	<b>CPM2C</b>	<b>-</b>	<b>-</b>	<b>-</b>	<b>-</b>
<b>Transistor outp. PNP</b>		<b>-32CDT1C/M-D</b>	<b>-S110C</b>	<b>-S110C-DRT</b>	
<b>Transistor outp. NPN</b>		<b>-32CDTC/M-D</b>	<b>-S100C</b>	<b>-S100C-DRT</b>	
CPU built-in inputs		16 DC inp. 2 circuit, 8 inp.	6 DC inp. 1 circuit, 4 inp. 1 circuit, 2 inp.	6 DC inp. 1 circuit, 4 inp. 1 circuit, 2 inp.	
CPU built-in outputs		16 transistor outp. 2 circuits, 8 outp. each* 3.2 A per circuit	4 transistor outp. 1 circuit, 4 outp. 1.2 A per circuit	4 transistor outp. 1 circuit, 4 outp. 1.2 A per circuit	
Max. local	Inputs Outputs	96 96	54 52	54 52	
CompoBus/S max. remote	Inputs Outputs	- -	128 128	128 128	
DeviceNet max. Link	Inputs Outputs	- -	- -	64 bytes 64 bytes	
Real-time clock		-	Yes	Yes	
Number of Expansion Units		5	3	3	
Data backup		Capacitor, 10 days	Battery, 2 years	Battery, 2 years	
Pulse output 10 Hz..10 kHz		2	2	2	
Input interrupts 300 µs call subroutine		4	2	2	
Counter interrupts 2 kHz counting frequency		4	2	2	
Pulse storage min. 50 µs pulse width		4	2	2	

\* Output switching capacity differs depending on the circuit



# Compact PLC Series CPM2C

## Specifications (Continued)

Time-controlled interrupts 0.5 ms..5 min	1
Execution time            μs	0.64
Program memory        kwords	4
Data memory            kwords	2
Work relay                bits (words)	928 (58)
Holding relay            bits (words)	320 (20)
Timer/Counter	256 (1 ms, 10 ms, 100 ms, 1/10 s, timer, counter)
CPU ports	1 miniature peripheral port, comprising - 1 RS-232C port - 1 RS-232C port/programming console (switchable)
Number of instructions	14 basic instructions, 106 special instructions, all with edge- or level-triggered execution
Special instructions	<ul style="list-style-type: none"> <li>- Synchronisation                - PID                                - Pulse width modulation</li> <li>- Pulse output                    - Macro                            - 7 segment decoder</li> <li>- Subroutine                      - ASCII/HEX                      - Tabular processing</li> <li>- Arithmetic                      - Indirect addressing</li> </ul>
Program backup	Flash EEPROM
Program protection	Password
Pulse counter	1x 20 kHz single-phase or 5 kHz differential mode (encoder phases A, B and Z)
Supply voltage	24 VDC
Operating voltage limits	20.4..26.4 VDC
Power consumption	3..4 W, + 1..2 W per Expansion Unit (except CPM2C-MAD11: 3.5 W)
Insulation resistance	Min. 20 MΩ at 500 VDC, measured between AC and PE terminal
Dielectric strength	2300 VAC at 50/60 Hz for one minute with a leakage current of max. 10 mA between AC and PE terminals.
Noise immunity	2 kV on power lines, conforms to IEC 61000-4-4
Vibration resistance	10..57 Hz with 0.075 mm amplitude; 57..0.150 Hz with an acceleration of 1 G in X, Y and Z directions, 10 sweeps of 8 minutes each.
Shock resistance	147 m/s <sup>2</sup> (15 G) in X, Y and Z directions 3 times each.
Temperature            Operation Storage	0..55 °C -20..75 °C
Ambient humidity	10..90% (without condensation)
Atmosphere	System must not be exposed to the following conditions: <ul style="list-style-type: none"> <li>- Corrosive gases</li> <li>- Severe temperature fluctuations</li> <li>- Air with an extreme dust or salt content</li> <li>- Metal filings or metallic dust</li> <li>- Splash water or other chemicals</li> </ul>
Degree of protection	IEC IP30 (Control cabinet mounting)
Grounding	According to EN60204
Approvals	CE, UL, CSA

Data words, Holding relays, Auxiliary relays and counter values are backed up by a built-in battery for up to 5 years. In models without built-in battery this data is backed up by a built-in capacitor for up to 10 days.

# Compact PLC Series CPM2C

## Specifications (Continued)

### DC inputs of CPU Units

The inputs IN0000..IN0001 are the fast counter inputs (e.g. encoder phase A and B).

Input voltage	ON level OFF level	24 VDC (20.4..26.4 VDC) Min. 14.4 VDC Max. 5.0 VDC
Input impedance		3.9..4.7 kΩ (IN0000..IN0001: 2.7 kΩ)
Input current		5..6 mA (IN0000..IN0001: 8 mA)
ON/OFF delay		10 ms (selectable in 8 steps from 1..80 ms)

### Relay outputs of CPU Units

Type of output		Relay
Max. switching capacity		250 VAC, 2 A (cosφ=1); 24 VDC, 2 A
Min. switching capacity		5 VDC, 10 mA
Relay life	electrical mechanical	150,000 operations at R load, 100,000 operations at L load 20,000,000 operations
ON/OFF delay		Max. 15 ms

### Transistor outputs of CPU Units

Type of output		Transistor
Switching capacity		24 V (20.4..26.4 V), 0.3 A for first set of 8 24 V (20.4..26.4 V), 0.1 A for second set of 8
Leakage current		Max. 0.1 mA
Residual voltage		Max. 0.8 V
ON delay		Max. 0.1 ms (pulse outputs 20 μs)
OFF delay		Max. 1 ms (pulse outputs 40 μs at >10mA)

## Power Supplies



<b>Power supply unit</b> - Power supply for CPM2A and CPM2C series	<b>Model code</b>	<b>CPM2C-PA201</b>
	Input voltage	100..240 VAC
	Output voltage	24 VDC, 600 mA (14.4W)

## Port Adapters



	Description	Cable length	Model code
<b>RS-232C port adapter</b>	Adapter unit for connection to the peripheral port of the CPM2C-CPU - 1x peripheral port (RS-232C possible via CS1W-CN226) - 1x RS-232C	7 cm	<b>CPM2C-CIF01-V1</b>
<b>RS-232C and RS-422/485 port adapter</b>	Adapter unit for connection to the peripheral port of the CPM2C-CPU - 1x RS-422/485 - 1x RS-232C	7 cm	<b>CPM2C-CIF11</b>
<b>RS-232C and RS-422/485 communication adapter</b> For device connection overview, see page 61	Adapter unit for connection to the peripheral port of the CPM2C-CPU - 1x RS-422/485 - 1x RS-232C - Communication protocol for CompoWay/F, SYSWAY, NT-Link - Communication programs for OMRON timers, counters, controllers and multi-function displays	7 cm	<b>CPM2C-CIF21</b>

# Compact PLC Series CPM2C

## Connection and Adapter Cables

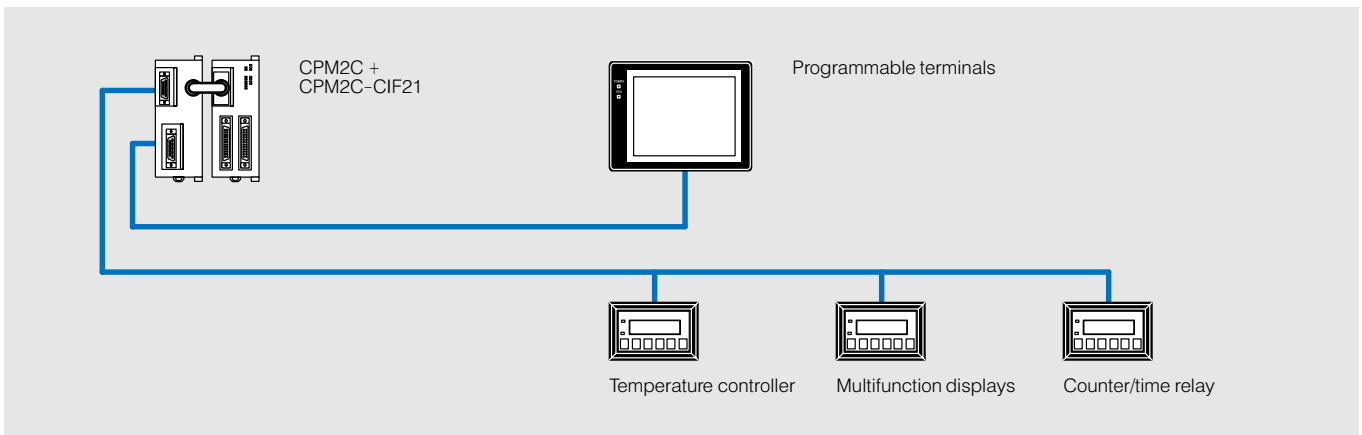

### Device connection overview for CPM2C with CIF21

	Type	SYSWAY	CompoWay/F
<b>Temperature controller</b>	E5AN, E5CN, E5EN, E5GN	Yes	Yes
	E5ZN	No	Yes
	E5AK, E5CK, E5EK	Yes	No
	E5AK-T, E5CK-T, E5EK-T	No	No
	E5AJ, E5EJ	Yes	No
	E5AF	Yes	No
<b>Timer</b>	H8GN	No	Yes
<b>Multifunction displays</b>	K3GN	No	Yes
	K3NX	Yes	Limited
	K3NV	Yes	Limited
	K3NR	Yes	Limited
	K3NP	Yes	Limited
	K3NC	Yes	Limited
	K3NH	Yes	Limited
	K3TS	Yes	No

## Programming, Accessories and Documentation

### Programming



Description	Cable length	Model code
<b>CX-Programmer.</b> PLC programming software. For WINDOWS 95/98/ME/2000/NT4.0-SP5/XP - see page 434	-	<b>WS02-CXPC1-__</b>
Programming cable, peripheral port <-> PC	2 m	<b>CS1W-CN226</b>
	6 m	<b>CS1W-CN626</b>
Programming consoles	2 m	<b>CQM1H-PRO01-E</b>
	-	<b>C200H-PRO27-E</b>
Cable for PRO27 to CPU	2 m	<b>CS1W-CN224</b>
Cable for PRO27 to CPU	6 m	<b>CS1W-CN624</b>

# Compact PLC Series CPM2C



## Programming, Accessories and Documentation (Continued)



Program copy device	Writing of the user program, the PLC configuration, the expanded instruction set and the data words from DM6144 to DM6655 on EEPROM, as well as downloading of EEPROM data in the PLC. For PLC systems: CPM and CQM1H Supported EEPROMs: Atmel AT28C256 NEC μPD28C256 <b>* CPM2C–CN111 or –CN114 adapter cables must be used</b>	20 cm	<b>CPM1–EMU01–V1*</b>
24-pin connector for the CPM2C Units with plug connection (solder terminal)		–	<b>C500–CE241</b>
24-pin connector for the CPM2C Units with plug connection (spring clip for ribbon cable)		–	<b>C500–CE243</b>
Spare battery for CPM2C		–	<b>CPM2C–BAT01</b>
Spare cable for 24 VDC power supply for CPM2C		0.1 m	<b>Power cable CPM2C</b>

Accessories, cables etc.

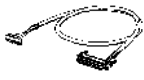
### Terminal blocks and connecting cable for connector types, CPU and Expansion Units

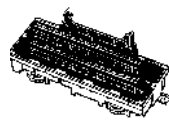
PLC/Unit	Connecting cables	Cable length	Terminal block	Description	
CPM2C–20C CPM2C–24E CPM2C–32C CPM2C–32E		<b>XW2Z–050A</b>	0.5 m		<b>XW2B–20G4</b> – 20 inputs or outputs – Screw terminals M3
		<b>XW2Z–100A</b>	1.0 m		
		<b>XW2Z–200A</b>	2.0 m		
		<b>XW2Z–500A</b>	5.0 m		
<b>MIL connector</b> CPM2C–20C_M CPM2C–24E_M CPM2C–32CM CPM2C–32EM		<b>G79–O25C</b>	0.25 m		<b>XW2B–20G4</b> – 20 inputs or outputs – Screw terminals M3
		<b>G79–O50C</b>	0.50 m		

For terminal block terminal assignment, see page 465.

Technical Documentation

English documentation	Product	Title	Model code
	CPM2C	Operation Manual	<b>W356–E1</b>
	CPM1/CPM1A/CPM2A/ CPM2C/SRM1(–V2)	Programming Manual	<b>W353–E1</b>
	CPM2C–S_	Operation Manual	<b>W377–E1</b>

# Compact PLC Series CPM2C

## Terminal Blocks, Connection and Adapter Cables

### Adapter cable for communications

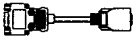
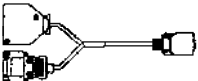
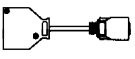
	Adapter cable	Description	Cable length	Model code
	Adapter cable	Connection between miniature peripheral port and RS-232C port, D-sub, 9-pin	0.1 m	<b>CS1W-CN118</b>
	Y adapter cable	Connection between miniature peripheral port and RS-232C port, D-sub, 9-pin <b>and</b> peripheral port with large connector	0.2 m	<b>CPM2C-CN111</b>
	Adapter cable	Connection between miniature peripheral port and peripheral port with large connector	0.1 m	<b>CS1W-CN114</b>

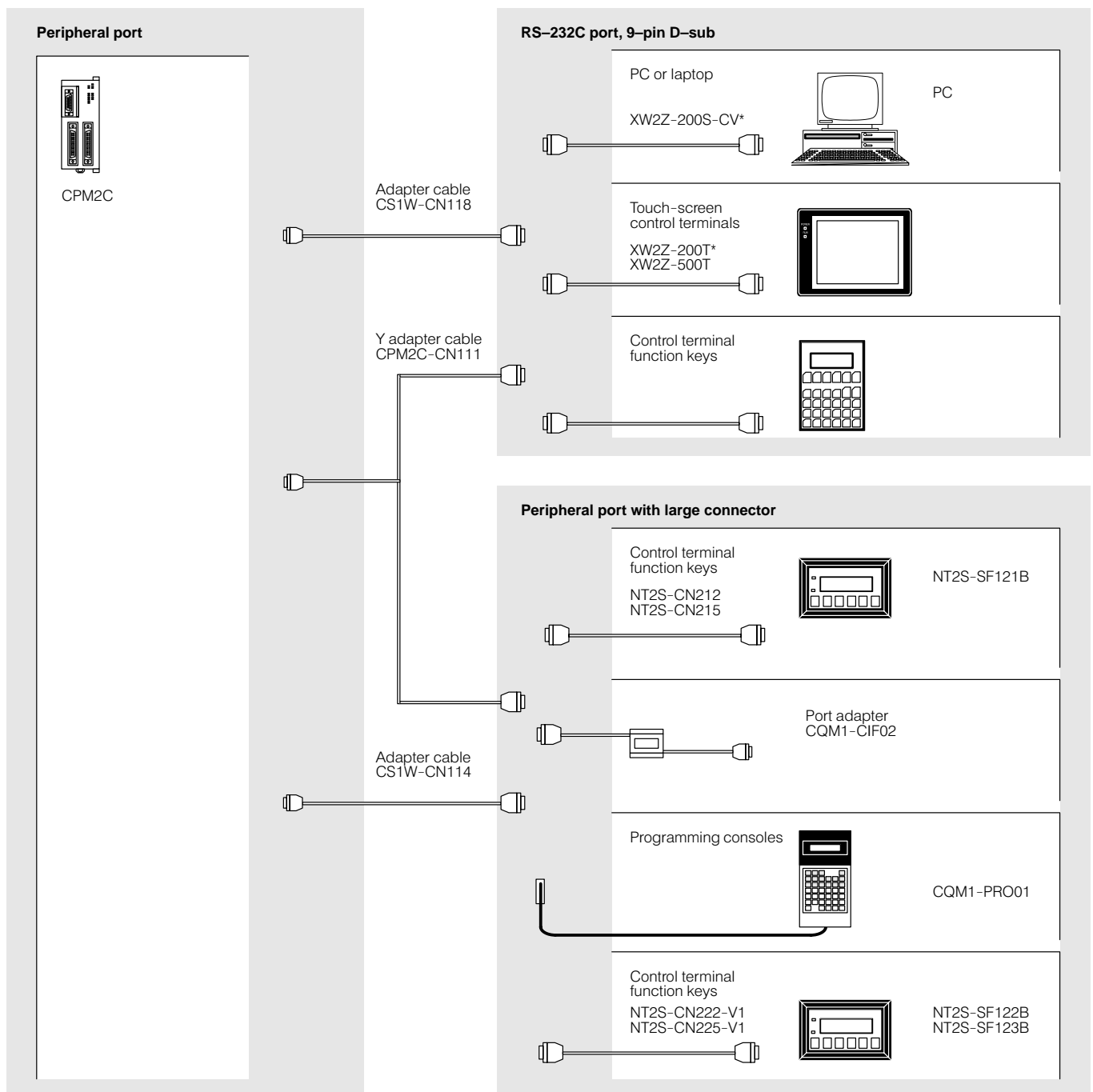

\* Please compare these articles with the selection available in your country.

# Compact PLC Series CPM2C

## Terminal Blocks, Connection and Adapter Cables (Continued)

### Peripheral port or peripheral port and RS-232C

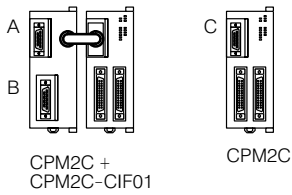

### RS-232C port, 9-pin D-sub

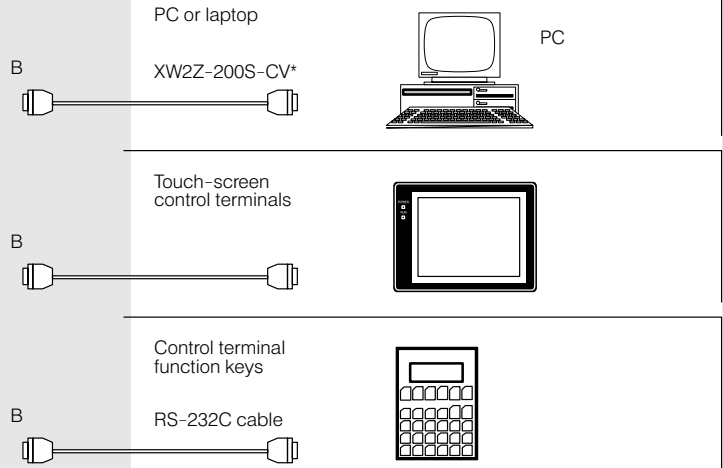

### Peripheral port with DDK connector

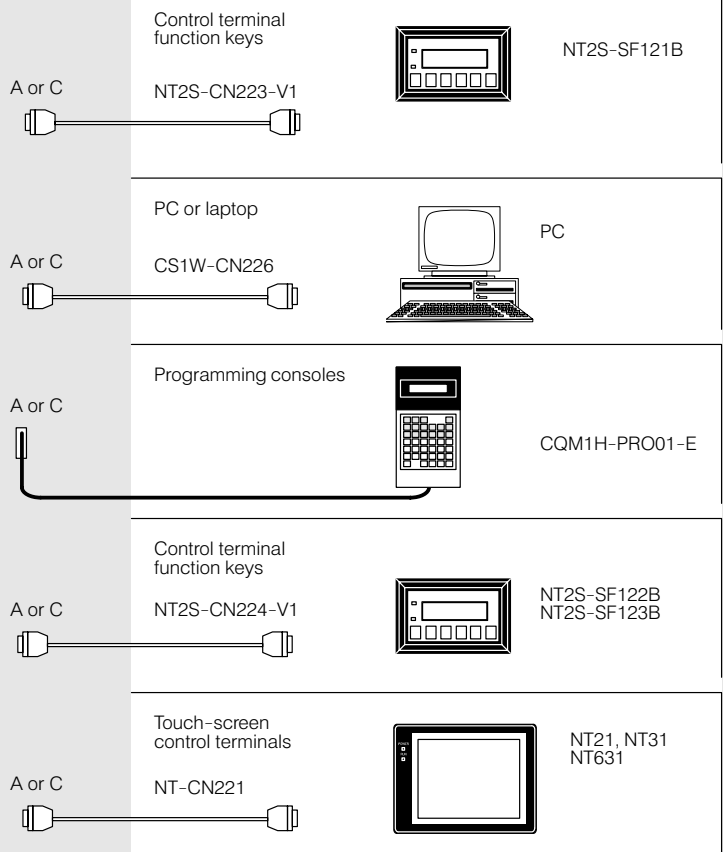

\* Please compare these articles with the selection available in your country.

# Compact PLC Series CPM2C

## Dimensions (mm)

### CPU

Product	W
CPM2C-10C(1)DR/-20C(1)DR	33
CPM2C-10C(1)DT_/-20C(1)DT_/-32C(1)DT_	33
CPM2C-S1_OC(-DRT)	40

### Expansion Unit

CPM2C-8ER/-10EDR/-20EDR	33
CPM2C-24EDT_/-32EDT_	33
CPM2C-8EDC/-8ET_/-16EDC/-16ET_	20
CPM2C-MAD11	33
CPM2C-TS_	33
CPM2C-SRT	20

### Communication adapter

CPM2C-CIF_	33
------------	----

### Power supply

CPM2C-PA201	40
-------------	----

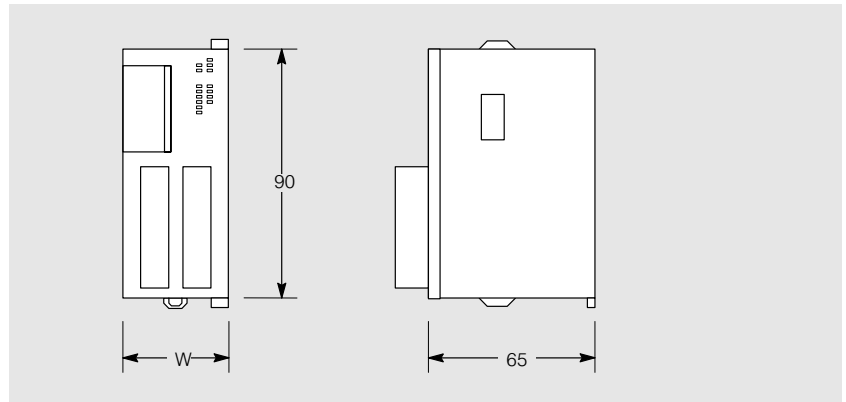

## Communication Examples

	CPM2C
<b>SYSMAC WAY (network)</b>	Yes
<b>Active RS-232C</b>	Yes
<b>1:1 CPU Link</b>	Yes
<b>1:1 NT Link</b>	Yes

### SYSMAC WAY

SYSMAC WAY communicates via RS-232C and RS-422 ports and contains the disclosed and OMRON-specific ASCII protocol called the HostLink. By default, the CPM2C communication port runs in Host Link slave mode and can therefore be easily operated from a PC, a supervisory controller or HMI.

Up to 32 Host Link slaves can be integrated into a SYSMAC WAY network via RS-422 ports.

	<p><b>RS-232C port:</b></p> <p>CS1W-CN226</p>	<p>PC</p>
<p>CPM2C + CPM2C-CIF11</p>	<p>RS-422 cable</p>	<p>CS1 + CS1W-SCB41</p> <p>CJ1H + CJ1W-SCU41</p> <p>CPM2C + CPM2C-CIF11</p>

# Compact PLC Series CPM2C

## Communication Examples (Continued)

### Active RS-232C

The CPM2C's RS-232C port can be switched to active RS-232C mode by the Host Link slave. SEND and RECEIVE instructions can be used to send and receive ASCII character strings. Peripherals such as modems, printers or barcode readers can be integrated.

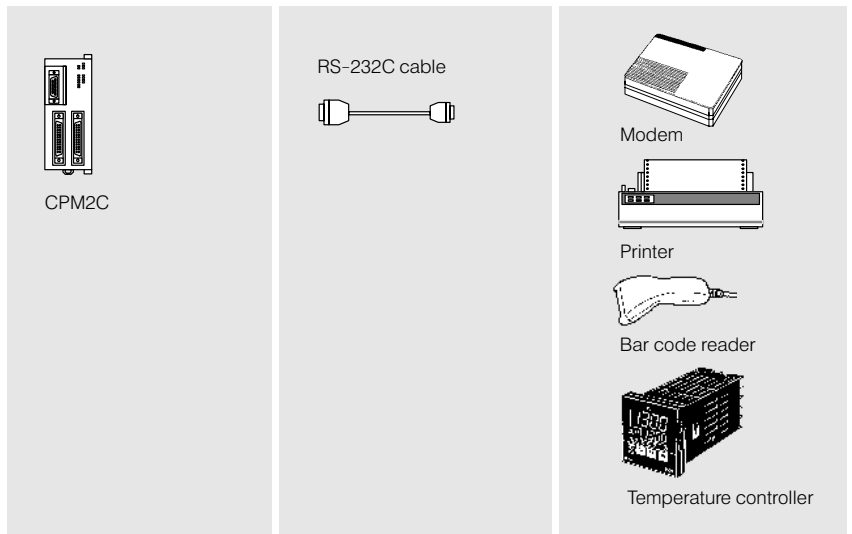

### 1:1 CPU Link

Via the 1:1 CPU Link, up to 64 words can be continuously exchanged between two PLC CPU Units without any programming effort, by means of a peripheral or RS-232C port.

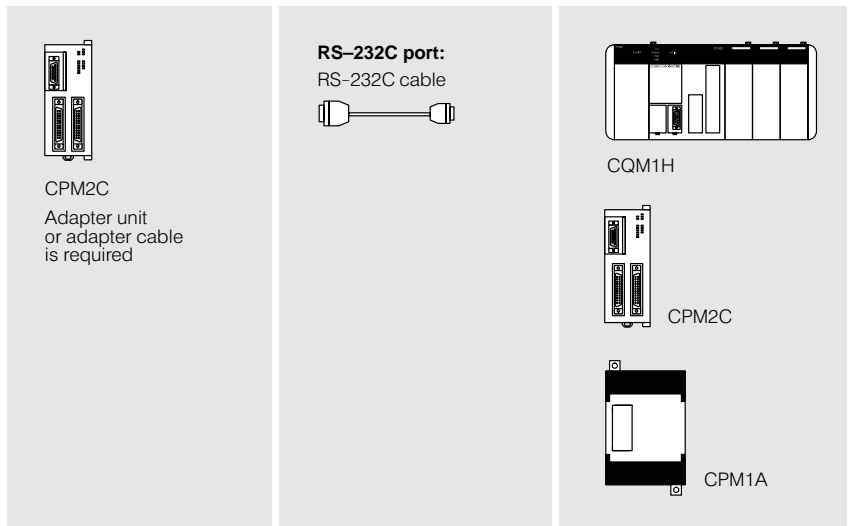

### 1:1 NT Link

Various control terminals, from function keys to NT/NS-series touch-screen colour terminals, are available to the user as a man/machine interface. Data is exchanged very quickly between a control terminal and the PLC via the 1:1 NT Link protocol.

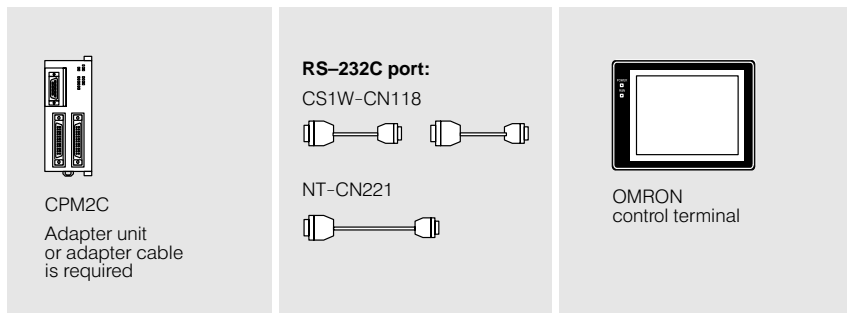









# Compact PLC Series CPM2C

## Expansion Units

	I/O type	Description	Connection	Model code	Page
<b>Digital I/O Expansion Units</b>	8 DC inputs	24 VDC	FUJITSU connector	<b>CPM2C-8EDC</b>	66
	8 DC inputs	24 VDC	MIL connector	<b>CPM2C-8EDM</b>	
	8 relay outputs	250 VAC, 2 A	Terminal connection	<b>CPM2C-8ER</b>	66
	8 transistor outputs	PNP, 24 VDC, 0.3 A	FUJITSU connector	<b>CPM2C-8ET1C</b>	66
	8 transistor outputs	PNP, 24 VDC, 0.3 A	MIL connector	<b>CPM2C-8ET1M</b>	
	8 transistor outputs	NPN, 24 VDC, 0.3 A	FUJITSU connector	<b>CPM2C-8ETC</b>	66
	8 transistor outputs	NPN, 24 VDC, 0.3 A	MIL connector	<b>CPM2C-8ETM</b>	
	6 DC inputs and 4 relay outputs	24 VDC 250 VAC, 2 A	Terminal connection	<b>CPM2C-10EDR</b>	66
	16 DC inputs	24 VDC	FUJITSU connector	<b>CPM2C-16EDC</b>	66
	16 DC inputs	24 VDC	MIL connector	<b>CPM2C-16EDM</b>	
	16 transistor outputs	PNP, 24 VDC, 0.3 A	FUJITSU connector	<b>CPM2C-16ET1C</b>	66
	16 transistor outputs	PNP, 24 VDC, 0.3 A	MIL connector	<b>CPM2C-16ET1M</b>	
	16 transistor outputs	NPN, 24 VDC, 0.3 A	FUJITSU connector	<b>CPM2C-16ETC</b>	66
	16 transistor outputs	NPN, 24 VDC, 0.3 A	MIL connector	<b>CPM2C-16ETM</b>	
	12 DC inputs and 8 relay outputs	24 VDC 250 VAC, 2 A	Terminal connection	<b>CPM2C-20EDR</b>	66
	16 DC inputs and 8 transistor outputs	24 VDC PNP, 24 VDC, 0.3 A	FUJITSU connector	<b>CPM2C-24EDT1C</b>	67
	16 DC inputs and 8 transistor outputs	24 VDC PNP, 24 VDC, 0.3 A	MIL connector	<b>CPM2C-24EDT1M</b>	
	16 DC inputs and 8 transistor outputs	24 VDC NPN, 24 VDC, 0.3 A	FUJITSU connector	<b>CPM2C-24EDTC</b>	67
	16 DC inputs and 8 transistor outputs	24 VDC NPN, 24 VDC, 0.3 A	MIL connector	<b>CPM2C-24EDTM</b>	
	16 DC inputs and 16 transistor outputs	24 VDC PNP, 24 VDC, 0.3 A	FUJITSU connector	<b>CPM2C-32EDT1C</b>	67
	16 DC inputs and 16 transistor outputs	24 VDC PNP, 24 VDC, 0.3 A	MIL connector	<b>CPM2C-32EDT1M</b>	
	16 DC inputs and 16 transistor outputs	24 VDC NPN, 24 VDC, 0.3 A	FUJITSU connector	<b>CPM2C-32EDTC</b>	67
	16 DC inputs and 16 transistor outputs	24 VDC NPN, 24 VDC, 0.3 A	MIL connector	<b>CPM2C-32EDTM</b>	
2 inputs 1 output	0..20 mA, -10..10 V 0..20 mA, -10..10 V	Terminal connection	<b>CPM2C-MAD11</b>	68	
2 inputs	Thermocouple	Terminal connection	<b>CPM2C-TS001</b>	68	
2 inputs	Pt100	Terminal connection	<b>CPM2C-TS101</b>	68	
<b>CompoBus/S I/O Link Unit</b>	8 input bits 8 output bits	Fieldbus slave	Terminal connection	<b>CPM2C-SRT21</b>	68

# Compact PLC Series CPM2C

## Expansion Units (Continued)

	<b>Digital I/O Expansion Units</b> - LED status display - DIN rail mounting - 24-pin front connector*	<b>Model code</b>	<b>CPM2C-8EDC CPM2C-8EDM</b>		
		Inputs	8 DC inputs 1 circuit, 8 inputs		
	<b>Digital I/O Expansion Units</b> - LED status display - DIN rail mounting - Removable terminal blocks	<b>Model code</b>	<b>CPM2C-8ER</b>		
		Outputs	8, relays 4 circuits, 1 output each 2 circuits, 2 outputs each		
		Total switching capacity	4 A per circuit		
	<b>Digital I/O Expansion Units</b> - LED status display - DIN rail mounting - 24-pin front connector*	<b>Model code</b>	<b>CPM2C-8ET1C CPM2C-8ET1M</b>		
		Outputs	8, transistor, PNP 1 circuit, 8 outputs		
		Total switching capacity	2.4 A per circuit		
		<b>Model code</b>	<b>CPM2C-8ETC CPM2C-8ETM</b>		
		Outputs	8, transistor, NPN 1 circuit, 8 outputs		
		Total switching capacity	2.4 A per circuit		
	<b>Digital I/O Expansion Units</b> - LED status display - DIN rail mounting - Removable terminal blocks	<b>Model code</b>	<b>CPM2C-10EDR</b>		
		Inputs	6 DC inputs 1 circuit, 6 inputs		
		Outputs	4, relays 1 circuit, 2 outputs		
		Total switching capacity	4A per circuit		
	<b>Digital I/O Expansion Units</b> - LED status display - DIN rail mounting - 24-pin front connector*	<b>Model code</b>	<b>CPM2C-16EDC CPM2C-16EDM</b>		
		Inputs	16 DC inputs 2 circuits, 8 inputs each		
		<b>Model code</b>	<b>CPM2C-16ET1C CPM2C-16ET1M</b>		
		Outputs	16, transistor, PNP 2 circuits, 8 outputs each		
		Total switching capacity	3.2 A per circuit		
		<b>Model code</b>	<b>CPM2C-16ETC CPM2C-16ETM</b>		
		Outputs	16, transistor, NPN 2 circuits, 8 outputs each		
		Total switching capacity	3.2 A per circuit		
			<b>Digital I/O Expansion Units</b> - LED status display - DIN rail mounting - Removable terminal blocks	<b>Model code</b>	<b>CPM2C-20EDR</b>
				Inputs	12 DC inputs 1 circuit, 12 inputs
Outputs	8, relays 4 circuit, 2 outputs				
Total switching capacity	4 A per circuit				

\* Front connector or terminal block and cable are not included in delivery package, see page 465.

# Compact PLC Series CPM2C

## Expansion Units (Continued)



<b>Digital I/O Expansion Units</b> - LED status display - DIN rail mounting - 24-pin front connector*	<b>Model code</b>	<b>CPM2C-24EDT1C</b> <b>CPM2C-24EDT1M</b>
	Inputs	16 DC inputs 2 circuits, 8 inputs each
	Outputs	8, transistor, PNP 1 circuit, 8 outputs
	Total switching capacity	2.4 A per circuit



<b>Digital I/O Expansion Units</b> - LED status display - DIN rail mounting - 24-pin front connector*	<b>Model code</b>	<b>CPM2C-24EDTC</b> <b>CPM2C-24EDTM</b>
	Inputs	16 DC inputs 2 circuits, 8 inputs each
	Outputs**	8, transistor, NPN 1 circuit, 8 outputs
	Total switching capacity	2.4 A per circuit

<b>Digital I/O Expansion Units</b> - LED status display - DIN rail mounting - 24-pin front connector*	<b>Model code</b>	<b>CPM2C-32EDT1C</b> <b>CPM2C-32EDT1M</b>
	Inputs	16 DC inputs 2 circuits, 8 inputs each
	Outputs	16, transistor, PNP 2 circuits, 8 outputs each
	Total switching capacity	3.2 A per circuit

	<b>Model code</b>	<b>CPM2C-32EDTC</b> <b>CPM2C-32EDTM</b>
	Inputs	16 DC inputs 2 circuits, 8 inputs each
	Outputs**	16, transistor, NPN 2 circuits, 8 outputs each
	Total switching capacity	3.2 A per circuit

<b>Specification for DC inputs</b>	Circuitry	PNP/NPN logic
	Input voltage	24 VDC (20.4..26.4 VDC) Min. 14.4 VDC Max. 5.0 VDC
	ON level	
	OFF level	
	Input impedance	4.7 kΩ
	Input current	5 mA

<b>Specification for relay outputs</b>	Switching capacity	250 VAC, 2A (cosφ=1); 24 VDC, 2 A 5 VDC, 10 mA
	Relay life	150,000 operations at R load 100,000 operations at L load 20,000,000 operations
	electrical	
	mechanical	
ON/OFF delay		Max. 15 ms

<b>Specification for transistor outputs</b>	Switching capacity	1st circuit 2nd circuit	24 VDC (20.4..26.4 VDC), 0.3 A 24 VDC (20.4..26.4 VDC), 0.1 A
	Leakage current		Max. 0.1 mA
	Residual voltage		Max. 1.5 V
	ON delay		Max. 0.2 ms
	OFF delay		Max. 1 ms

\* Front connector or terminal block and cable are not included in delivery package, see page 465.

\*\* Output switching capacity differs depending on the circuit.

# Compact PLC Series CPM2C

## Expansion Units (Continued)



### Analogue I/O Expansion Unit

- Maximum 4 Units per CPU
- Automatic averaging
- LED status display
- Removable terminal blocks

<b>Model code</b>		<b>CPM2C-MAD11</b>
Number of analogue I/O		2 inputs 1 output
Range per input	Voltage Current	0..5 V, 1..5 V, 0..10 V, -10..10 V 0..20 mA, 4..20 mA
Input resistance	Voltage Current	1 M $\Omega$ 250 $\Omega$
Range of outputs	Voltage Current	1..5 V, 0..10 V, -10..10 V 0..20 mA, 4..20 mA
Resolution		1/6000
Accuracy		0.4% of full scale
Conversion time		6 ms overall
Potential isolation		Photocoupler



### Temperature sensor Expansion Units

- Maximum 4 Units per CPU
- LED status display
- Removable terminal block

<b>Model code</b>		<b>CPM2C-TS001</b>
Number of inputs		2 inputs, thermocouple
Sensor types		K (Ni/Cr) J (Fe/constantan)
Measuring range		-200..1300 °C, 0..500°C -100..850 °C, 0..400°C
Accuracy		±0.5% or 2°C ±1 digit
Conversion time		250 ms (total)
<b>Model code</b>		<b>CPM2C-TS101</b>
Number of inputs		2 inputs, Pt100
Sensor types		Pt100, JPt100
Measuring range		-200..650 °C
Accuracy		±0.5% or 1°C ±1 digit
Conversion time		250 ms (total)



### CompoBus/S I/O Link Unit

- LED status display
  - Removable terminal block
- For further information about CompoBus/S, see page 256.

<b>Model code</b>		<b>CPM2C-SRT21</b>
Number of Link bits	Input Output	8 bits 8 bits