

STANDARD RECOVERY DIODES

Hockey Puk Version

Features

- Wide current range
- High voltage ratings up to 3000V
- High surge current capabilities
- Diffused junction
- Hockey Puk version
- Case style DO-200AB (B-PUK)

Typical Applications

- Converters
- Power supplies
- Machine tool controls
- High power drives
- Medium traction applications

1600A

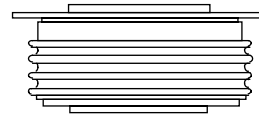

case style DO-200AB (B-PUK)

Major Ratings and Characteristics

Parameters	SD1500C..L	Units	
$I_{F(AV)}$	1600	A	
@ T_{hs}	55	°C	
$I_{F(RMS)}$	3010	A	
@ T_{hs}	25	°C	
I_{FSM}	@ 50Hz	16600	A
	@ 60Hz	17400	A
I^2t	@ 50Hz	1386	KA ² s
	@ 60Hz	1265	KA ² s
V_{RRM} range	400 to 3000	V	
T_J	- 40 to 180	°C	

SD1500C..L Series

Bulletin I2086 rev. B 04/00

International
 Rectifier

ELECTRICAL SPECIFICATIONS

Voltage Ratings

Type number	Voltage Code	V_{RRM} , maximum repetitive peak reverse voltage V	V_{RSM} , maximum non-repetitive peak rev. voltage V	I_{RRM} max. @ $T_J = T_J$ max. mA
SD1500C..L	04	400	500	50
	08	800	900	
	12	1200	1300	
	16	1600	1700	
	20	2000	2100	
	25	2500	2600	
	30	3000	3100	

Forward Conduction

Parameter	SD1500C..L	Units	Conditions
$I_{F(AV)}$ Max. average forward current @ Heatsink temperature	1600(820)	A	180° conduction, half sine wave
	55(85)	°C	Double side (single side) cooled
$I_{F(RMS)}$ Max. RMS forward current	3010	A	@ 25°C heatsink temperature double side cooled
I_{FSM} Max. peak, one-cycle forward, non-repetitive surge current	16600	A	t = 10ms No voltage reappplied
	17400		t = 8.3ms reappplied
	14000		t = 10ms 100% V_{RRM} reappplied
	14700		t = 8.3ms reappplied
I^2t Maximum I^2t for fusing	1386	KA ² s	t = 10ms No voltage reappplied
	1265		t = 8.3ms reappplied
	980		t = 10ms 100% V_{RRM} reappplied
	895		t = 8.3ms reappplied
$I^2\sqrt{t}$ Maximum $I^2\sqrt{t}$ for fusing	13860	KA ² /s	t = 0.1 to 10ms, no voltage reappplied
$V_{F(TO)1}$ Low level value of threshold voltage	0.83	V	$(16.7\% \times \pi \times I_{F(AV)} < I < \pi \times I_{F(AV)})$, $T_J = T_J$ max.
$V_{F(TO)2}$ High level value of threshold voltage	0.95		$(I > \pi \times I_{F(AV)})$, $T_J = T_J$ max.
r_{f1} Low level value of forward slope resistance	0.27	mΩ	$(16.7\% \times \pi \times I_{F(AV)} < I < \pi \times I_{F(AV)})$, $T_J = T_J$ max.
r_{f2} High level value of forward slope resistance	0.25		$(I > \pi \times I_{F(AV)})$, $T_J = T_J$ max.
V_{FM} Max. forward voltage drop	1.64	V	$I_{pk} = 3000A$, $T_J = T_J$ max, $t_p = 10ms$ sinusoidal wave

Thermal and Mechanical Specifications

Parameter	SD1500C..L	Units	Conditions
T _J Max. junction operating temperature range	-40 to 180	°C	
T _{stg} Max. storage temperature range	-55 to 200		
R _{thJ-hs} Max. thermal resistance, junction to heatsink	0.073 0.031	K/W	DC operation single side cooled DC operation double side cooled
F Mounting force, ± 10%	14700 (1500)	N (Kg)	
wt Approximate weight	255	g	
Case style	DO-200AB(B-PUK)		See Outline Table

ΔR_{thJ-hs} Conduction

(The following table shows the increment of thermal resistance R_{thJ-hs} when devices operate at different conduction angles than DC)

Conduction angle	Sinusoidal conduction		Rectangular conduction		Units	Conditions
	Single Side	Double Side	Single Side	Double Side		
180°	0.009	0.009	0.006	0.006	K/W	T _J = T _J max.
120°	0.011	0.011	0.011	0.011		
90°	0.014	0.014	0.015	0.015		
60°	0.020	0.020	0.021	0.021		
30°	0.035	0.035	0.036	0.036		

Ordering Information Table

Device Code

SD	150	0	C	30	L
①	②	③	④	⑤	⑥

- 1** - Diode
- 2** - Essential part number
- 3** - 0 = Standard recovery
- 4** - C = Ceramic Puk
- 5** - Voltage code: code x 100 = V_{RRM} (see Voltage Ratings Table)
- 6** - L = Puk Case DO-200AB (B-PUK)

SD1500C..L Series

Bulletin I2086 rev. B 04/00

International
IRF Rectifier

Outline Table

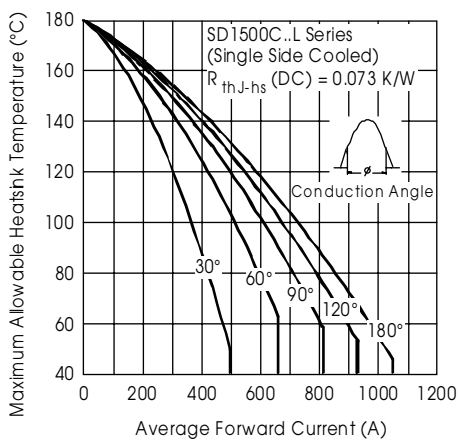
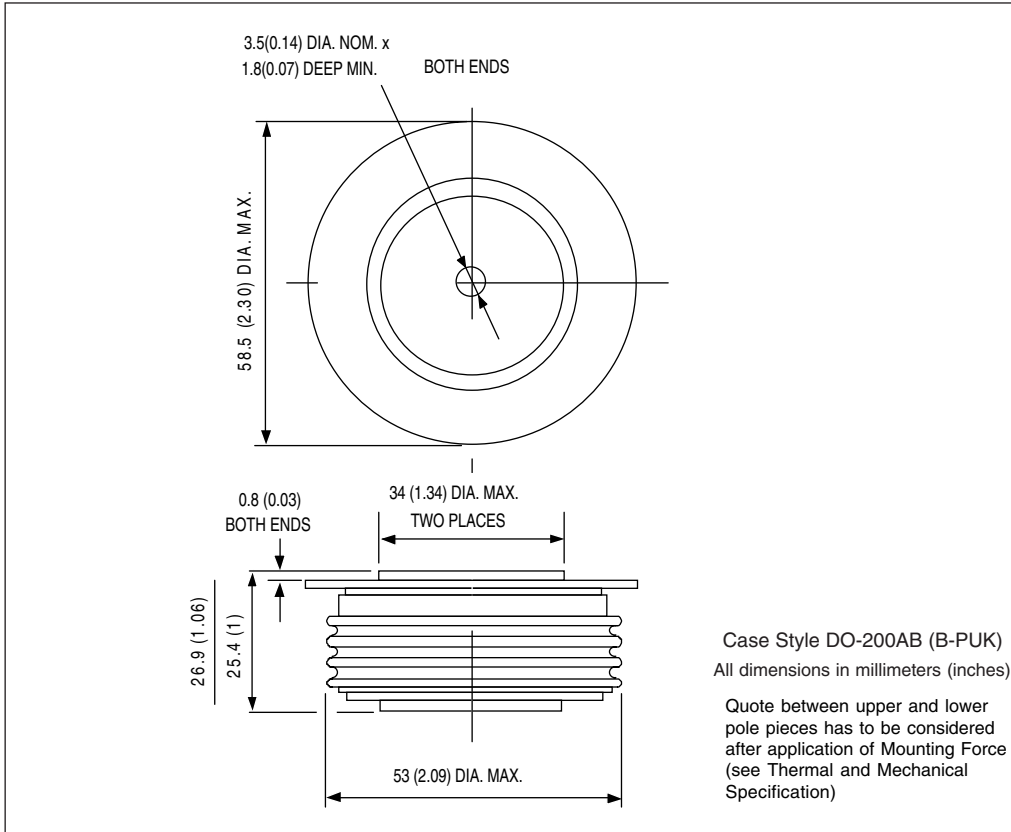

Fig. 1 - Current Ratings Characteristics

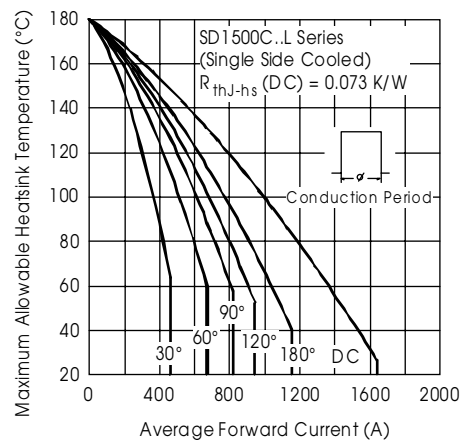

Fig. 2 - Current Ratings Characteristics

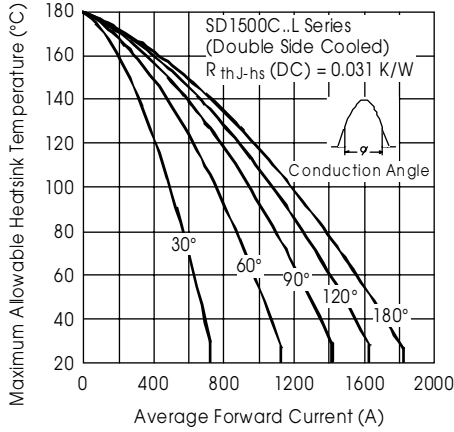

Fig. 3 - Current Ratings Characteristics

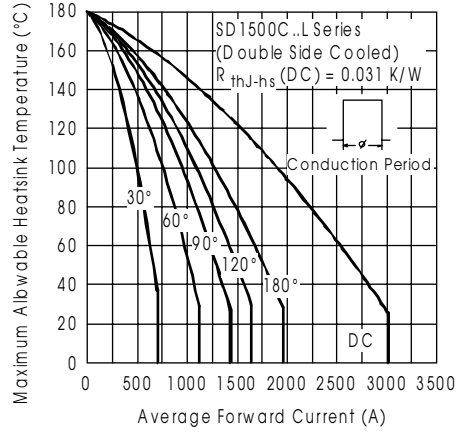

Fig. 4 - Current Ratings Characteristics

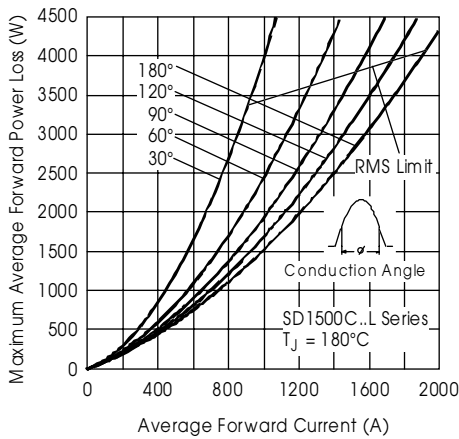

Fig. 5 - Forward Power Loss Characteristics

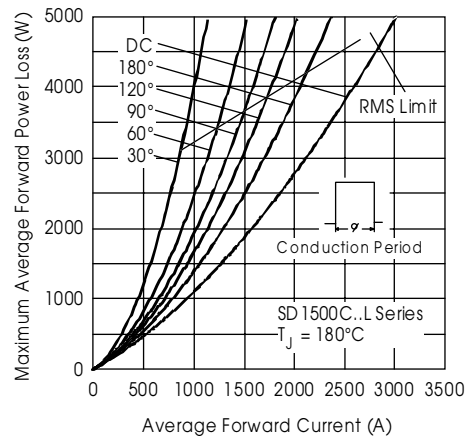

Fig. 6 - Forward Power Loss Characteristics

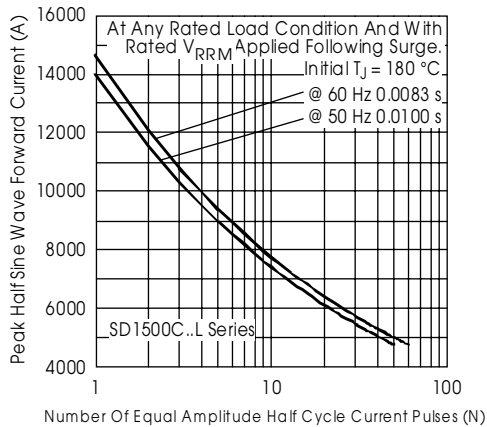

Fig. 7 - Maximum Non-Repetitive Surge Current
Single and Double Side Cooled

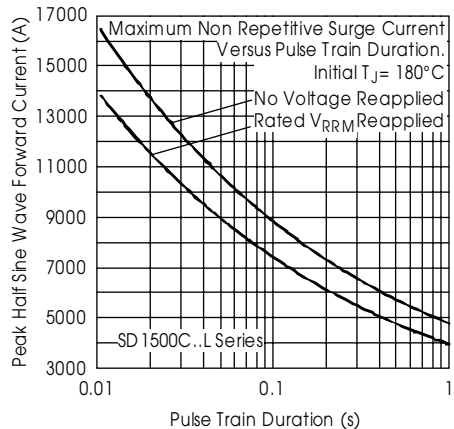

Fig. 8 - Maximum Non-Repetitive Surge Current
Single and Double Side Cooled

SD1500C..L Series

Bulletin I2086 rev. B 04/00

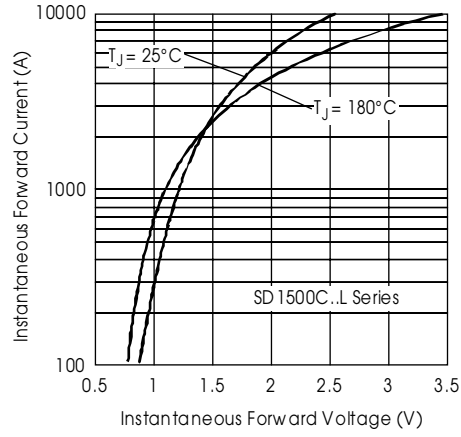

Fig. 9 - Forward Voltage Drop Characteristics

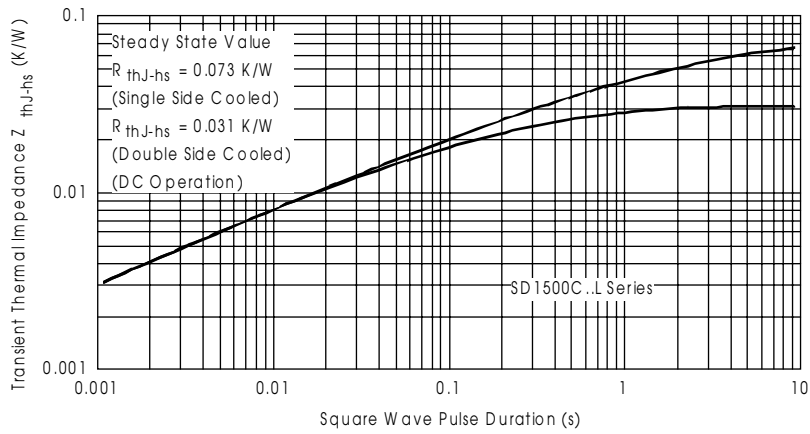

Fig. 10 - Thermal Impedance Z_{thJC} Characteristics