

## 5.0 A H-Bridge

The 33886 is a monolithic H-Bridge ideal for fractional horsepower DC-motor and bi-directional thrust solenoid control. The IC incorporates internal control logic, charge pump, gate drive, and low  $R_{DS(ON)}$  MOSFET output circuitry. The 33886 is able to control continuous inductive DC load currents up to 5.0 A. Output loads can be pulse width modulated (PWM-ed) at frequencies up to 10 kHz.

A Fault Status output reports undervoltage, short circuit, and overtemperature conditions. Two independent inputs control the two half-bridge totem-pole outputs. Two disable inputs force the H-Bridge outputs to tri-state (exhibit high impedance).

The 33886 is parametrically specified over a temperature range of  $-40^{\circ}\text{C} \leq T_A \leq 125^{\circ}\text{C}$ ,  $5.0\text{ V} \leq V^+ \leq 28\text{ V}$ . The IC can also be operated up to 40 V with derating of the specifications. The IC is available in a surface mount power package with exposed pad for heatsinking.

### Features

- Similar to the MC33186DH1 with Enhanced Features
- 5.0 V to 40 V Continuous Operation
- 120 m $\Omega$   $R_{DS(ON)}$  H-Bridge MOSFETs
- TTL/CMOS Compatible Inputs
- PWM Frequencies up to 10 kHz
- Active Current Limiting via Internal Constant OFF-Time PWM (with Temperature-Dependent Threshold Reduction)
- Output Short Circuit Protection
- Undervoltage Shutdown
- Fault Status Reporting
- Pb-Free Packaging Designated by Suffix Code VW

# 33886

## 5.0 A H-BRIDGE

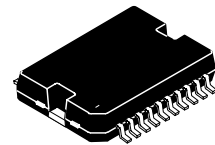

DH SUFFIX  
VW (Pb-FREE) SUFFIX  
CASE 979C-02  
20-TERMINAL HSOP

### ORDERING INFORMATION

Device	Temperature Range ( $T_A$ )	Package
MC33886DH/R2	-40°C to 125°C	20 HSOP
MC33886VW/R2		

33886 Simplified Application Diagram

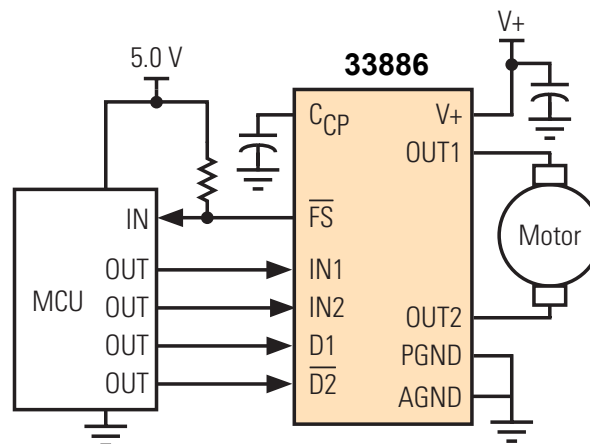

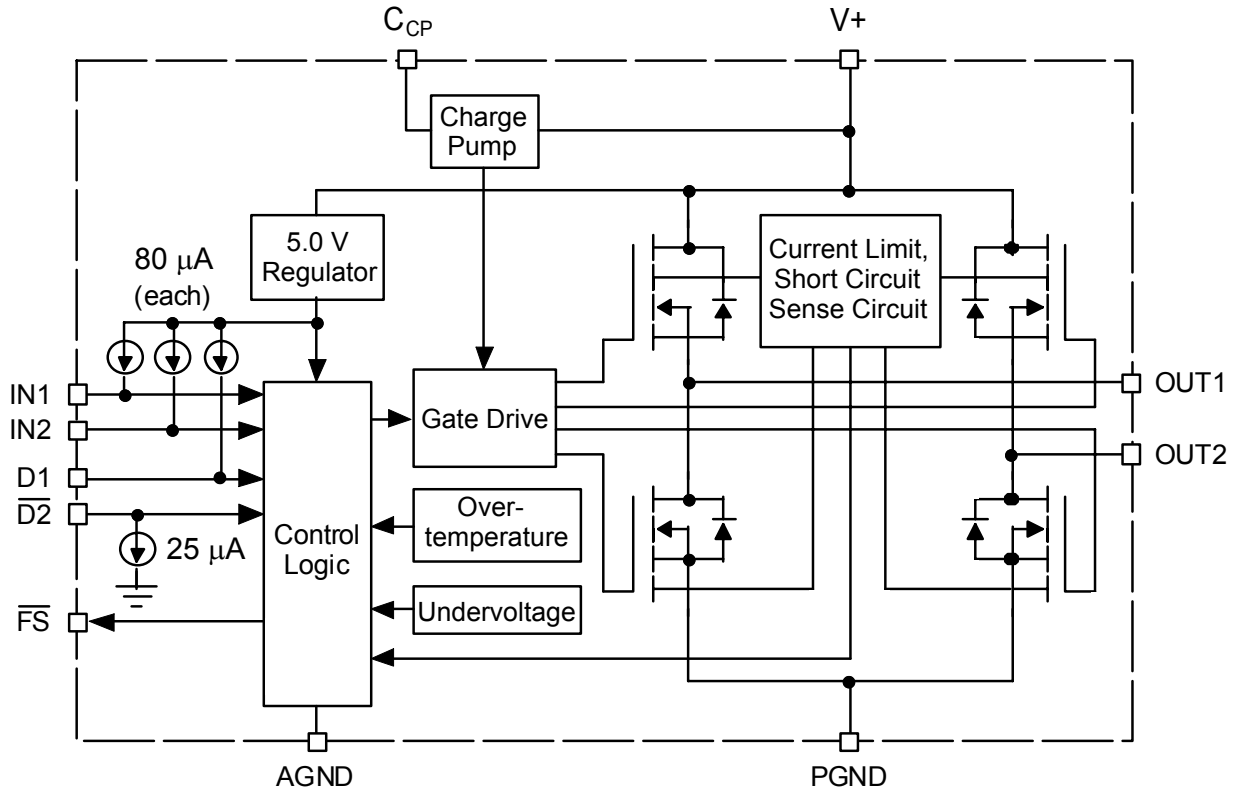
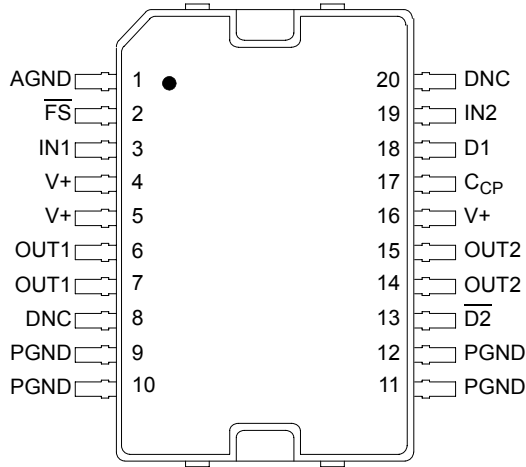

Figure 1. 33886 Simplified Internal Block Diagram



**TERMINAL FUNCTION DESCRIPTION**

Terminal	Terminal Name	Formal Name	Definition
1	AGND	Analog Ground	Low-current analog signal ground.
2	$\overline{FS}$	Fault Status for H-Bridge	Open drain active Low Fault Status output requiring a pull-up resistor to 5.0 V.
3	IN1	Logic Input Control 1	True logic input control of OUT1 (i.e., IN1 logic High = OUT1 logic High).
4, 5, 16	V+	Positive Power Supply	Positive supply connections.
6, 7	OUT1	H-Bridge Output 1	Output 1 of H-Bridge.
8, 20	DNC	Do Not Connect	Either do not connect (leave floating) or connect these terminals to ground in the application. They are test mode terminals used in manufacturing only.
9–12	PGND	Power Ground	Device high-current power ground.
13	$\overline{D2}$	Disable 2	Active Low input used to simultaneously tri-state disable both H-Bridge outputs. When $\overline{D2}$ is logic Low, both outputs are tri-stated.
14, 15	OUT2	H-Bridge Output 2	Output 2 of H-Bridge.
17	C <sub>CP</sub>	Charge Pump Capacitor	External reservoir capacitor connection for internal charge pump capacitor.
18	D1	Disable 1	Active High input used to simultaneously tri-state disable both H-Bridge outputs. When D1 is logic High, both outputs are tri-stated.
19	IN2	Logic Input Control 2	True logic input control of OUT2 (i.e., IN2 logic High = OUT2 logic High).

## MAXIMUM RATINGS

All voltages are with respect to ground unless otherwise noted.

Rating	Symbol	Value	Unit
Supply Voltage	V+	40	V
Input Voltage (Note 1)	V <sub>IN</sub>	-0.1 to 7.0	V
$\overline{\text{FS}}$ Status Output (Note 2)	V <sub><math>\overline{\text{FS}}</math></sub>	7.0	V
Continuous Current (Note 3)	I <sub>OUT</sub>	5.0	A
ESD Voltage for DH Package Human Body Model (Note 4) Machine Model (Note 5)	V <sub>ESD1</sub> V <sub>ESD2</sub>	±2000 (Note 6) ±200	V
ESD Voltage for VW Package Human Body Model (Note 4) Machine Model (Note 5)	V <sub>ESD1</sub> V <sub>ESD2</sub>	±2000 ±200	V
Storage Temperature	T <sub>STG</sub>	-65 to 150	°C
Ambient Operating Temperature (Note 7)	T <sub>A</sub>	-40 to 125	°C
Operating Junction Temperature	T <sub>J</sub>	-40 to 150	°C
Terminal Soldering Temperature (Note 8) DH Suffix VW (Pb-Free Suffix)	T <sub>SOLDER</sub>	220 260	°C
Approximate Junction-to-Board Thermal Resistance (and Package Dissipation = 6.0 W) (Note 9)	R <sub>θJB</sub>	~5.0	°C/W

### Notes

- Exceeding the input voltage on IN1, IN2, D1, or  $\overline{\text{D2}}$  may cause a malfunction or permanent damage to the device.
- Exceeding the pull-up resistor voltage on the open drain  $\overline{\text{FS}}$  terminal may cause permanent damage to the device.
- Continuous current capability so long as junction temperature is  $\leq 150^\circ\text{C}$ .
- ESD1 testing is performed in accordance with the Human Body Model (C<sub>ZAP</sub> = 100 pF, R<sub>ZAP</sub> = 1500 Ω).
- ESD2 testing is performed in accordance with the Machine Model (C<sub>ZAP</sub> = 200 pF, R<sub>ZAP</sub> = 0 Ω).
- All terminals are capable of Human Body Model ESD voltages of ±2000 V with two exceptions pertaining only to the DH suffix package: (1)  $\overline{\text{D2}}$  to PGND is capable of ±1500 V and (2) OUT1 to AGND is capable of ±1000 V.
- The limiting factor is junction temperature, taking into account the power dissipation, thermal resistance, and heatsinking.
- Terminal soldering temperature limit is for 10 seconds maximum duration. Not designed for immersion soldering. Exceeding these limits may cause malfunction or permanent damage to the device.
- Exposed heatsink pad plus the power and ground terminals comprise the main heat conduction paths. The actual R<sub>θJB</sub> (junction-to-PC board) values will vary depending on solder thickness and composition and copper trace.

## STATIC ELECTRICAL CHARACTERISTICS

Characteristics noted under conditions  $5.0\text{ V} \leq V^+ \leq 28\text{ V}$  and  $-40^\circ\text{C} \leq T_A \leq 125^\circ\text{C}$  unless otherwise noted. Typical values noted reflect the approximate parameter mean at  $T_A = 25^\circ\text{C}$  under nominal conditions unless otherwise noted.

Characteristic	Symbol	Min	Typ	Max	Unit
----------------	--------	-----	-----	-----	------

### POWER SUPPLY

Operating Voltage Range (Note 10)	$V^+$	5.0	–	40	V
Standby Supply Current $V_{EN} = 5.0\text{ V}$ , $I_{OUT} = 0\text{ A}$	$I_{Q(\text{standby})}$	–	–	20	mA
Threshold Supply Voltage					
Switch-OFF	$V^+(\text{thres-OFF})$	4.15	4.4	4.65	V
Switch-ON	$V^+(\text{thres-ON})$	4.5	4.75	5.0	V
Hysteresis	$V^+(\text{hys})$	150	–	–	mV

### CHARGE PUMP

Charge Pump Voltage	$V_{CP-V^+}$				V
$V^+ = 5.0\text{ V}$		3.35	–	–	
$8.0\text{ V} \leq V^+ \leq 40\text{ V}$		–	–	20	

### CONTROL INPUTS

Input Voltage (IN1, IN2, D1, $\overline{D2}$ )					V
Threshold High	$V_{IH}$	3.5	–	–	
Threshold Low	$V_{IL}$	–	–	1.4	
Hysteresis	$V_{HYS}$	0.7	1.0	–	
Input Current (IN1, IN2, D1) (Note 11)	$I_{IN}$				$\mu\text{A}$
$V_{IN} = 0\text{ V}$		-200	-80	–	
$\overline{D2}$ Input Current (Note 12)	$I_{\overline{D2}}$				$\mu\text{A}$
$V_{\overline{D2}} = 5.0\text{ V}$		–	25	100	

#### Notes

10. Specifications are characterized over the range of  $5.0\text{ V} \leq V^+ \leq 28\text{ V}$ . Operation  $>28\text{ V}$  will cause some parameters to exceed listed min/max values. Refer to typical operating curves to extrapolate values for operation  $>28\text{ V}$  but  $\leq 40\text{ V}$ .
11. Inputs IN1, IN2, and D1 have independent internal pull-up current sources.
12. The  $\overline{D2}$  input incorporates an active internal pull-down current sink.

## STATIC ELECTRICAL CHARACTERISTICS (continued)

Characteristics noted under conditions  $5.0\text{ V} \leq V+ \leq 28\text{ V}$  and  $-40^\circ\text{C} \leq T_A \leq 125^\circ\text{C}$  unless otherwise noted. Typical values noted reflect the approximate parameter mean at  $T_A = 25^\circ\text{C}$  under nominal conditions unless otherwise noted.

Characteristic	Symbol	Min	Typ	Max	Unit
----------------	--------	-----	-----	-----	------

### POWER OUTPUTS (OUT1, OUT2)

Output-ON Resistance (Note 13) $5.0\text{ V} \leq V+ \leq 28\text{ V}, T_J = 25^\circ\text{C}$ $8.0\text{ V} \leq V+ \leq 28\text{ V}, T_J = 150^\circ\text{C}$ $5.0\text{ V} \leq V+ \leq 8.0\text{ V}, T_J = 150^\circ\text{C}$	$R_{DS(ON)}$	– – –	120 – –	– 225 300	m $\Omega$
Active Current Limiting Threshold (via Internal Constant OFF-Time PWM) (Note 14)	$I_{LIM}$	5.2	6.5	7.8	A
High-Side Short Circuit Detection Threshold	$I_{SCH}$	11	–	–	A
Low-Side Short Circuit Detection Threshold	$I_{SCL}$	8.0	–	–	A
Leakage Current (Note 15) $V_{OUT} = V+$ $V_{OUT} = GND$	$I_{OUT(leak)}$	– –	100 30	200 60	$\mu\text{A}$
Output FET Body Diode Forward Voltage Drop (Note 16) $I_{OUT} = 3.0\text{ A}$	$V_F$	–	–	2.0	V
Switch-OFF Thermal Shutdown Hysteresis	$T_{LIM}$ $T_{HYS}$	175 –	– 15	– –	$^\circ\text{C}$

### FAULT STATUS (Note 17)

Fault Status Leakage Current (Note 18) $V_{FS} = 5.0\text{ V}$	$I_{FS(leak)}$	–	–	10	$\mu\text{A}$
Fault Status Set Voltage (Note 19) $I_{FS} = 300\ \mu\text{A}$	$V_{FS(LOW)}$	–	–	1.0	V

#### Notes

13. Output-ON resistance as measured from output to V+ and ground.
14. Product with date codes of December 2002, week 51, will exhibit the values indicated in this table. Product with earlier date codes may exhibit a minimum of 6.0 A and a maximum of 8.5 A.
15. Outputs switched OFF with D1 or  $\overline{D2}$ .
16. Parameter is guaranteed by design but not production tested.
17. Fault Status output is an open drain output requiring a pull-up resistor to 5.0 V.
18. Fault Status Leakage Current is measured with Fault Status High and *not* set.
19. Fault Status Set Voltage is measured with Fault Status Low and set with  $I_{FS} = 300\ \mu\text{A}$ .

## DYNAMIC ELECTRICAL CHARACTERISTICS

Characteristics noted under conditions  $5.0\text{ V} \leq V+ \leq 28\text{ V}$  and  $-40^\circ\text{C} \leq T_A \leq 125^\circ\text{C}$  unless otherwise noted. Typical values noted reflect the approximate parameter mean at  $T_A = 25^\circ\text{C}$  under nominal conditions unless otherwise noted.

Characteristic	Symbol	Min	Typ	Max	Unit
<b>TIMING CHARACTERISTICS</b>					
PWM Frequency (Note 20)	$f_{\text{PWM}}$	–	–	10	kHz
Maximum Switching Frequency During Active Current Limiting (Note 21)	$f_{\text{MAX}}$	–	–	20	kHz
Output ON Delay (Note 22) $V+ = 14\text{ V}$	$t_{\text{d(ON)}}$	–	–	18	$\mu\text{s}$
Output OFF Delay (Note 22) $V+ = 14\text{ V}$	$t_{\text{d(OFF)}}$	–	–	18	$\mu\text{s}$
Output Rise and Fall Time (Note 23) $V+ = 14\text{ V}, I_{\text{OUT}} = 3.0\text{ A}$	$t_{\text{f}}, t_{\text{r}}$	2.0	5.0	8.0	$\mu\text{s}$
Output Latch-OFF Time	$t_{\text{a}}$	15	20.5	26	$\mu\text{s}$
Output Blanking Time	$t_{\text{b}}$	12	16.5	21	$\mu\text{s}$
Output FET Body Diode Reverse Recovery Time (Note 24)	$t_{\text{rr}}$	100	–	–	ns
Disable Delay Time (Note 25)	$t_{\text{d(disable)}}$	–	–	8.0	$\mu\text{s}$
Short Circuit/Overtemperature Turn-OFF Time (Note 26)	$t_{\text{FAULT}}$	–	4.0	–	$\mu\text{s}$
Power-OFF Delay Time	$t_{\text{pod}}$	–	1.0	5.0	ms

### Notes

20. The outputs can be PWM controlled from an external source. This is typically done by holding one input high while applying a PWM pulse train to the other input. The maximum PWM frequency obtainable is a compromise between switching losses and switching frequency. Refer to Typical Switching Waveforms, [Figures 11](#) through [18](#), pp. 12–13.
21. The Maximum Switching Frequency during active current limiting is internally implemented. The internal control produces a constant OFF-time PWM of the output. The output load current effects the Maximum Switching Frequency.
22. Output Delay is the time duration from the midpoint of the IN1 or IN2 input signal to the 10% or 90% point (dependent on the transition direction) of the OUT1 or OUT2 signal. If the output is transitioning High-to-Low, the delay is from the midpoint of the input signal to the 90% point of the output response signal. If the output is transitioning Low-to-High, the delay is from the midpoint of the input signal to the 10% point of the output response signal. See [Figure 2](#), page 8.
23. Rise Time is from the 10% to the 90% level and Fall Time is from the 90% to the 10% level of the output signal. See [Figure 4](#), page 8.
24. Parameter is guaranteed by design but not production tested.
25. Disable Delay Time is the time duration from the midpoint of the D (disable) input signal to 10% of the output tri-state response. See [Figure 3](#), page 8.
26. Increasing currents will become limited at  $I_{\text{LIM}}$ . Hard shorts will breach the  $I_{\text{SCH}}$  or  $I_{\text{SCL}}$  limit, forcing the output into an immediate tri-state latch-OFF. See [Figures 6](#) and [7](#), page 9. Active current limiting will cause junction temperatures to rise. A junction temperature above  $160^\circ\text{C}$  will cause the active current limiting to progressively "fold back" (or decrease) to 2.5 A typical at  $175^\circ\text{C}$  where thermal latch-OFF will occur. See [Figure 5](#), page 8.

Timing Diagrams

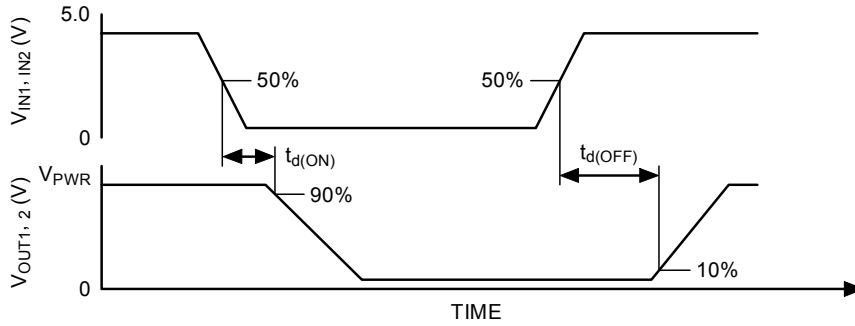

Figure 2. Output Delay Time

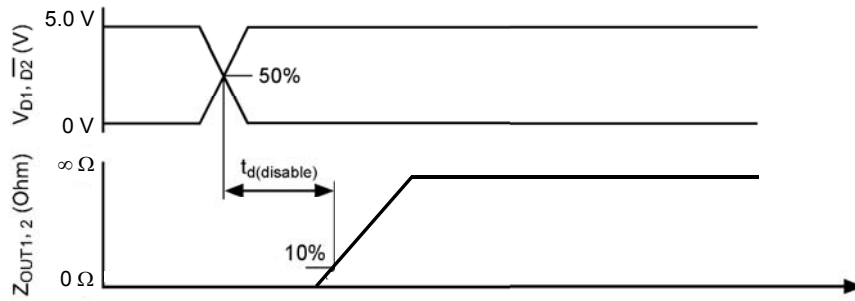

Figure 3. Disable Delay Time

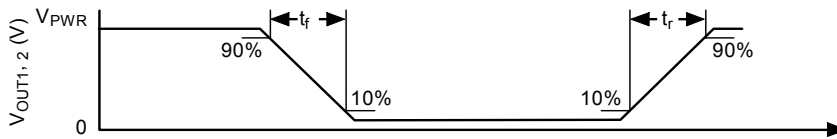

Figure 4. Output Switching Time

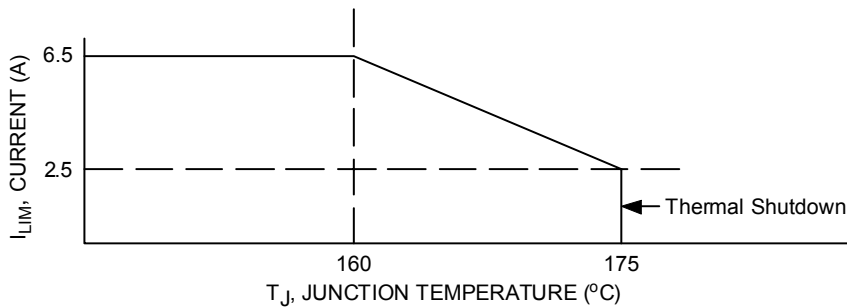

Figure 5. Active Current Limiting Versus Temperature (Typical)



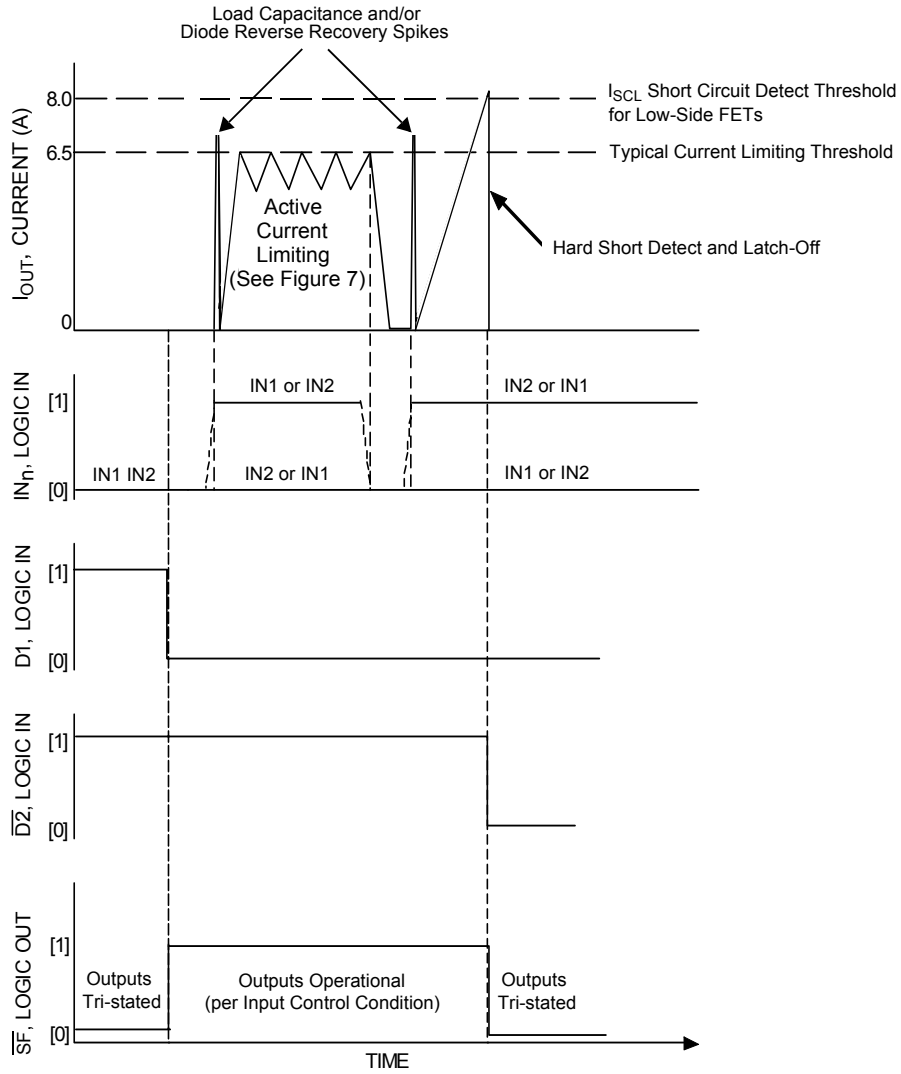

Figure 6. Active Current Limiting Versus Time

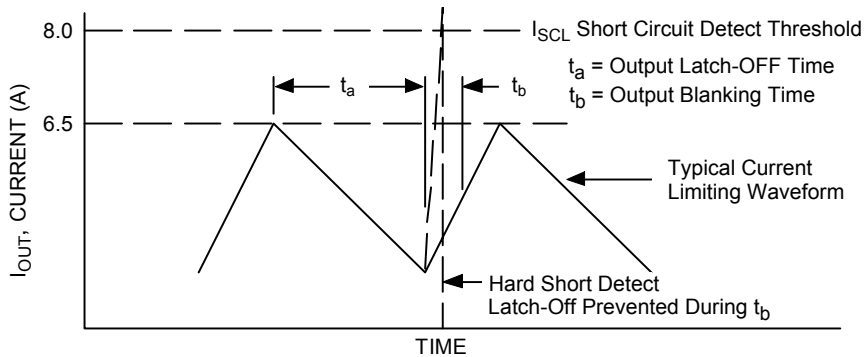

Figure 7. Active Current Limiting Detail

Electrical Performance Curves

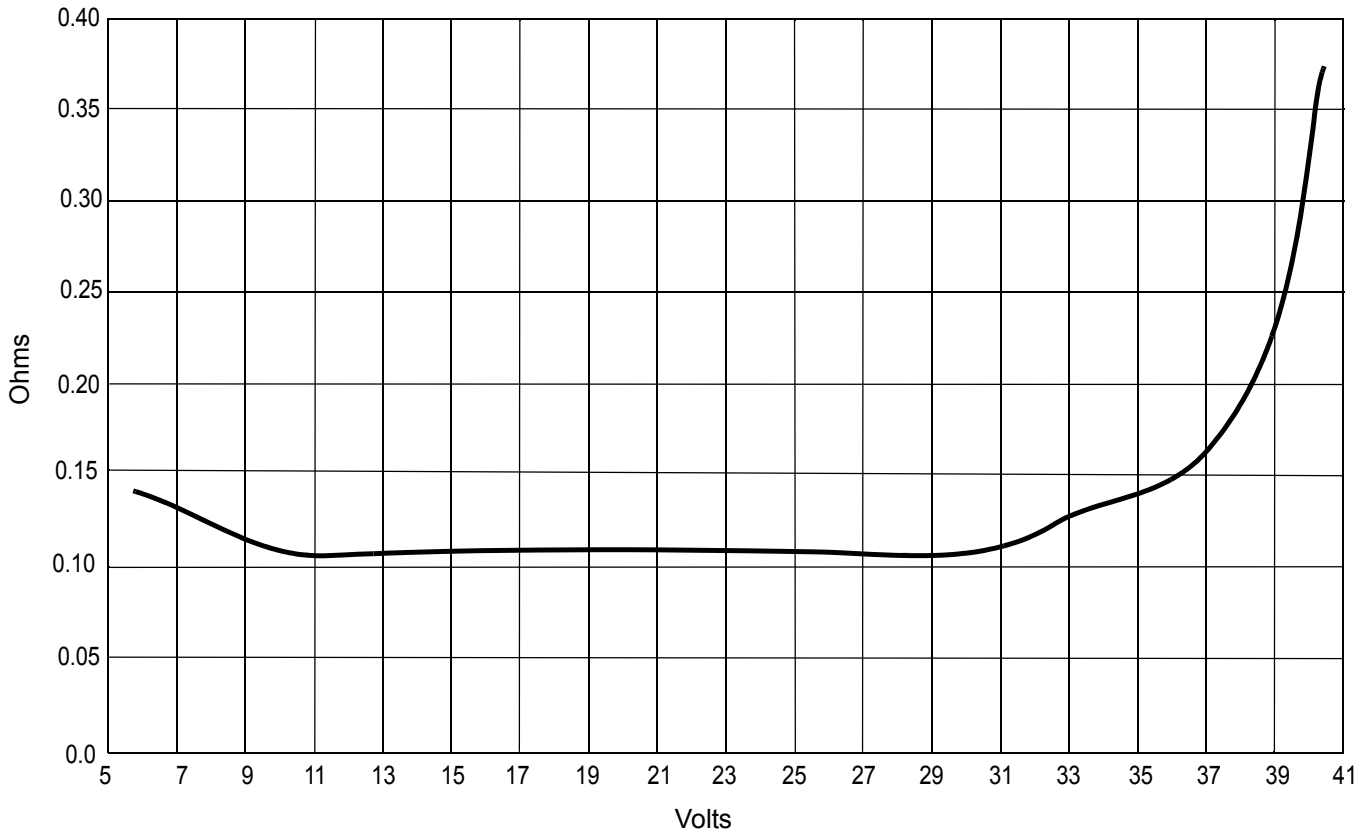

Figure 8. Typical High-Side  $R_{DS(ON)}$  Versus  $V+$

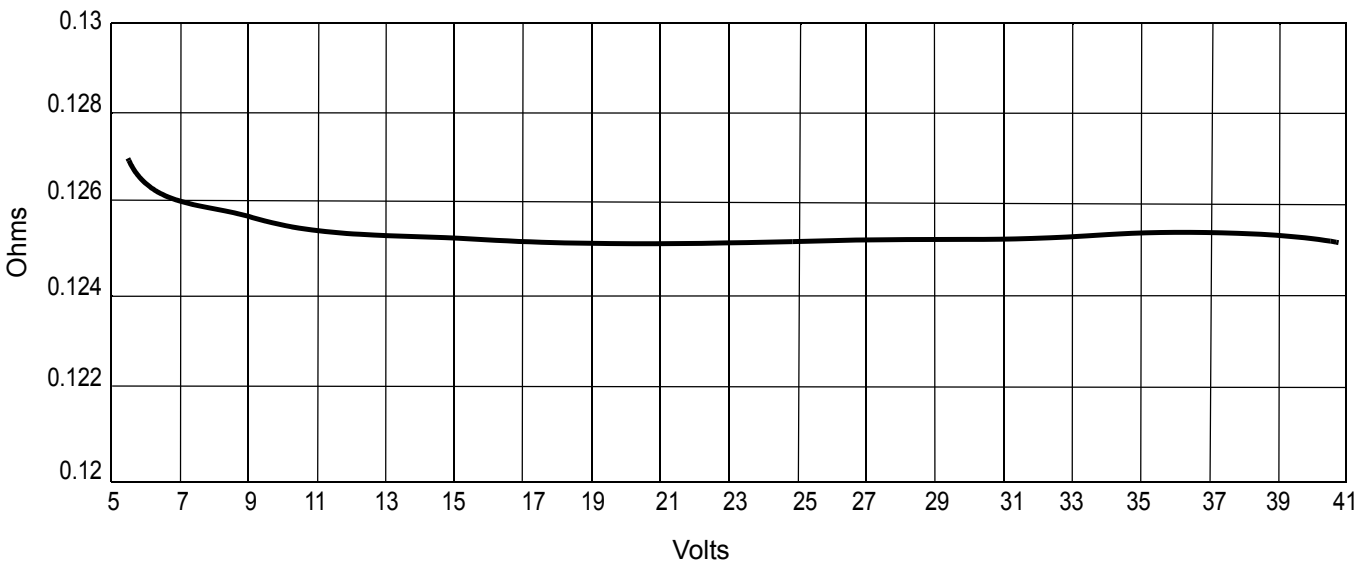

Figure 9. Typical Low-Side  $R_{DS(ON)}$  Versus  $V+$

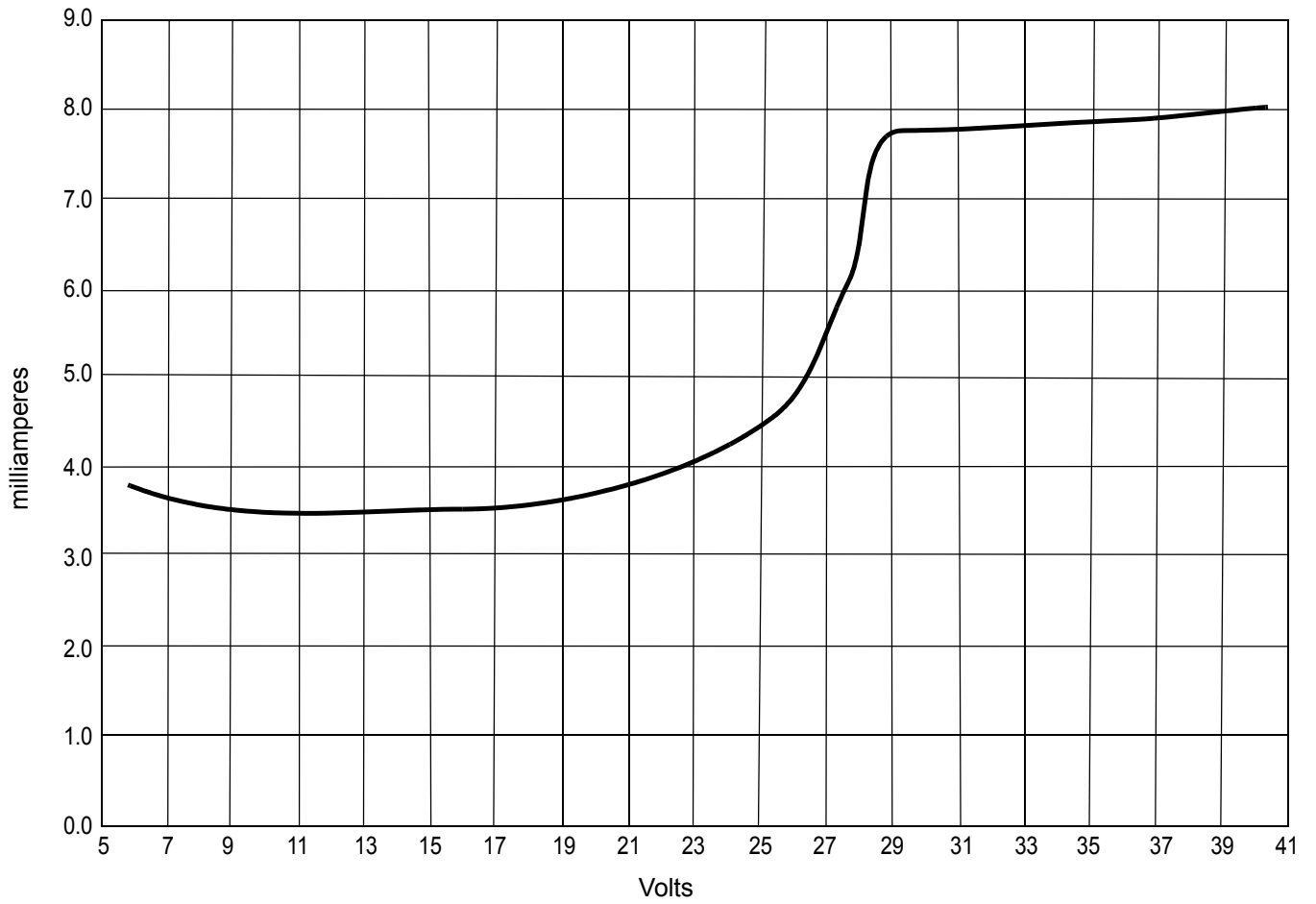

Figure 10. Typical Quiescent Supply Current Versus V+

## Typical Switching Waveforms

**Important** For all plots, the following applies:

- Ch2=2.0 A per division
- $L_{LOAD}=533 \mu\text{H}$  @ 1.0 kHz
- $L_{LOAD}=530 \mu\text{H}$  @ 10.0 kHz
- $R_{LOAD}=4.0 \Omega$

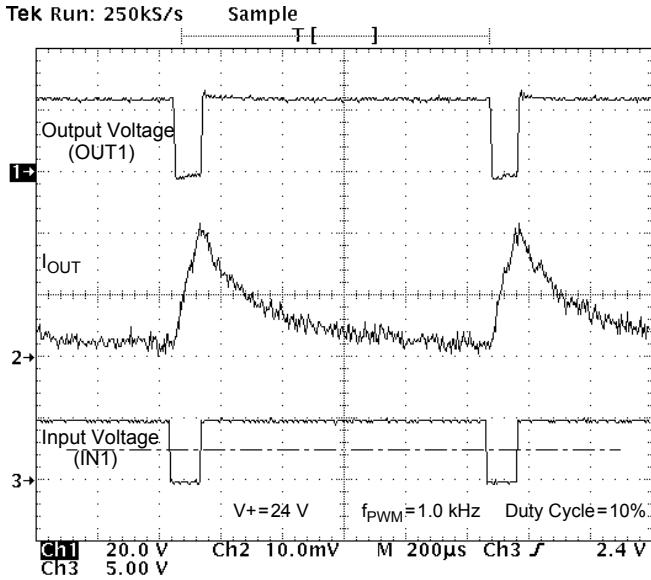

Figure 11. Output Voltage and Current vs. Input Voltage at  $V^+ = 24 \text{ V}$ , PMW Frequency of 1.0 kHz, and Duty Cycle of 10%

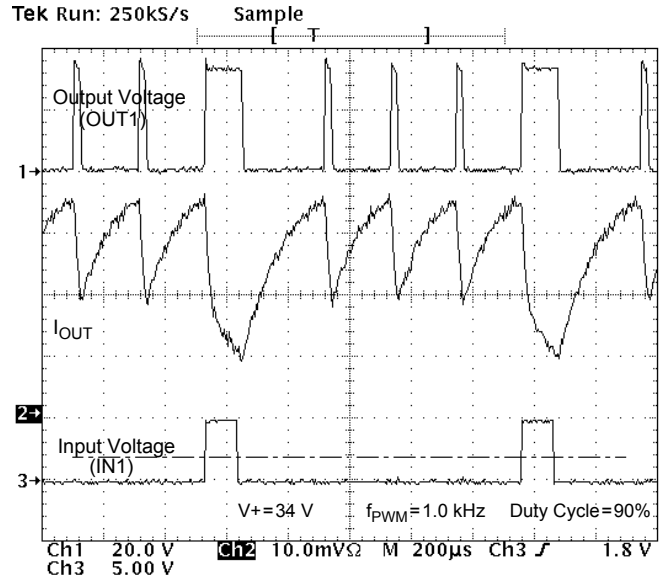

Figure 13. Output Voltage and Current vs. Input Voltage at  $V^+ = 34 \text{ V}$ , PMW Frequency of 1.0 kHz, and Duty Cycle of 90%, Showing Device in Current Limiting Mode

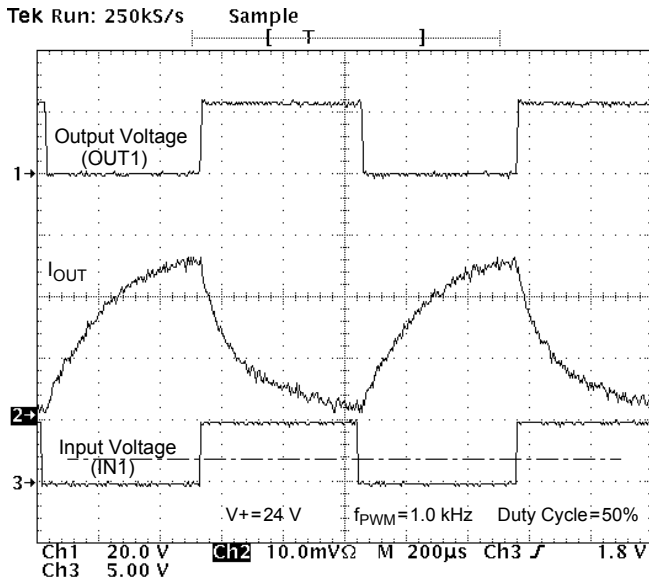

Figure 12. Output Voltage and Current vs. Input Voltage at  $V^+ = 24 \text{ V}$ , PMW Frequency of 1.0 kHz, and Duty Cycle of 50%

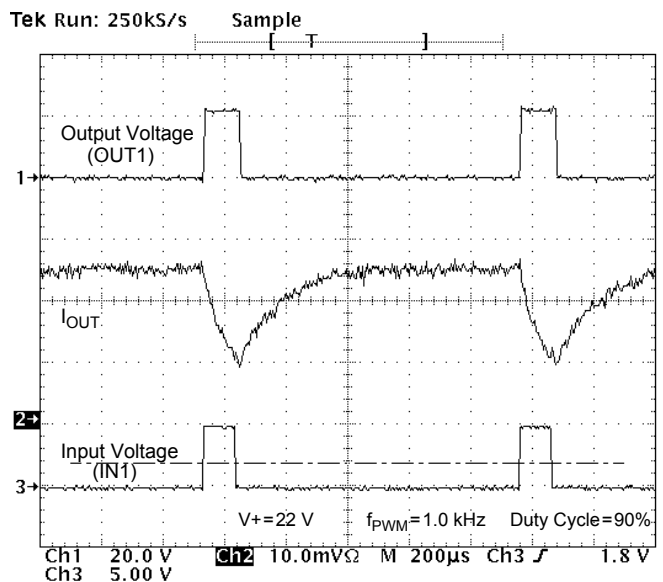

Figure 14. Output Voltage and Current vs. Input Voltage at  $V^+ = 22 \text{ V}$ , PMW Frequency of 1.0 kHz, and Duty Cycle of 90%

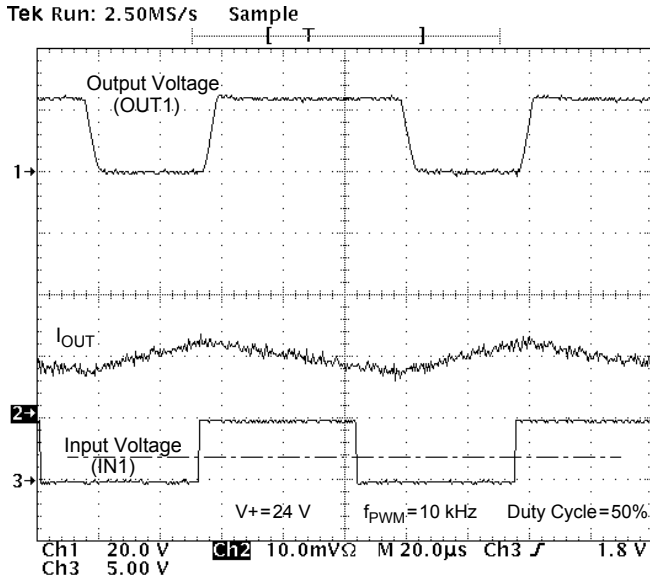

Figure 15. Output Voltage and Current vs. Input Voltage at V+ = 24 V, PMW Frequency of 10 kHz, and Duty Cycle of 50%

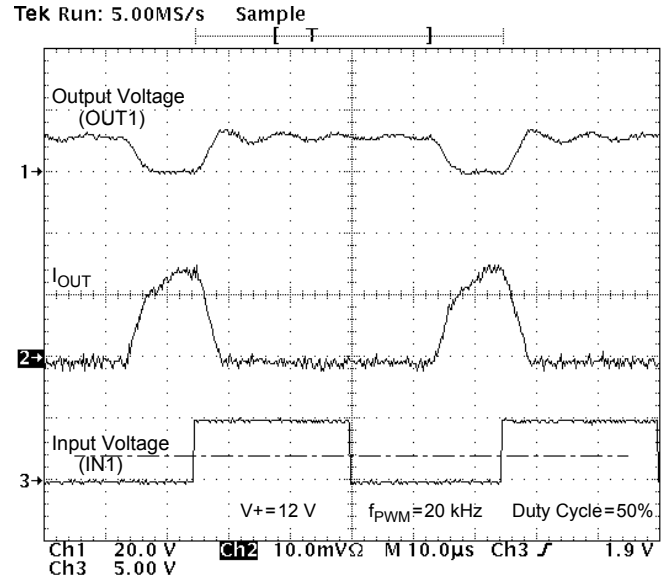

Figure 17. Output Voltage and Current vs. Input Voltage at V+ = 12 V, PMW Frequency of 20 kHz, and Duty Cycle of 50% for a Purely Resistive Load

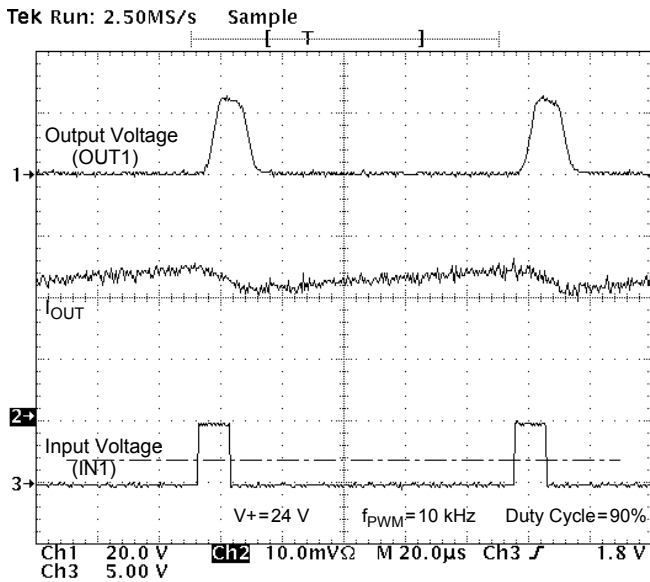

Figure 16. Output Voltage and Current vs. Input Voltage at V+ = 24 V, PMW Frequency of 10 kHz, and Duty Cycle of 90%

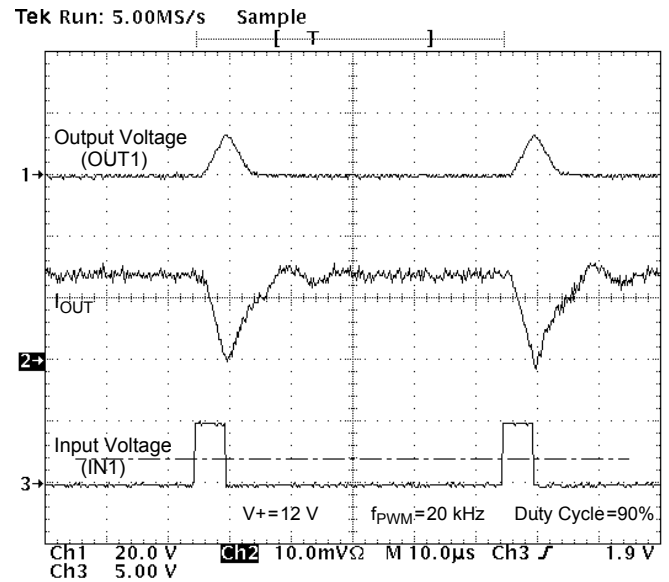

Figure 18. Output Voltage and Current vs. Input Voltage at V+ = 12 V, PMW Frequency of 20 kHz, and Duty Cycle of 90% for a Purely Resistive Load

**Table 1. Truth Table**

The tri-state conditions and the fault status are reset using D1 or  $\overline{D2}$ . The truth table uses the following notations: L = Low, H = High, X = High or Low, and Z = High impedance (all output power transistors are switched off).

Device State	Input Conditions				Fault Status Flag	Output States	
	D1	$\overline{D2}$	IN1	IN2	$\overline{FS}$	OUT1	OUT2
Forward	L	H	H	L	H	H	L
Reverse	L	H	L	H	H	L	H
Freewheeling Low	L	H	L	L	H	L	L
Freewheeling High	L	H	H	H	H	H	H
Disable 1 (D1)	H	X	X	X	L	Z	Z
Disable 2 ( $\overline{D2}$ )	X	L	X	X	L	Z	Z
IN1 Disconnected	L	H	Z	X	H	H	X
IN2 Disconnected	L	H	X	Z	H	X	H
D1 Disconnected	Z	X	X	X	L	Z	Z
$\overline{D2}$ Disconnected	X	Z	X	X	L	Z	Z
Undervoltage (Note 27)	X	X	X	X	L	Z	Z
Overtemperature (Note 28)	X	X	X	X	L	Z	Z
Short Circuit (Note 28)	X	X	X	X	L	Z	Z

**Notes**

27. In the case of an undervoltage condition, the outputs tri-state and the fault status is set logic Low. Upon undervoltage recovery, fault status is reset automatically or automatically cleared and the outputs are restored to their original operating condition.
28. When a short circuit or overtemperature condition is detected, the power outputs are tri-state latched-OFF independent of the input signals and the fault status flag is set logic Low.

## SYSTEM/APPLICATION INFORMATION

### INTRODUCTION

Numerous protection and operational features (speed, torque, direction, dynamic braking, and PWM control), in addition to the 5.0 A current capability, make the 33886 a very attractive, cost-effective solution for controlling a broad range of fractional horsepower DC motors. A pair of 33886 devices can be used to control bipolar stepper motors in both directions. In addition, the 33886 can be used to control permanent magnet solenoids in a push-pull variable force fashion using PWM control. The 33886 can also be used to excite transformer primary windings with a switched square wave to produce secondary winding AC currents.

As shown in [Figure 1](#), Simplified Internal Block Diagram, page 2, the 33886 is a fully protected monolithic H-Bridge with Fault Status reporting. For a DC motor to run the input conditions need be as follows: D1 input logic Low, D2 input logic High,  $\overline{FS}$  flag cleared (logic High), with one IN logic Low and the other IN logic High to define output polarity. The 33886 can execute dynamic braking by simultaneously turning on either both high-side MOSFETs or both low-side MOSFETs in the output H-Bridge; e.g., IN1 and IN2 logic High or IN1 and IN2 logic Low.

The 33886 outputs are capable of providing a continuous DC load current of 5.0 A from a 40 V V+ source. An internal charge pump supports PWM frequencies up to 10 kHz. An external pull-up resistor is required for the open drain FS terminal for fault status reporting.

Two independent inputs (IN1 and IN2) provide control of the two totem-pole half-bridge outputs. Two disable inputs (D1 and D2) are for forcing the H-Bridge outputs to a high impedance state (all H-Bridge switches OFF).

The 33886 has undervoltage shutdown with automatic recovery, active current limiting, output short-circuit latch-OFF, and overtemperature latch-OFF. An undervoltage shutdown, output short circuit latch-OFF, or overtemperature latch-OFF fault condition will cause the outputs to turn OFF (i.e., become high impedance or tri-stated) and the fault output flag to be set Low. Either of the Disable inputs or V+ must be “toggled” to clear the fault flag.

The short circuit/overtemperature shutdown scheme is unique and best described as using a junction temperature-dependent active current “fold back” protection scheme. When a short circuit condition is experienced, the current limited output is “ramped down” as the junction temperature increases above 160°C, until at 175°C the current has decreased to about 2.5 A. Above 175°C, overtemperature shutdown (latch-OFF) occurs. This feature allows the device to remain in operation for a longer time with unexpected loads, while still retaining adequate protection for both the device and the load.

### FUNCTIONAL TERMINAL DESCRIPTION

#### PGND and AGND

Power and analog ground terminals. The power and analog ground terminals should be connected together with a very low impedance connection.

#### V+

V+ terminals are the power supply inputs to the device. All V+ terminals must be connected together on the printed circuit board with as short as possible traces offering as low impedance as possible between terminals.

V+ terminals have an undervoltage threshold. If the supply voltage drops below a V+ undervoltage threshold, the output power stage switches to a tri-state condition and the fault status flag is set and the Fault Status terminal voltage switched to a logic Low. When the supply voltage returns to a level that is above the threshold, the power stage automatically resumes normal operation according to the established condition of the input terminals and the fault status flag is automatically reset logic High.

#### Fault Status ( $\overline{FS}$ )

This terminal is the device fault status output. This output is an active Low open drain structure requiring a pull-up resistor to 5.0 V. Refer to [Table 1, Truth Table](#), page 14.

#### IN1, IN2, D1, and $\overline{D2}$

These terminals are input control terminals used to control the outputs. These terminals are 5.0 V CMOS-compatible inputs with hysteresis. The IN1 and IN2 independently control OUT1 and OUT2, respectively. D1 and  $\overline{D2}$  are complimentary inputs used to tri-state disable the H-Bridge outputs.

When either D1 or  $\overline{D2}$  is set (D1 = logic High or  $\overline{D2}$  = logic Low) in the disable state, outputs OUT1 and OUT2 are both tri-state disabled; however, the rest of the device circuitry is fully operational and the supply  $I_{Q(standby)}$  current is reduced to a few milliamperes. Refer to [Table 1, Truth Table](#), and [STATIC ELECTRICAL CHARACTERISTICS](#) table, page 5.

## OUT1 and OUT2

These terminals are the outputs of the H-Bridge with integrated output FET body diodes. The bridge output is controlled using the IN1, IN2, D1, and  $\overline{D2}$  inputs. The outputs have active current limiting above 6.5 A. The outputs also have thermal shutdown (tri-state latch-OFF) with hysteresis as well as short circuit latch-OFF protection.

A disable timer (time  $t_b$ ) incorporated to detect currents that are higher than active current limit is activated at each output activation to facilitate detecting hard output short conditions (see [Figure 7](#), page 9).

## C<sub>CP</sub>

Charge pump output terminal. A filter capacitor (up to 33 nF) can be connected from the C<sub>CP</sub> terminal and PGND. The device can operate without the external capacitor, although the C<sub>CP</sub> capacitor helps to reduce noise and allows the device to perform at maximum speed, timing, and PWM frequency.

## PERFORMANCE FEATURES

### Short Circuit Protection

If an output short circuit condition is detected, the power outputs tri-state (latch-OFF) independent of the input (IN1 and IN2) states, and the fault status output flag is set logic Low. If the D1 input changes from logic High to logic Low, or if the  $\overline{D2}$  input changes from logic Low to logic High, the output bridge will become operational again and the fault status flag will be reset (cleared) to a logic High state.

The output stage will always switch into the mode defined by the input terminals (IN1, IN2, D1, and  $\overline{D2}$ ), provided the device junction temperature is within the specified operating temperature.

### Active Current Limiting

The maximum current flow under normal operating conditions is internally limited to  $I_{LIM}$  (5.2 A to 7.8 A). When the maximum current value is reached, the output stages are tri-stated for a fixed time ( $t_a$ ) of 20  $\mu$ s typical. Depending on the time constant associated with the load characteristics, the current decreases during the tri-state duration until the next output ON cycle occurs (see [Figures 7](#) and [13](#), page 9 and page 12, respectively).

The current limiting threshold value is dependent upon the device junction temperature. When  $-40^\circ\text{C} < T_J < 160^\circ\text{C}$ ,  $I_{LIM}$  is between 5.2 A and 7.8 A. When  $T_J$  exceeds  $160^\circ\text{C}$ , the  $I_{LIM}$  current decreases linearly down to 2.5 A typical at  $175^\circ\text{C}$ . Above  $175^\circ\text{C}$  the device overtemperature circuit detects  $T_{LIM}$  and overtemperature shutdown occurs (see [Figure 5](#), page 8). This feature allows the device to remain operational for a longer time but at a regressing output performance level at junction temperatures above  $160^\circ\text{C}$ .

### Overtemperature Shutdown and Hysteresis

If an overtemperature condition occurs, the power outputs are tri-state (latched-OFF) independent of the input signals and the fault status flag is set logic Low.

To reset from this condition, D1 must change from logic High to logic Low, or  $\overline{D2}$  must change from logic Low to logic High. When reset, the output stage switches ON again, provided that the junction temperature is now below the overtemperature threshold limit minus the hysteresis.

**Note** Resetting from the fault condition will clear the fault status flag.

### Main Differences Compared to MC33186DH1

- COD terminal has been removed. Terminal 8 is now a Do Not Connect (DNC) terminal.
- Terminal 20 is no longer connected in the 20 HSOP package. It is now a DNC terminal.
- $R_{DS(ON)}$  max at  $T_J = 150^\circ\text{C}$  is now 225 m $\Omega$  per each output transistor.
- Maximum temperature operation is now  $160^\circ\text{C}$ , as minimum thermal shutdown temperature has increased.
- Current regulation limiting foldback is implemented above  $160^\circ\text{C}$   $T_J$ .
- Thermal resistance junction to case has been increased from  $\sim 2.0^\circ\text{C/W}$  to  $\sim 5.0^\circ\text{C/W}$ .



## PACKAGE INFORMATION

The 33886 is designed for enhanced thermal performance. The significant feature of this device is the exposed copper pad on which the power die is soldered. This pad is soldered on a PCB to provide heat flow to ambient and also to provide thermal capacitance. The more copper area on the PCB, the better the power dissipation and transient behavior will be.

**Example** Characterization on a double-sided PCB: bottom side area of copper is 7.8 cm<sup>2</sup>; top surface is 2.7 cm<sup>2</sup> (see [Figure 19](#)); grid array of 24 vias 0.3 mm in diameter.

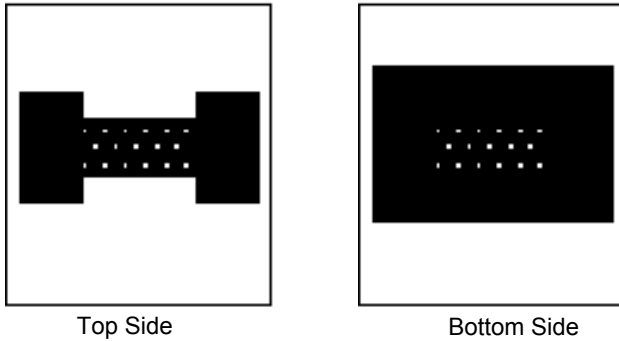

Figure 19. PCB Test Layout

[Figure 20](#) shows the thermal response with the device soldered on to the test PCB described in [Figure 19](#).

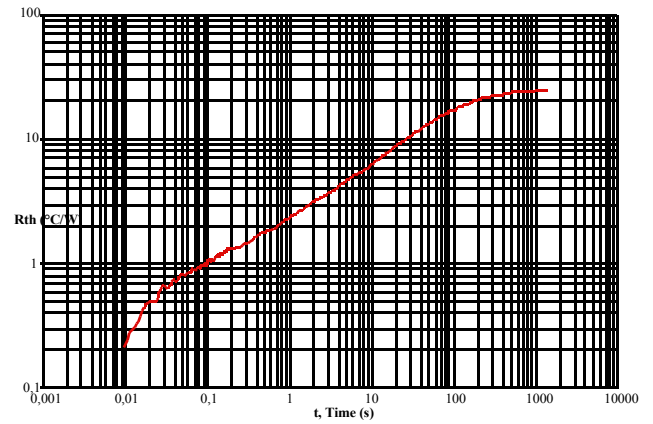

Figure 20. 33886 Thermal Response

## APPLICATIONS

A typical application schematic is shown in [Figure 21](#). For precision high-current applications in harsh, noisy

environments, the V+ by-pass capacitor may need to be substantially larger.

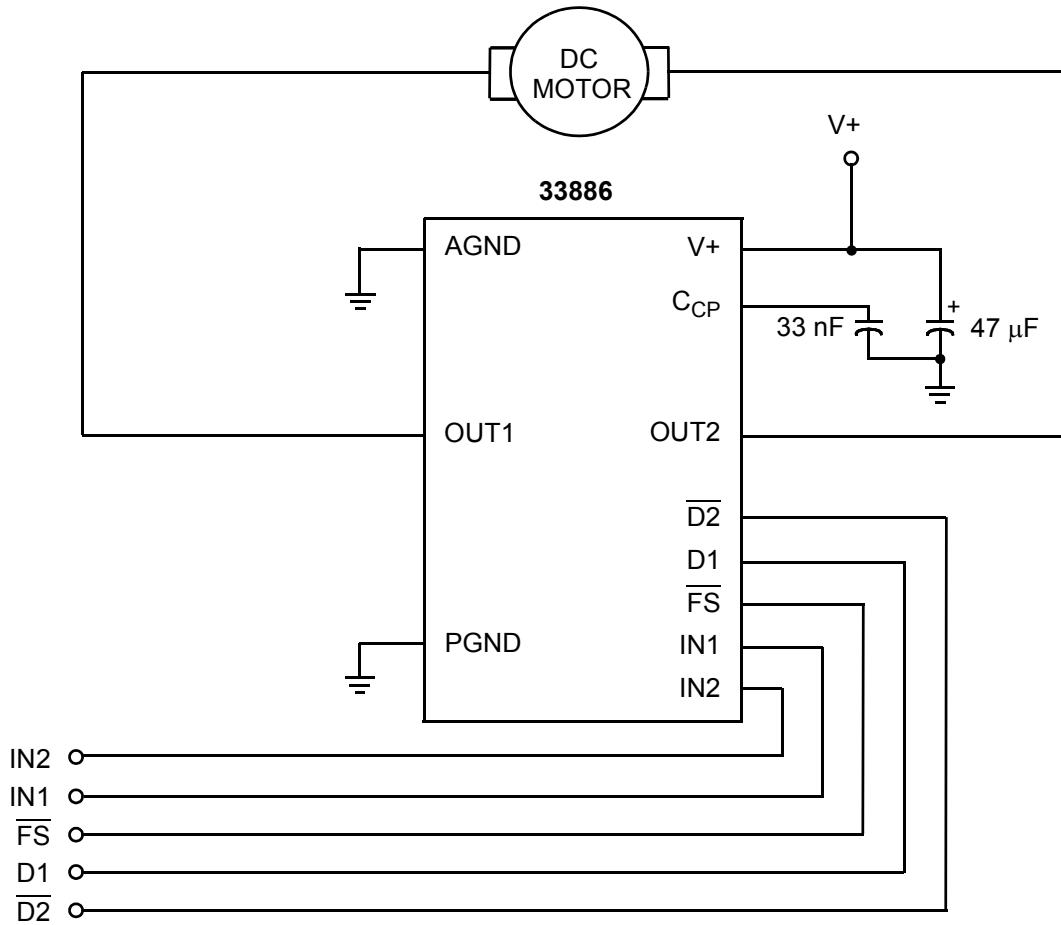
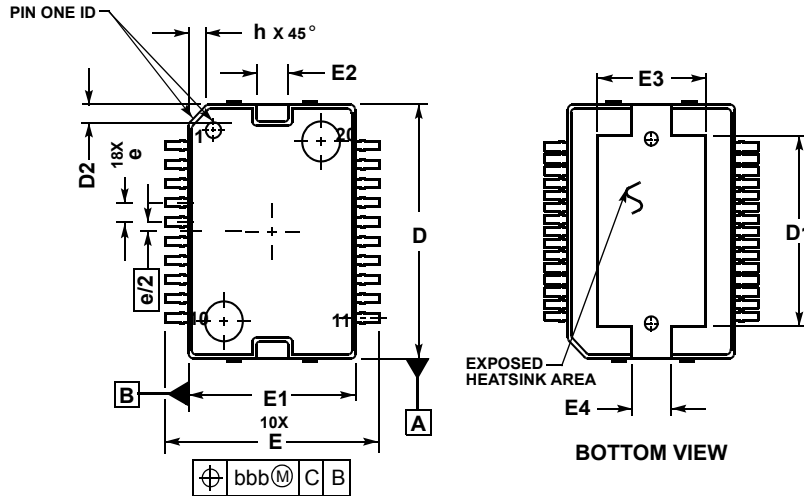

Figure 21. 33886 Typical Application Schematic

## PACKAGE DIMENSIONS

DH SUFFIX  
 VW (Pb-FREE) SUFFIX  
 20-TERMINAL HSOP  
 PLASTIC PACKAGE  
 CASE 979C-02  
 ISSUE A



NOTES:

1. CONTROLLING DIMENSION: MILLIMETER.
2. DIMENSIONS AND TOLERANCES PER ASME Y14.5M, 1994.
3. DATUM PLANE -H- IS LOCATED AT BOTTOM OF LEAD AND IS COINCIDENT WITH THE LEAD WHERE THE LEAD EXITS THE PLASTIC BODY AT THE BOTTOM OF THE PARTING LINE.
4. DIMENSIONS D AND E1 DO NOT INCLUDE MOLD PROTRUSION. ALLOWABLE PROTRUSION IS 0.150 PER SIDE. DIMENSIONS D AND E1 DO INCLUDE MOLD MISMATCH AND ARE DETERMINED AT DATUM PLANE -H-.
5. DIMENSION b DOES NOT INCLUDE DAMBAR PROTRUSION. ALLOWABLE DAMBAR PROTRUSION SHALL BE 0.127 TOTAL IN EXCESS OF THE b DIMENSION AT MAXIMUM MATERIAL CONDITION.
6. DATUMS -A- AND -B- TO BE DETERMINED AT DATUM PLANE -H-.
7. DIMENSION D DOES NOT INCLUDE TIEBAR PROTRUSIONS. ALLOWABLE TIEBAR PROTRUSIONS ARE 0.150 PER SIDE.

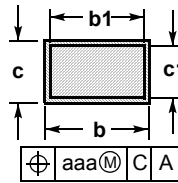
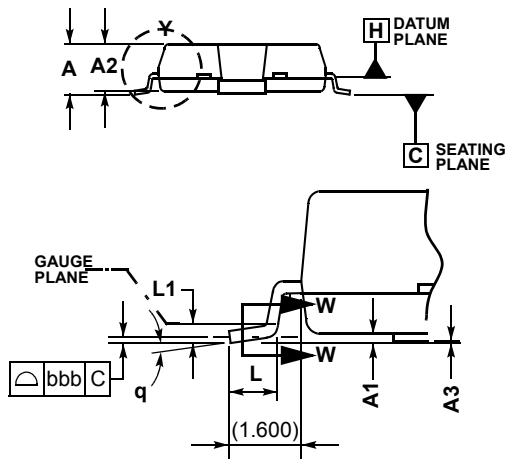

SECTION W-W

MILLIMETERS		
DIM	MIN	MAX
A	3.000	3.400
A1	0.100	0.300
A2	2.900	3.100
A3	0.00	0.100
D	15.800	16.000
D1	11.700	12.600
D2	0.900	1.100
E	13.950	14.450
E1	10.900	11.100
E2	2.500	2.700
E3	6.400	7.200
E4	2.700	2.900
L	0.840	1.100
L1	0.350	BSC
b	0.400	0.520
b1	0.400	0.482
c	0.230	0.320
c1	0.230	0.280
e	1.270	BSC
h	--	1.100
q	0 °	8 °
aaa	0.200	
bbb	0.100	

DETAIL Y

Freescale Semiconductor, Inc.

Information in this document is provided solely to enable system and software implementers to use Motorola products. There are no express or implied copyright licenses granted hereunder to design or fabricate any integrated circuits or integrated circuits based on the information in this document.

Motorola reserves the right to make changes without further notice to any products herein. Motorola makes no warranty, representation or guarantee regarding the suitability of its products for any particular purpose, nor does Motorola assume any liability arising out of the application or use of any product or circuit, and specifically disclaims any and all liability, including without limitation consequential or incidental damages. "Typical" parameters which may be provided in Motorola data sheets and/or specifications can and do vary in different applications and actual performance may vary over time. All operating parameters, including "Typicals" must be validated for each customer application by customer's technical experts. Motorola does not convey any license under its patent rights nor the rights of others. Motorola products are not designed, intended, or authorized for use as components in systems intended for surgical implant into the body, or other applications intended to support or sustain life, or for any other application in which the failure of the Motorola product could create a situation where personal injury or death may occur. Should Buyer purchase or use Motorola products for any such unintended or unauthorized application, Buyer shall indemnify and hold Motorola and its officers, employees, subsidiaries, affiliates, and distributors harmless against all claims, costs, damages, and expenses, and reasonable attorney fees arising out of, directly or indirectly, any claim of personal injury or death associated with such unintended or unauthorized use, even if such claim alleges that Motorola was negligent regarding the design or manufacture of the part.

MOTOROLA and the Stylized M Logo are registered in the US Patent and Trademark Office. All other product or service names are the property of their respective owners.

© Motorola, Inc. 2004

#### HOW TO REACH US:

#### USA/EUROPE/LOCATIONS NOT LISTED:

Motorola Literature Distribution  
P.O. Box 5405, Denver, Colorado 80217  
1-800-521-6274 or 480-768-2130

**JAPAN:** Motorola Japan Ltd.; SPS, Technical Information Center  
3-20-1 Minami-Azabu, Minato-ku, Tokyo 106-8573, Japan  
81-3-3440-3569

**ASIA/PACIFIC:** Motorola Semiconductors H.K. Ltd.; Silicon Harbour Centre  
2 Dai King Street, Tai Po Industrial Estate, Tai Po, N.T., Hong Kong  
852-26668334

**HOME PAGE:** <http://motorola.com/semiconductors>



**MOTOROLA**

**For More Information On This Product,  
Go to: [www.freescale.com](http://www.freescale.com)**

MC33886/D