



MICROWAVE CORPORATION v02.0605



HMC372LP3 / 372LP3E

GaAs PHEMT MMIC LOW NOISE AMPLIFIER, 700 - 1000 MHz

Typical Applications

The HMC372LP3 / HMC372LP3E is ideal for basestation receivers:

- GSM, GPRS & EDGE
- CDMA & W-CDMA
- Private Land Mobile Radio

Features

- Noise Figure: <1.0 dB
- +34 dBm Output IP3
- Gain: 15 dB
- Very Stable Gain vs. Supply & Temperature
- Single Supply: +5.0 V @ 100 mA
- 50 Ohm Matched Output

Functional Diagram

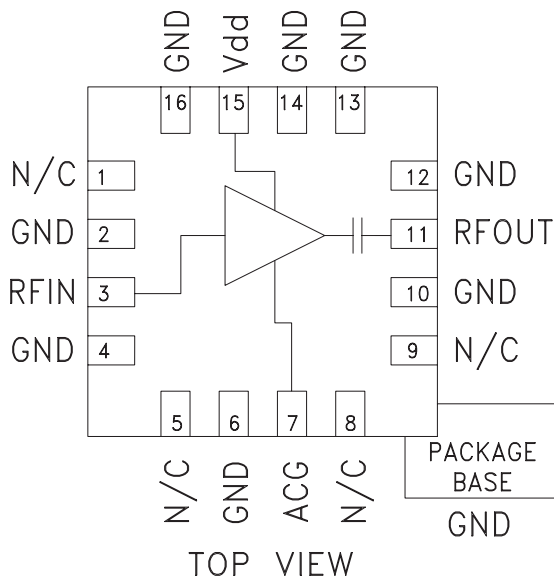

General Description

The HMC372LP3 & HMC372LP3E are GaAs PHEMT MMIC Low Noise Amplifiers that are ideal for GSM & CDMA cellular basestation front-end receivers operating between 700 and 1000 MHz. The amplifier has been optimized to provide 1.0 dB noise figure, 15 dB gain and +34 dBm output IP3 from a single supply of +5.0V @ 100 mA. Input and output return losses are 25 and 14 dB respectively with the LNA requiring only four external components to optimize the RF Input match, RF ground and DC bias. The HMC372LP3 & HMC372LP3E share the same package and pinout with the HMC356LP3 high IP3 LNA. A low cost, leadless 3x3 mm (LP3) SMT QFN package houses the low noise amplifier.

Electrical Specifications, $T_A = +25^\circ C$, $V_s = +5V$

Parameter	Min.	Typ.	Max.	Min.	Typ.	Max.	Units
Frequency Range	810 - 960			700 - 1000			MHz
Gain	12.5	14.5		11.5	14.5		dB
Gain Variation Over Temperature		0.008	0.015		0.008	0.015	dB / °C
Noise Figure		1.0	1.3		1.0	1.3	dB
Input Return Loss		25			25		dB
Output Return Loss		14			12		dB
Reverse Isolation		20			22		dB
Output Power for 1dB Compression (P1dB)	18	21		17	20		dBm
Saturated Output Power (Psat)		23.5			22.5		dBm
Output Third Order Intercept (IP3) (-20 dBm Input Power per tone, 1 MHz tone spacing)		34		30	33		dBm
Supply Current (Idd)		100			100		mA

For price, delivery, and to place orders, please contact Hittite Microwave Corporation:
 20 Alpha Road, Chelmsford, MA 01824 Phone: 978-250-3343 Fax: 978-250-3373
 Order On-line at www.hittite.com



v02.0605



HMC372LP3 / 372LP3E

GaAs PHEMT MMIC LOW NOISE AMPLIFIER, 700 - 1000 MHz

Broadband Gain & Return Loss

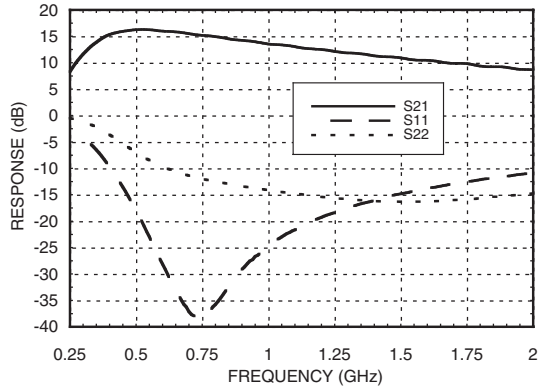

Gain, Noise Figure & Power vs. Supply Voltage @ 850MHz

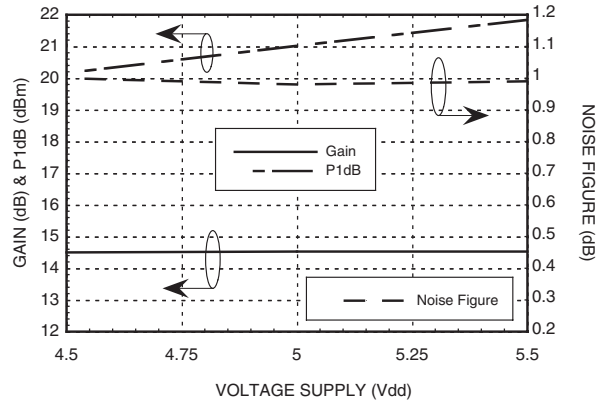

Gain vs. Temperature

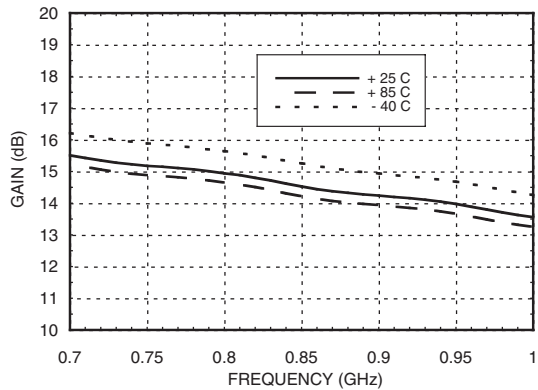

Noise Figure vs. Temperature

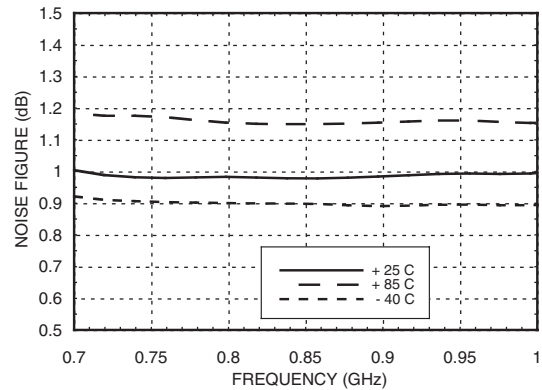

Gain vs. Vdd

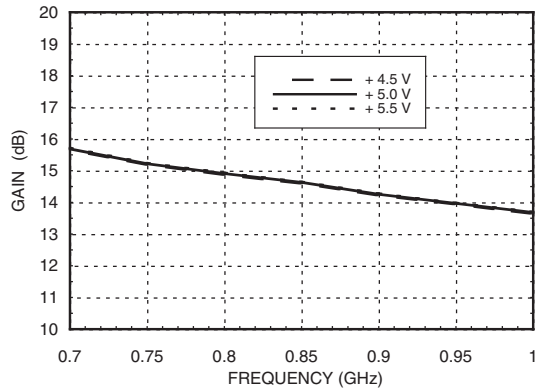

Noise Figure vs. Vdd

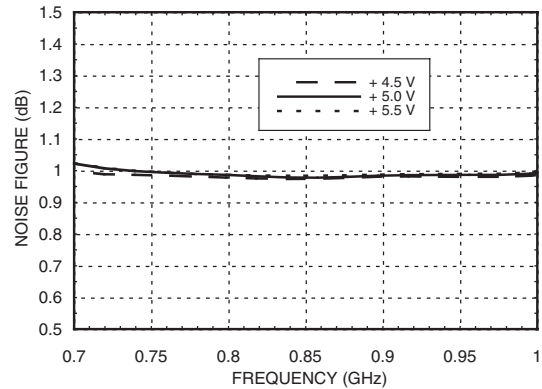

For price, delivery, and to place orders, please contact Hittite Microwave Corporation:
 20 Alpha Road, Chelmsford, MA 01824 Phone: 978-250-3343 Fax: 978-250-3373
 Order On-line at www.hittite.com



v02.0605



HMC372LP3 / 372LP3E

GaAs PHEMT MMIC LOW NOISE AMPLIFIER, 700 - 1000 MHz

AMPLIFIERS - SMT 5

Input Return Loss vs. Temperature

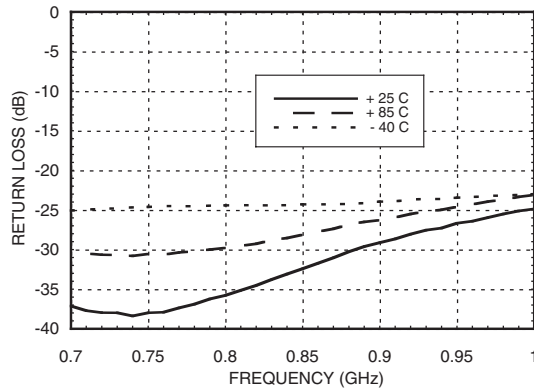

Output Return Loss vs. Temperature

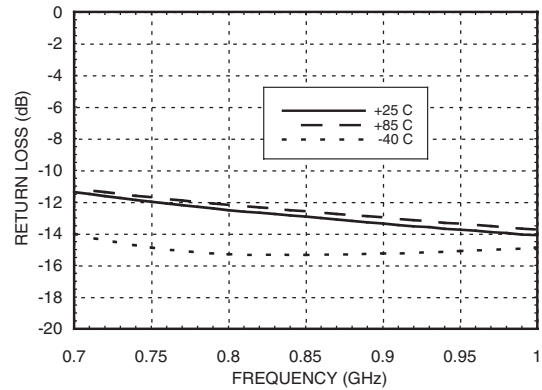

Output IP3 vs. Temperature

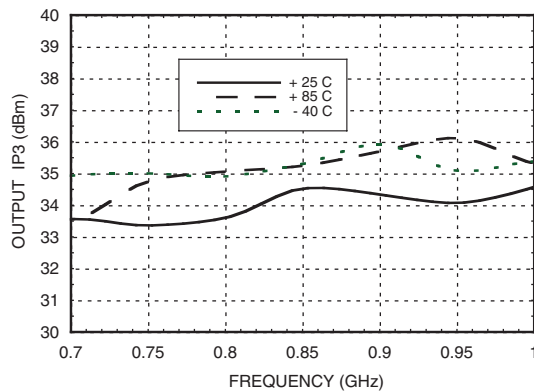

P1dB & Psat vs. Temperature

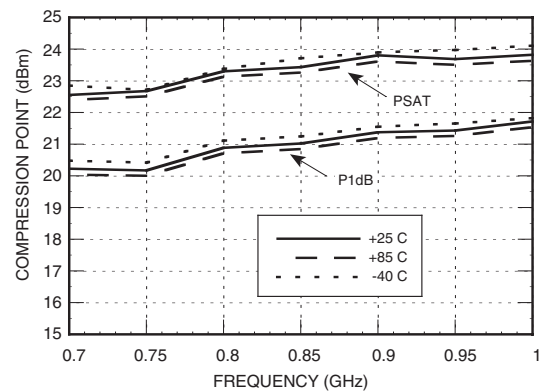

Output IP3 vs. Vdd

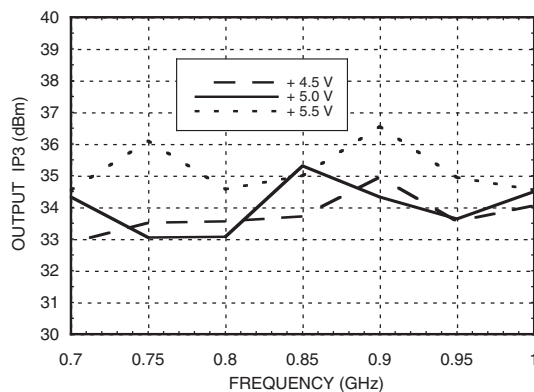

P1dB vs. Vdd

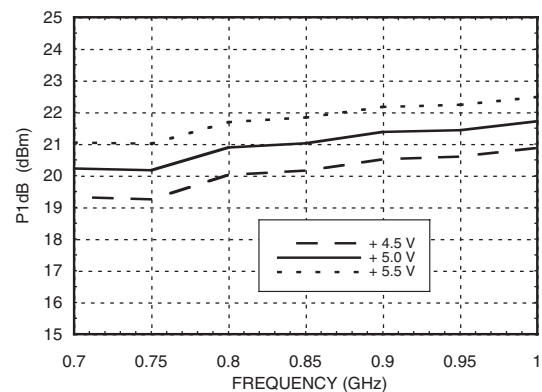



MICROWAVE CORPORATION v02.0605



HMC372LP3 / 372LP3E

**GaAs PHEMT MMIC LOW NOISE
AMPLIFIER, 700 - 1000 MHz**

Output IP3 vs. Input Power @ 950 MHz

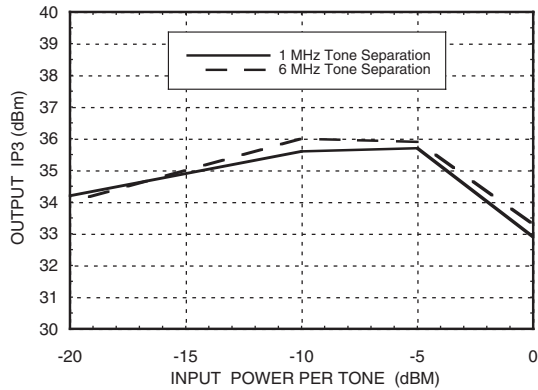

Reverse Isolation vs. Temperature

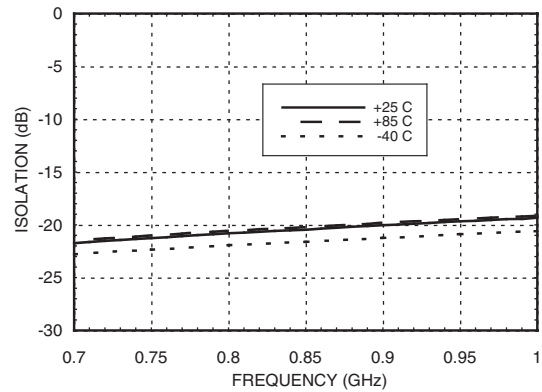



MICROWAVE CORPORATION v02.0605



HMC372LP3 / 372LP3E

GaAs PHEMT MMIC LOW NOISE AMPLIFIER, 700 - 1000 MHz

5 AMPLIFIERS - SMT

Absolute Maximum Ratings

Drain Bias Voltage (Vdd)	+8.0 Vdc
RF Input Power (RFIn)(Vs = +5.0 Vdc)	+15 dBm
Channel Temperature	150 °C
Continuous Pdiss (T = 85 °C) (derate 15.6 mW/°C above 85 °C)	1.015 W
Thermal Resistance (channel to ground paddle)	64.1 °C/W
Storage Temperature	-65 to +150 °C
Operating Temperature	-40 to +85 °C

Typical Supply Current vs. Vdd

Vdd (Vdc)	Idd (mA)
+4.5	98
+5.0	100
+5.5	102



ELECTROSTATIC SENSITIVE DEVICE
OBSERVE HANDLING PRECAUTIONS

Outline Drawing

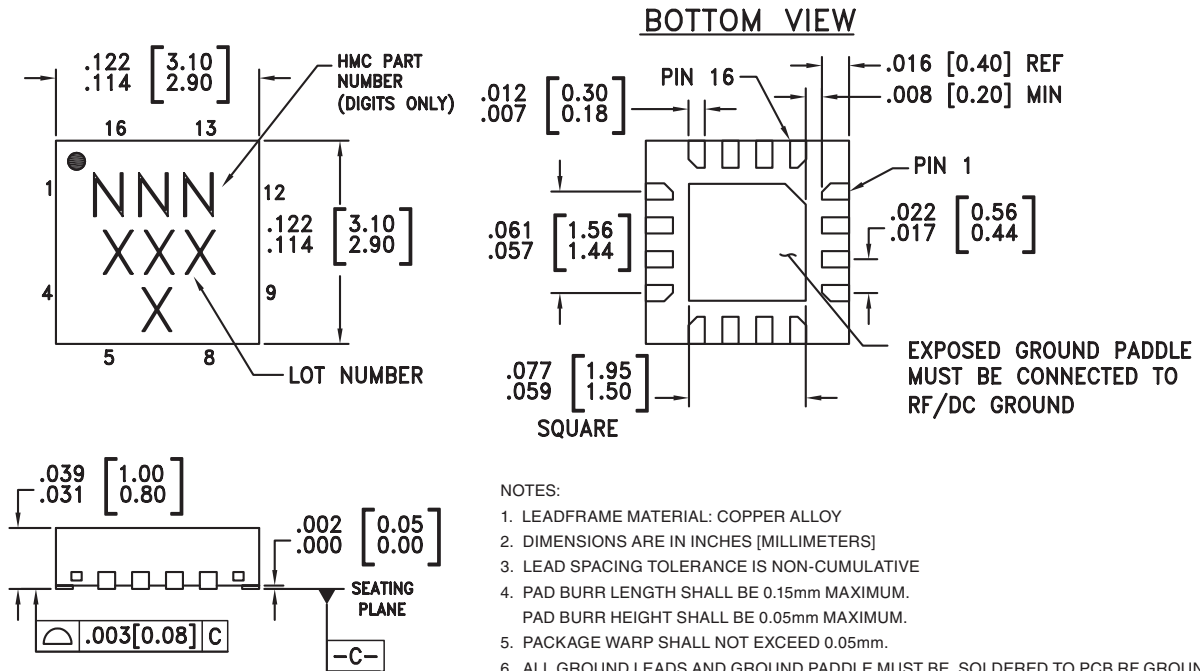

Package Information

Part Number	Package Body Material	Lead Finish	MSL Rating	Package Marking ^[3]
HMC372LP3	Low Stress Injection Molded Plastic	Sn/Pb Solder	MSL1 ^[1]	H372 XXXX
HMC372LP3E	RoHS-compliant Low Stress Injection Molded Plastic	100% matte Sn	MSL1 ^[2]	H372 XXXX



[1] Max peak reflow temperature of 235 °C

[2] Max peak reflow temperature of 260 °C

[3] 4-Digit lot number XXXX

For price, delivery, and to place orders, please contact Hittite Microwave Corporation:
20 Alpha Road, Chelmsford, MA 01824 Phone: 978-250-3343 Fax: 978-250-3373
Order On-line at www.hittite.com

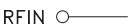
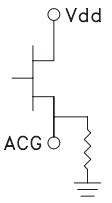
Pin Descriptions

Pin Number	Function	Description	Interface Schematic
1, 5, 8, 9	N/C	No connection necessary. These pins may be connected to RF/DC ground.	
2, 4, 6, 10, 12, 13, 14, 16	GND	These pins must be connected to RF/DC ground.	
3	RF IN	This pin is matched to 50 Ohms with a 22 nH inductor to ground. See Application Circuit.	
7, 15	ACG	AC Ground - An external capacitor of 0.01μF to ground is required for low frequency bypassing. See Application Circuit for further details.	
	Vdd	Power supply voltage. Choke inductor and bypass capacitor are required. See application circuit.	
11	RF OUT	This pin is AC coupled and matched to 50 Ohms.	

Application Circuit

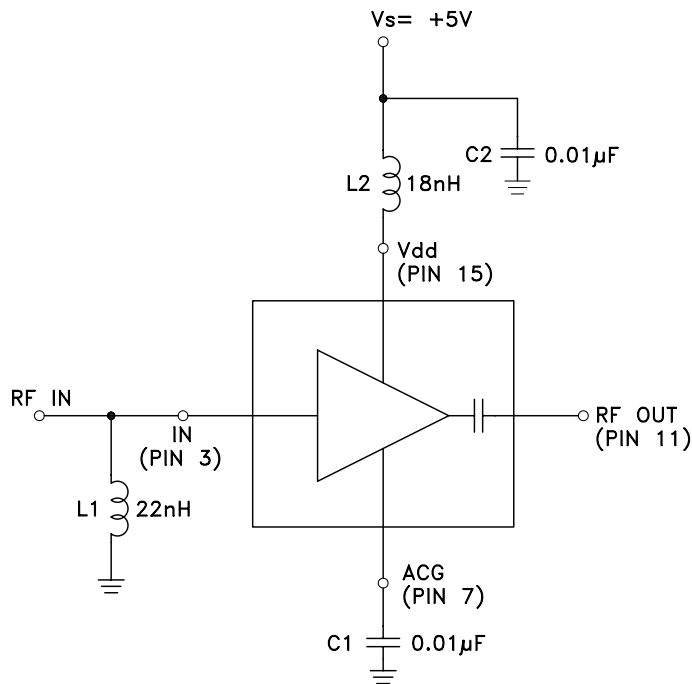

Note 1: Choose value of capacitor C1 for low frequency bypassing. A 0.01 μF ±10% capacitor is recommended.
 Note 2: L1, L2 and C1 should be located as close to the pins as possible.

HMC372LP3 / 372LP3E

GaAs PHEMT MMIC LOW NOISE AMPLIFIER, 700 - 1000 MHz

Evaluation PCB

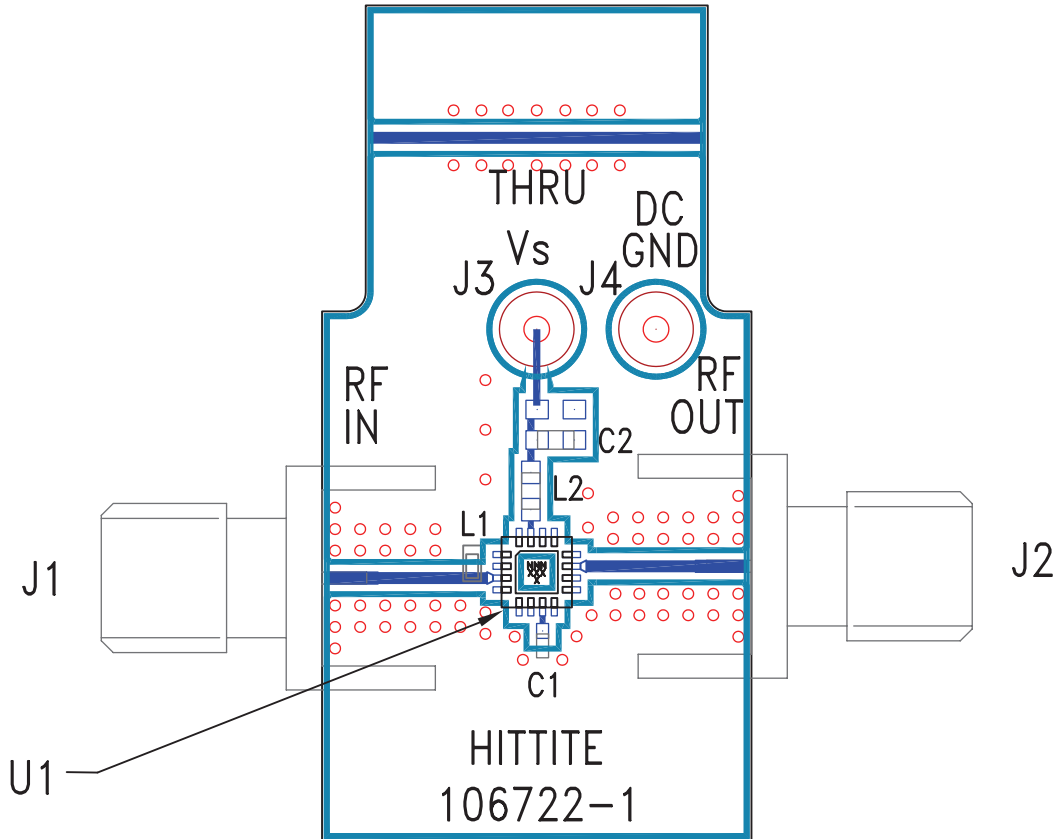

List of Materials for Evaluation PCB 106821 [1]

Item	Description
J1 - J2	PCB Mount SMA RF Connector
J3 - J4	DC Pin
C1	10000 pF Capacitor, 0402 Pkg.
C2	10000 pF Capacitor, 0060 Pkg.
L1	22nH Inductor, 0402 Pkg.
L2	18nH Inductor, 0603 Pkg.
U1	HMC372LP3 / HMC372LP3E Amplifier
PCB [2]	106722 Eval Board

The circuit board used in the final application should use RF circuit design techniques. Signal lines should have 50 ohm impedance while the package ground leads and exposed paddle should be connected directly to the ground plane similar to that shown. A sufficient number of VIA holes should be used to connect the top and bottom ground planes. The evaluation circuit board shown is available from Hittite upon request.

[1] Reference this number when ordering complete evaluation PCB

[2] Circuit Board Material: Rogers 4350



MICROWAVE CORPORATION v02.0605



Notes:

HMC372LP3 / 372LP3E

**GaAs PHEMT MMIC LOW NOISE
AMPLIFIER, 700 - 1000 MHz**