

**1.1MHz, 650mA SYNCHRONOUS DC-DC BUCK CONVERTER AP3406**

## General Description

The AP3406 is a 1.1MHz fixed frequency, current mode, PWM synchronous buck (step-down) DC-DC converter, capable of driving a 650mA load with high efficiency, excellent line and load regulation. The device integrates a main switch and a synchronous switch without an external Schottky diode. It is ideal for powering portable equipment that runs from a single Li-ion battery.

A standard series of inductors are available from several different manufacturers optimized for use with the AP3406. This feature greatly simplifies the design of switch-mode power supplies.

This IC is available in TSOT-23-5 and SOT-23-5 packages.

## Features

- High Efficiency: up to 95%
- Output Current: 650mA
- Input Voltage Range: 2.5V to 5.5V
- Fixed 1.1MHz Frequency
- Current Mode Control
- 100% Duty Cycle in Dropout
- Built-in Short Circuit Protection
- Built-in Thermal Shutdown Function
- Built-in Current Limit Function
- Shutdown Current:  $<1\mu\text{A}$

## Applications

- GPS
- WiFi Card
- Portable Media Player
- Digital Still and Video Cameras

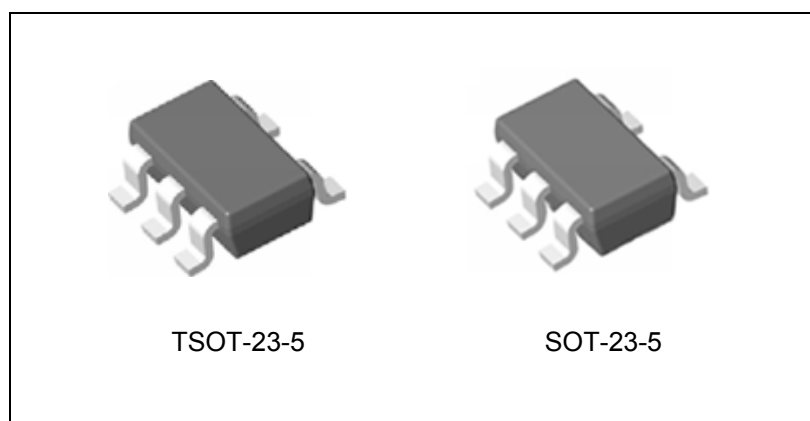

Figure 1. Package Types of AP3406

**1.1MHz, 650mA SYNCHRONOUS DC-DC BUCK CONVERTER AP3406**

## Pin Configuration

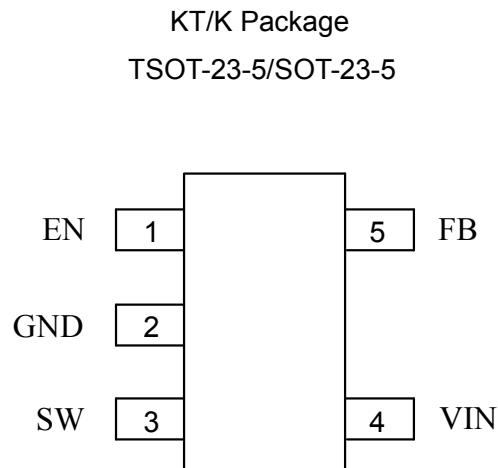

Figure 2. Pin Configuration of AP3406 (Top View)

## Pin Description

Pin Number	Pin Name	Function
1	EN	Control input pin. Forcing this pin above 1.5V enables the IC. Forcing this pin below 0.6V shuts down the IC. When the IC is in shutdown mode, all functions are disabled to decrease the supply current below 1 $\mu$ A
2	GND	Ground pin
3	SW	Power switch output pin. Inductor connection to drain of the internal PFET and NFET switches
4	VIN	Supply input pin. Bypass to GND with a 4.7 $\mu$ F or greater ceramic capacitor
5	FB	Feedback pin. Connect it with an external resistor divider network to program the system output voltage

**1.1MHz, 650mA SYNCHRONOUS DC-DC BUCK CONVERTER AP3406**

**Functional Block Diagram**

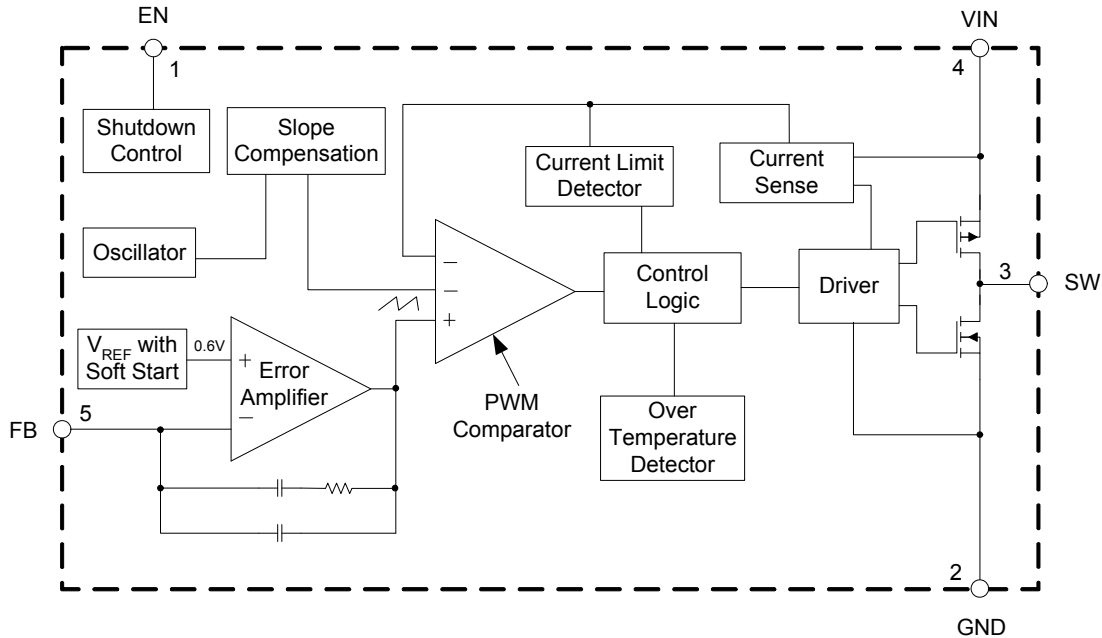
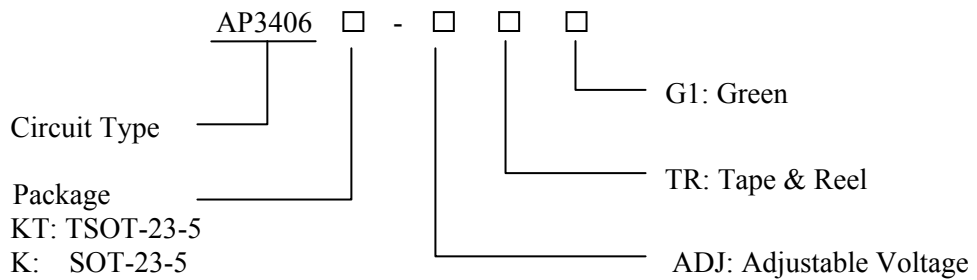

Figure 3. Functional Block Diagram of AP3406

**Ordering Information**



Package	Temperature Range	Part Number	Marking ID	Packing Type
		Green	Green	
TSOT-23-5	-40 to 85°C	AP3406KT-ADJTRG1	L1B	Tape & Reel
SOT-23-5	-40 to 85°C	AP3406K-ADJTRG1	FBC	Tape & Reel

BCD Semiconductor's Pb-free products, as designated with "G1" suffix in the part number, are RoHS compliant and green.

**1.1MHz, 650mA SYNCHRONOUS DC-DC BUCK CONVERTER AP3406****Absolute Maximum Ratings (Note 1)**

Parameter	Symbol	Value		Unit
Input Voltage	$V_{IN}$	-0.3 to 6		V
Feedback Voltage	$V_{FB}$	-0.3 to $V_{IN} + 0.3$		V
EN Pin Voltage	$V_{EN}$	-0.3 to $V_{IN} + 0.3$		V
SW Pin Voltage	$V_{SW}$	-0.3 to $V_{IN} + 0.3$		V
Thermal Resistance	$\theta_{JA}$	TSOT-23-5	250	°C/W
		SOT-23-5	265	
Operating Junction Temperature	$T_J$	125		°C
Storage Temperature	$T_{STG}$	-65 to 150		°C
Lead Temperature (Soldering, 10sec)	$T_{LEAD}$	260		°C

Note 1: Stresses greater than those listed under “Absolute Maximum Ratings” may cause permanent damage to the device. These are stress ratings only, and functional operation of the device at these or any other conditions beyond those indicated under “Recommended Operating Conditions” is not implied. Exposure to “Absolute Maximum Ratings” for extended periods may affect device reliability.

**Recommended Operating Conditions**

Parameter	Symbol	Min	Max	Unit
Input Voltage	$V_{IN}$	2.5	5.5	V
Maximum Output Current	$I_{OUT(MAX)}$	650		mA
Operating Ambient Temperature	$T_A$	-40	85	°C



**1.1MHz, 650mA SYNCHRONOUS DC-DC BUCK CONVERTER AP3406**

**Electrical Characteristics**

$V_{IN}=V_{EN}=3.6V$ ,  $T_A=25^{\circ}C$ , unless otherwise specified. Specifications with **boldface type** apply over full operating temperature range from  $-40$  to  $85^{\circ}C$ .

Parameters	Symbol	Conditions	Min	Typ	Max	Unit
Supply Current	$I_{CC}$	$V_{FB}=0.55V$		400	600	$\mu A$
Shutdown Supply Current	$I_{SHDN}$	$V_{EN}=0V$ , $V_{IN}=5.5V$		0.01	1	$\mu A$
Under Voltage Lockout Threshold	$V_{UVLO}$	Rising edge		2.27		V
Under Voltage Lockout Hysteresis	$V_{HUVLO}$			200		mV
Feedback Bias Current	$I_{FB}$	$V_{FB}=0.65V$	-50	0.5	50	nA
Feedback Voltage	$V_{FB}$	$I_{OUT}=100mA$	0.588/ <b>0.582</b>	0.600	0.612/ <b>0.618</b>	V
Maximum Output Current	$I_{OUT(MAX)}$	$V_{IN}=2.5V$ , $V_{OUT}=0.9V$	650			mA
		$V_{IN}=3.6V$ , $V_{OUT}=1.2V$	650			
		$V_{IN}=4.6V$ , $V_{OUT}=3.3V$	650			
Switch Current Limit	$I_{LIM}$	$V_{FB}=0.55V$	0.8	1.15		A
Oscillator Frequency	$f_{OSC}$		0.8	1.1	1.4	MHz
EN Pin Threshold	$V_{ENL}$				0.6	V
	$V_{ENH}$		1.5			
EN Pin Input Leakage Current	$I_H$	$V_{EN}=3.6V$	-0.1		0.1	$\mu A$
	$I_L$	$V_{EN}=0V$	-0.1		0.1	$\mu A$
Internal PFET On Resistance	$R_{DSONP}$	$I_{SW}=100mA$		0.44		$\Omega$
Internal NFET On Resistance	$R_{DSONN}$	$I_{SW}=-100mA$		0.29		$\Omega$
Maximum Duty Cycle	$D_{MAX}$	$V_{FB}=0.55V$		100		%
Soft-start Time	$T_{SS}$	$V_{EN}=0V$ to $V_{IN}$ $I_{OUT}=50mA$		220		$\mu s$
Thermal Shutdown Threshold	$T_{OTSD}$			160		$^{\circ}C$
Thermal Shutdown Hysteresis	$T_{HYS}$			30		$^{\circ}C$
Thermal Resistance (Junction to Case)	$\theta_{JC}$	SOT-23-5		70		$^{\circ}C/W$
		TSOT-23-5		70		

**1.1MHz, 650mA SYNCHRONOUS DC-DC BUCK CONVERTER AP3406**

**Typical Performance Characteristics**

$L=10\mu\text{H}$ ,  $C_{\text{OUT}}=10\mu\text{F}$ ,  $T_A=25^\circ\text{C}$ , unless otherwise noted.

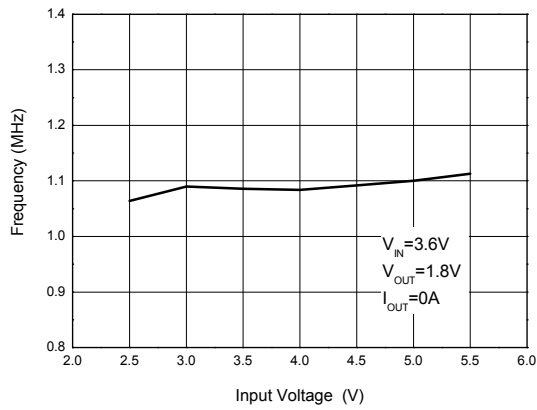

Figure 4. Frequency vs. Input Voltage

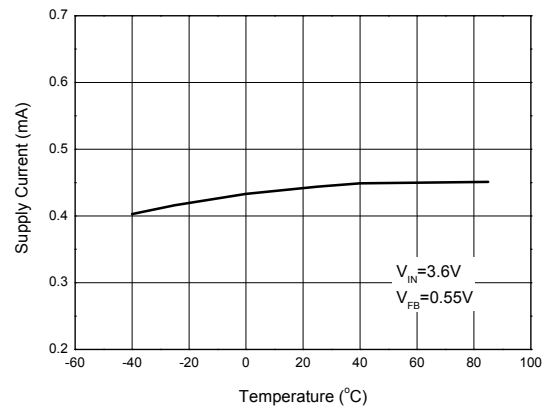

Figure 5. Supply Current vs. Temperature

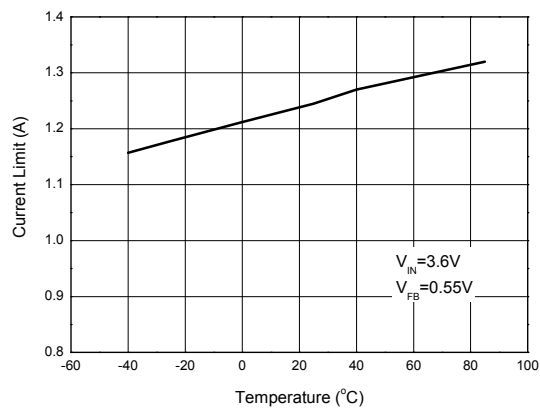

Figure 6. Current Limit vs. Temperature

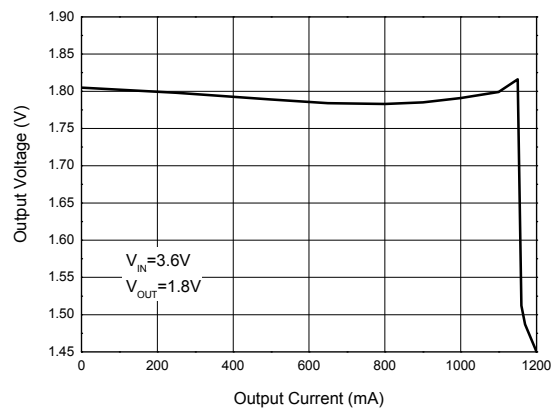
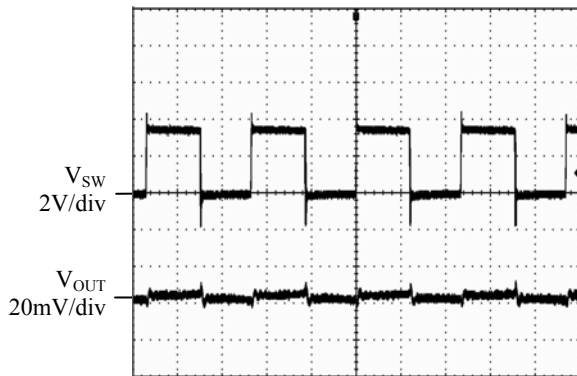

Figure 7. Output Voltage vs. Output Current

**1.1MHz, 650mA SYNCHRONOUS DC-DC BUCK CONVERTER AP3406**
**Typical Performance Characteristics (Continued)**

400ns/div

Figure 8. Light Load Operation  
 ( $V_{in}=3.6V$ ,  $V_{out}=1.8V$ ,  $I_{out}=0mA$ )



400ns/div

Figure 9. Heavy Load Operation  
 ( $V_{in}=3.6V$ ,  $V_{out}=1.8V$ ,  $I_{out}=600mA$ )

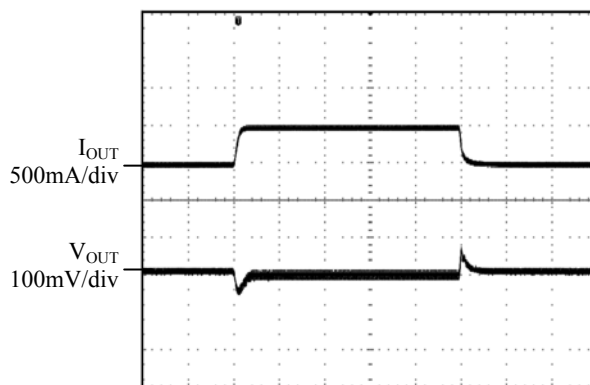

200μs/div

Figure 10. Load Transient  
 ( $V_{in}=3.6V$ ,  $V_{out}=1.8V$ ,  $I_{out}=0mA$  to 500mA)

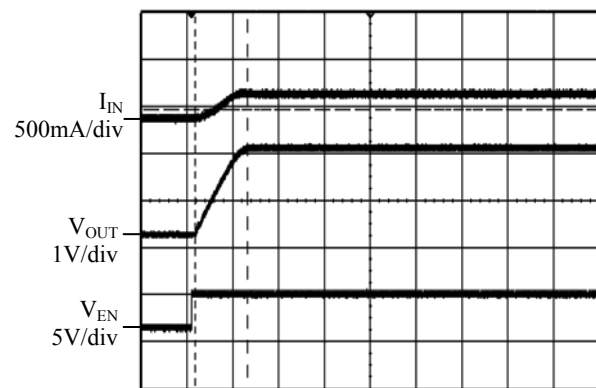

200μs/div

Figure 11. Start up from Shutdown  
 ( $V_{in}=3.6V$ ,  $V_{out}=1.8V$ ,  $R_{load}=4\Omega$ )

**1.1MHz, 650mA SYNCHRONOUS DC-DC BUCK CONVERTER AP3406**

**Typical Performance Characteristics (Continued)**

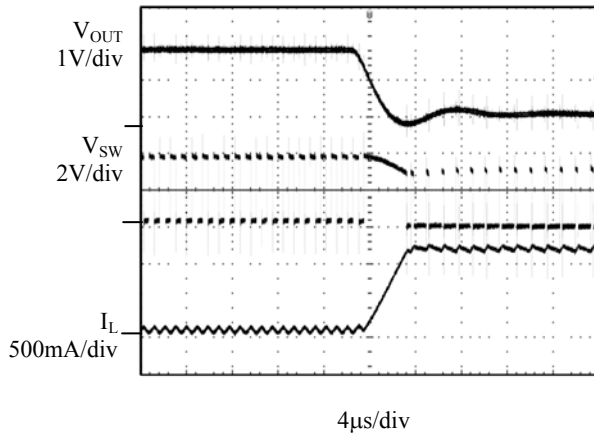

Figure 12. Short Circuit Protection  
( $V_{IN}=3.6V$ ,  $V_{OUT}=1.8V$ , no load)

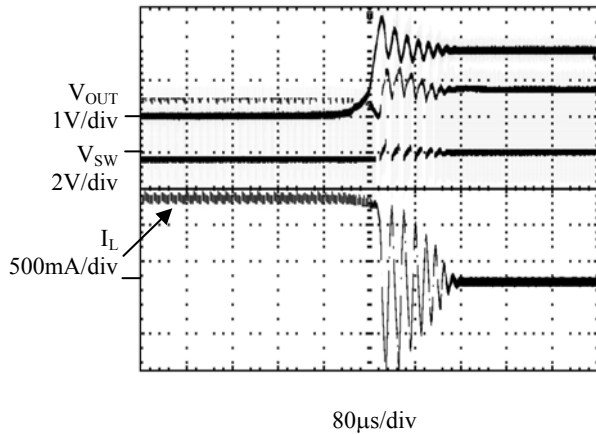

Figure 13. Short Circuit Recovery  
( $V_{IN}=3.6V$ ,  $V_{OUT}=1.8V$ , no load)

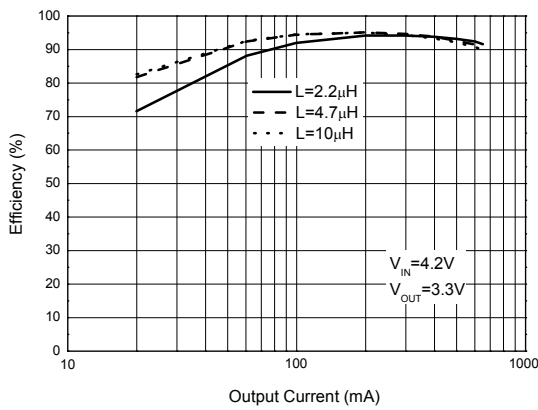

Figure 14. Efficiency vs. Output Current

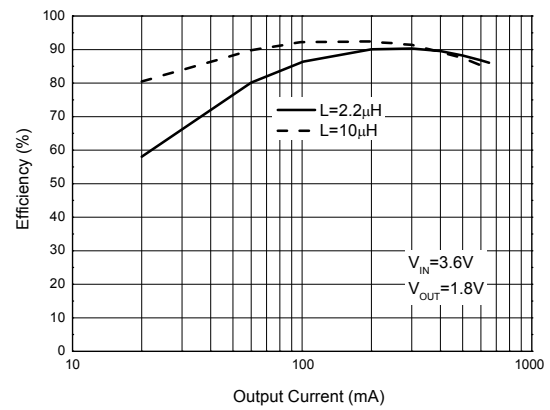

Figure 15. Efficiency vs. Output Current



**1.1MHz, 650mA SYNCHRONOUS DC-DC BUCK CONVERTER AP3406**
**Typical Performance Characteristics (Continued)**

Figure 16. Normalized Feedback Voltage vs. Temperature

**Typical Application**

Figure 17. Typical Application of AP3406

**1.1MHz, 650mA SYNCHRONOUS DC-DC BUCK CONVERTER AP3406**

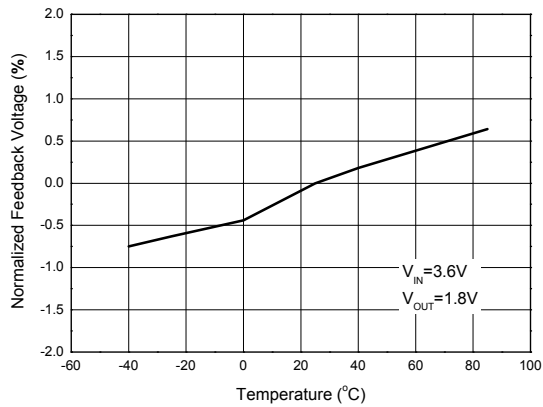
**Mechanical Dimensions**

**SOT-23-5**

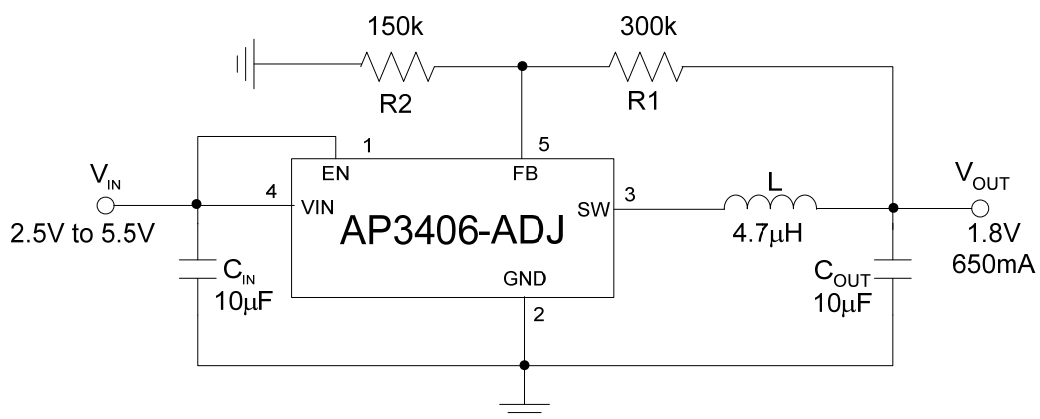
**Unit: mm(inch)**

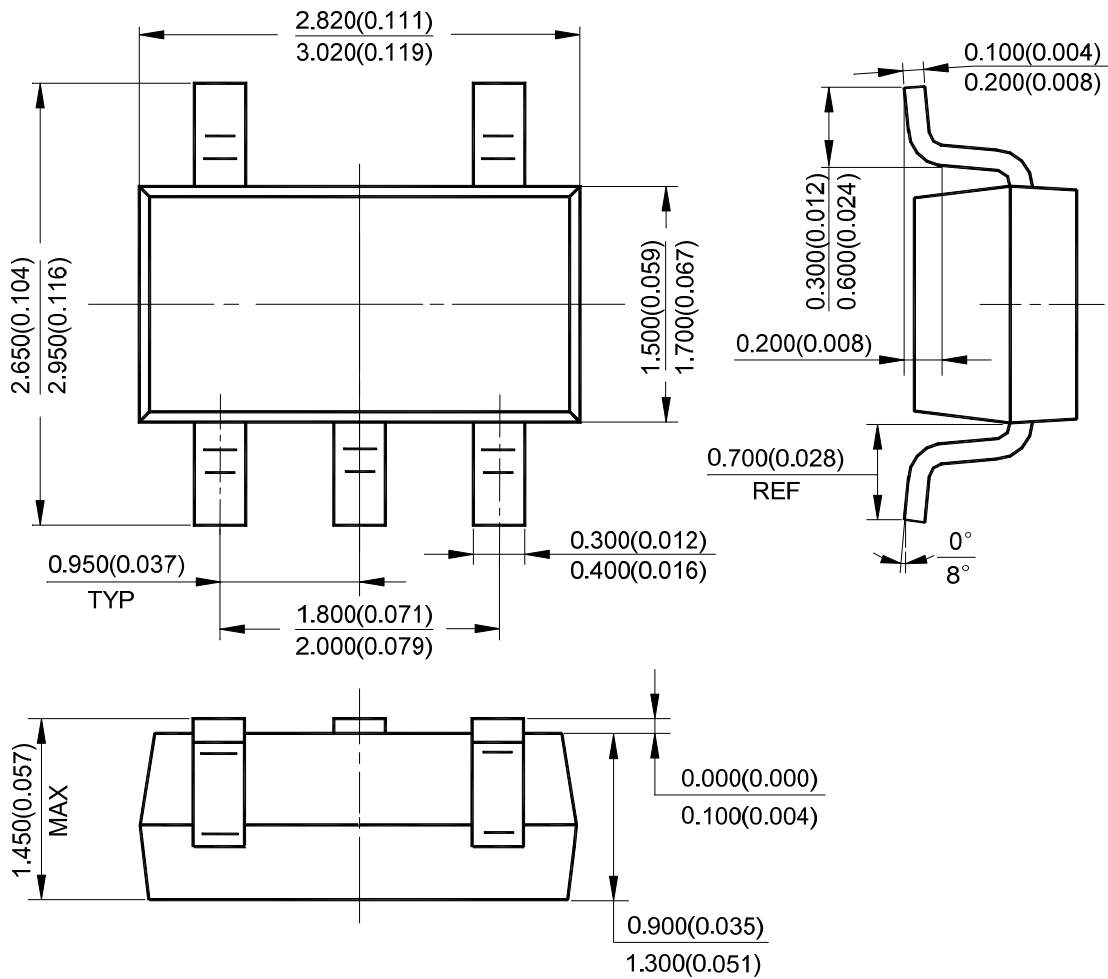

**1.1MHz, 650mA SYNCHRONOUS DC-DC BUCK CONVERTER AP3406**

**Mechanical Dimensions (Continued)**

**TSOT-23-5**

**Unit: mm(inch)**

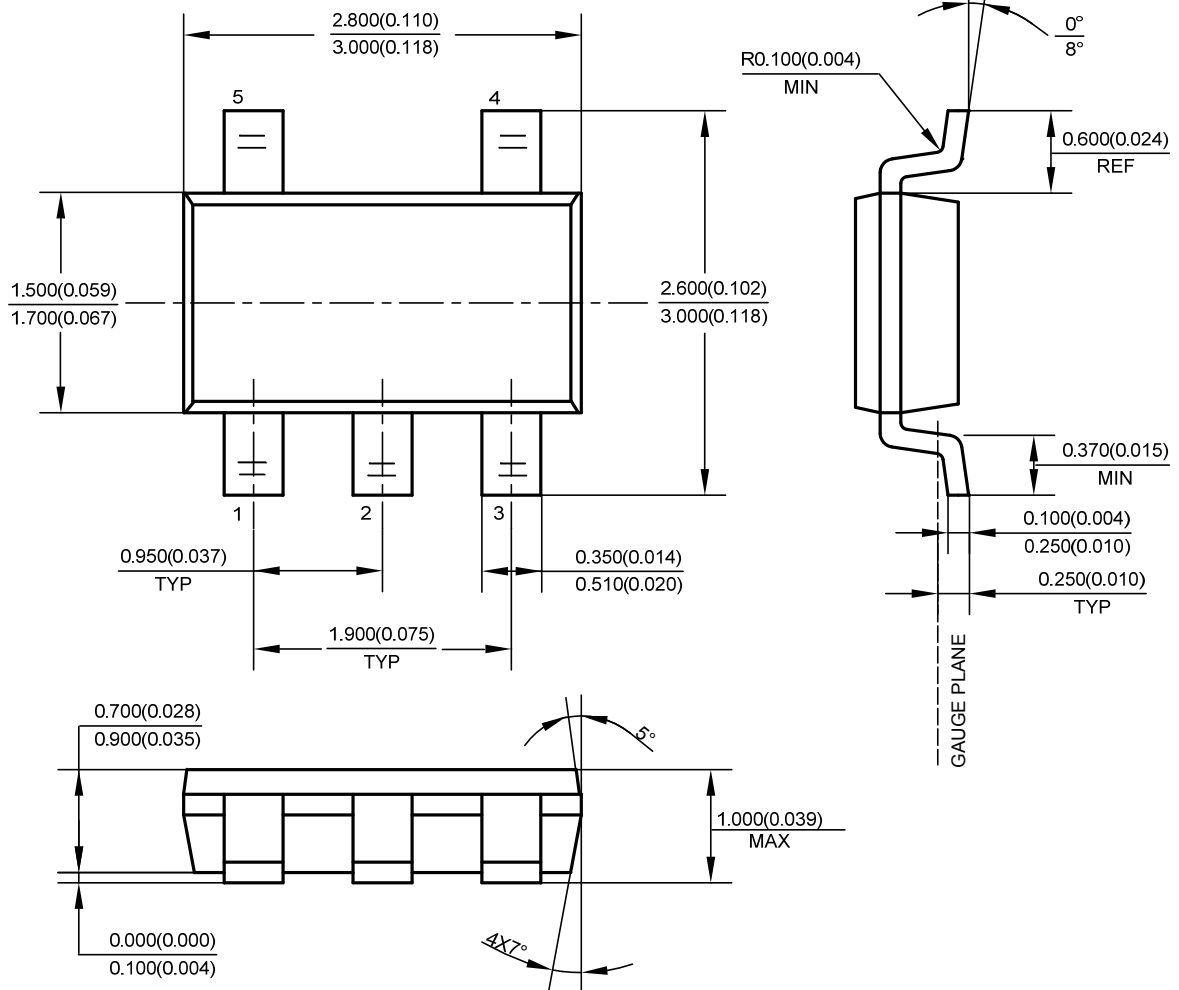



## **BCD Semiconductor Manufacturing Limited**

<http://www.bcdsemi.com>

### **IMPORTANT NOTICE**

BCD Semiconductor Manufacturing Limited reserves the right to make changes without further notice to any products or specifications herein. BCD Semiconductor Manufacturing Limited does not assume any responsibility for use of any its products for any particular purpose, nor does BCD Semiconductor Manufacturing Limited assume any liability arising out of the application or use of any its products or circuits. BCD Semiconductor Manufacturing Limited does not convey any license under its patent rights or other rights nor the rights of others.

---

#### **MAIN SITE**

##### **- Headquarters**

##### **BCD Semiconductor Manufacturing Limited**

No. 1600, Zi Xing Road, Shanghai Zizhu Science-based Industrial Park, 200241, China  
Tel: +86-21-24162266, Fax: +86-21-24162277

##### **- Wafer Fab**

##### **Shanghai SIM-BCD Semiconductor Manufacturing Co., Ltd.**

800 Yi Shan Road, Shanghai 200233, China  
Tel: +86-21-6485 1491, Fax: +86-21-5450 0008

#### **REGIONAL SALES OFFICE**

##### **Shenzhen Office**

**Shanghai SIM-BCD Semiconductor Manufacturing Co., Ltd., Shenzhen Office**  
Room E, 5F, Noble Center, No.1006, 3rd Fuzhong Road, Futian District, Shenzhen,  
518026, China  
Tel: +86-755-8826 7951  
Fax: +86-755-8826 7865

##### **Taiwan Office**

**BCD Semiconductor (Taiwan) Company Limited**  
4F, 298-1, Rui Guang Road, Nei-Hu District, Taipei,  
Taiwan  
Tel: +886-2-2656 2808  
Fax: +886-2-2656 2806

##### **USA Office**

**BCD Semiconductor Corp.**  
30920 Huntwood Ave. Hayward,  
CA 94544, USA  
Tel : +1-510-324-2988  
Fax: +1-510-324-2788