

Standard type with small dimensions

Construction

- Charge-discharge proof, polar
- Aluminum case with insulating sleeve
- Negative pole connected to case
- Axial leads, welded to ensure perfect electrical contact

Features

- Standard type with small dimensions
- Operation at temperatures up to 105 °C¹⁾
- Good electrical characteristics
- High ripple current capability

Applications

- For general-purpose applications in entertainment electronics
- Semi-professional to professional application range
- For filtering, coupling and pulse circuits

Tape packaging

Capacitors with $d \leq 16$ mm are also available on tape.

Refer to [page 305](#) for information on tapes and examples on how to order them.

Specifications and characteristics in brief

Rated voltage U_R	6,3 to 100 V–	
Surge voltage U_S	$1,15 \cdot U_R$	
Rated capacitance C_R	4,7 to 10 000 μ F	
Capacitance tolerance	– 10/+ 50 % \triangleq T	
Useful life	$d \leq 10$ mm	$d \geq 12$ mm
	40 °C, U_R 85 °C, U_R ; $I_{\sim\max}$	> 200 000 h ($I_{\sim,85^\circ\text{C}}$) > 3 000 h
Failure percentage	≤ 1 % (during useful life)	
Failure rate (1 fit = $1 \cdot 10^{-9}$ /h)	$d \leq 10$ mm: ≤ 100 fit	
	$d \geq 12$ mm: ≤ 40 fit	
Voltage endurance test	2 000 h, 85 °C (at U_R)	
Leakage current I_{lka} (5 min, 20 °C)		
	$I_{lka} \leq 0,3 \mu\text{A} \cdot \left(\frac{C_R}{\mu\text{F}} \cdot \frac{U_R}{\text{V}} \right)^{0,7} + 4 \mu\text{A}$	

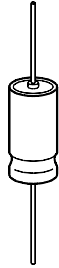

KAL0277–Z

1) Operation at 105 °C and 0,6 $I_{\sim,85^\circ\text{C}}$ permissible for a total of 500 h.



Specifications and characteristics in brief

Self-inductance L_{ESL}	d (mm)	6,5	8,5	10	12	14	16	18	21	25	
	l (mm)	15,5	15,5	25	30	30	30	39,5	40	40	
	L_{ESL} approx. (nH)	14	17	35	37	38	45	57	30	34	
IEC climatic category	in accordance with IEC 68-1 40/085/56 (−40 °C/+85 °C, 56 days damp heat test)										
Detail specifications	similar to CECC 30 301-044 (similar to DIN 45 910 part 126)										
Sectional specifications	IEC 384-4 (DIN 45 910 part 12)										
Vibration resistance	in accordance with IEC 68-2-6, test Fc: displacement amplitude 0,35 mm, frequency range 10 to 55 Hz, acceleration max. 5 g, duration 3 × 2 h										

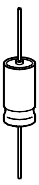

B 41 010
B 41 283

Outline drawing

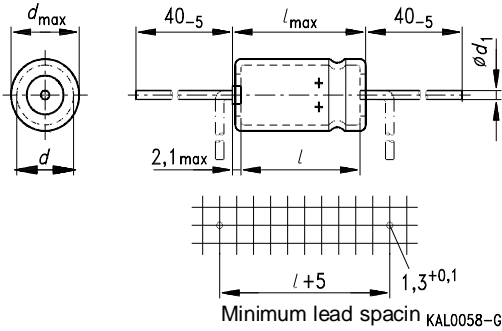

Type	Dimensions (mm)		Lead wire diameter d_1	Approximate weight (g)
	$d \times l$	$d_{max} \times l_{max}$		
B 41 283	6,5 × 15,5	7,0 × 17	0,6	1,1
	8,5 × 15,5	9,0 × 17		1,8
	10 × 25	10,5 × 26,5		3,2
B 41 010	12 × 30	12,5 × 32	0,8	5,4
	14 × 30	14,5 × 32		7,5
	16 × 30	16,5 × 32		9,3
	18 × 39,5	18,5 × 40,3		14
	21 × 40	21,5 × 41,5		18
	25 × 40	25,5 × 41,5		26

Packing units

Case dimensions $d \times l$ (mm)	Bulk PU (pcs.)	Reel packing PU (pcs./reel)
6,5 × 15,5	2000	1300
8,5 × 15,5	1500	1000
10 × 25	900	600
12 × 30	600	450
14 × 30	400	350
16 × 30	350	250
18 × 39,5	250	–
21 × 40	200	–
25 × 40	150	–

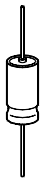

Overview of available types

U_R (V-)	6,3	10	16	25	40	63	100
C_R (μF)	Case dimensions $d \times l$ (mm)						
4,7							6,5 × 15,5
10						6,5 × 15,5	8,5 × 15,5
22					6,5 × 15,5	8,5 × 15,5	8,5 × 15,5
47				6,5 × 15,5	8,5 × 15,5	8,5 × 15,5	10 × 25
100		6,5 × 15,5	8,5 × 15,5	8,5 × 15,5	10 × 25	10 × 25	12 × 30
220		8,5 × 15,5	8,5 × 15,5	10 × 25	10 × 25	12 × 30	16 × 30
470	8,5 × 15,5	10 × 25	10 × 25	12 × 30	12 × 30	16 × 30	21 × 40
1 000	10 × 25	12 × 30	12 × 30	14 × 30	16 × 30	21 × 40	
2 200	12 × 30	14 × 30	16 × 30	18 × 39,5	21 × 40		
4 700	16 × 30	18 × 39,5	21 × 40	25 × 40			
10 000		25 × 40					

The above capacitance and voltage ratings are available in smaller cases upon request. Other voltage and capacitance ratings are also available upon request.



B 41 010
B 41 283

Technical data and ordering codes

U_R	C_R	Case dimensions $d \times l$ mm	$R_{ESR, typ}$ 100 Hz 20 °C mΩ	$R_{ESR, max}$ 100 Hz 20 °C mΩ	Z_{max} 10 kHz 20 °C mΩ	I_{-R} 100 Hz 40 °C A	I_{-max} 100 Hz 85 °C A	Ordering code ¹⁾ Short code
B41283- ($d \leq 10$ mm), B41010- ($d \geq 12$ mm)								
6,3	470	8,5 × 15,5	0,44	0,75	0,46	0,73	0,25	-D2477-T90
	1 000	10 × 25	0,24	0,35	0,22	1,2	0,42	-B2108-T90
	2 200	12 × 30	0,12	0,19	0,10	2,1	0,71	-B2228-T
	4 700	16 × 30	0,08	0,11	0,05	3,2	1,1	-E2478-T
10	100	6,5 × 15,5	1,5	3,2	1,7	0,35	0,12	-C3107-T90
	220	8,5 × 15,5	0,65	1,4	0,79	0,61	0,21	-D3227-T90
	470	10 × 25	0,32	0,68	0,37	1,0	0,36	-B3477-T90
	1 000	12 × 30	0,18	0,32	0,16	1,7	0,57	-A3108-T
	2 200	14 × 30	0,19	0,18	0,08	2,3	0,81	-C3228-T
	4 700	18 × 39,5	0,06	0,10	0,05	4,1	1,4	-C3478-T
	10 000	25 × 40	0,05	0,07	0,05	5,5	1,9	-C3109-T
16	100	8,5 × 15,5	1,3	2,8	1,4	0,41	0,14	-C4107-T90
	220	8,5 × 15,5	0,58	1,3	0,65	0,61	0,21	-C4227-T90
	470	10 × 25	0,27	0,60	0,30	1,1	0,39	-B4477-T90
	1 000	12 × 30	0,15	0,28	0,13	1,8	0,63	-B4108-T
	2 200	16 × 30	0,09	0,16	0,06	2,7	0,93	-E4228-T
	4 700	21 × 40	0,06	0,09	0,05	4,4	1,5	-C4478-T
25	47	6,5 × 15,5	2,4	5,3	2,1	0,26	0,09	-C5476-T90
	100	8,5 × 15,5	1,0	2,5	1,0	0,46	0,16	-C5107-T90
	220	10 × 25	0,44	1,1	0,45	0,81	0,28	-C5227-T90
	470	12 × 30	0,21	0,53	0,19	1,5	0,53	-B5477-T
	1 000	14 × 30	0,12	0,25	0,09	2,1	0,74	-C5108-T
	2 200	18 × 39,5	0,07	0,14	0,05	3,8	1,3	-C5228-T
	4 700	25 × 40	0,05	0,09	0,05	5,2	1,8	-C5478-T

1) For instructions on how to determine ordering codes, refer to [page 273](#).



Technical data and ordering codes

U_R	C_R	Case dimensions $d \times l$ mm	$R_{ESR, typ}$ 100 Hz 20 °C mΩ	$R_{ESR, max}$ 100 Hz 20 °C mΩ	Z_{max} 10 kHz 20 °C mΩ	I_{-R} 100 Hz 40 °C A	I_{-max} 100 Hz 85 °C A	Ordering code ¹⁾ Short code
B41283- ($d \leq 10$ mm), B41010- ($d \geq 12$ mm)								
40	22	6,5 × 15,5	4,0	8,0	3,6	0,20	0,07	-C7226-T90
	47	8,5 × 15,5	1,5	3,8	1,7	0,38	0,13	-E7476-T90
	100	10 × 25	0,7	1,8	0,80	0,64	0,22	-C7107-T90
	220	10 × 25	0,36	0,80	0,36	0,96	0,33	-A7227-T
	470	12 × 30	0,18	0,38	0,15	1,7	0,57	-B7477-T
	1 000	16 × 30	0,10	0,18	0,08	2,6	0,88	-E7108-T
	2 200	21 × 40	0,07	0,11	0,05	4,1	1,4	-C7228-T
63	10	6,5 × 15,5	5,0	13	6,0	0,17	0,06	-B8106-T90
	22	8,5 × 15,5	2,5	6,3	2,7	0,29	0,10	-D8226-T90
	47	8,5 × 15,5	1,2	3,0	1,2	0,44	0,15	-D8476-T90
	100	10 × 25	0,55	1,4	0,60	0,78	0,27	-B8107-T90
	220	12 × 30	0,30	0,64	0,25	1,3	0,44	-B8227-T
	470	16 × 30	0,14	0,30	0,12	2,1	0,74	-D8477-T
	1 000	21 × 40	0,08	0,14	0,06	3,8	1,3	-B8108-T
100	4,7	6,5 × 15,5	9,5	24	10	0,15	0,05	-B9475-T90
	10	8,5 × 15,5	4,0	10	5,0	0,23	0,08	-K9106-T90
	22	8,5 × 15,5	1,8	4,5	2,2	0,35	0,12	-D9226-T90
	47	10 × 25	0,85	2,1	1,0	0,64	0,22	-B9476-T90
	100	12 × 30	0,40	1,0	0,45	1,1	0,38	-B9107-T
	220	16 × 30	0,22	0,55	0,20	1,7	0,59	-E9227-T
	470	21 × 40	0,12	0,26	0,10	2,9	1,0	-B9477-T

1) To obtain the required ordering code, prefix the type number to the short code. E. g.: B41283-B7226-T
B41283-... ($d \leq 10$ mm)
B41010-... ($d \geq 12$ mm)

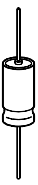

B 41 010
B 41 283

Useful life

versus ambient temperature T_A under ripple current operating conditions¹⁾

B 41 283 ($d \leq 10$ mm)

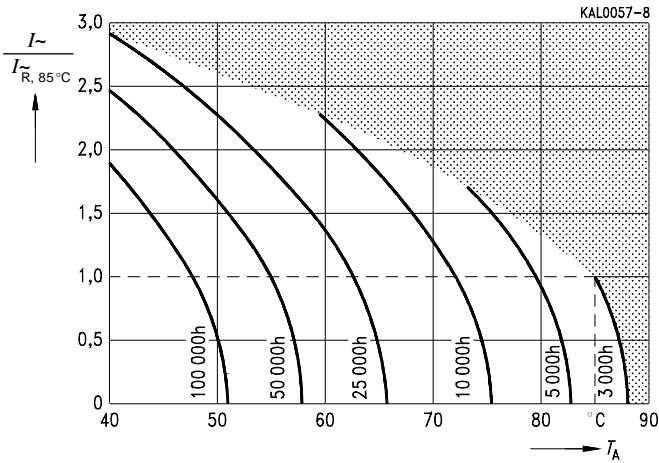

B 41 010 ($d \geq 12$ mm)

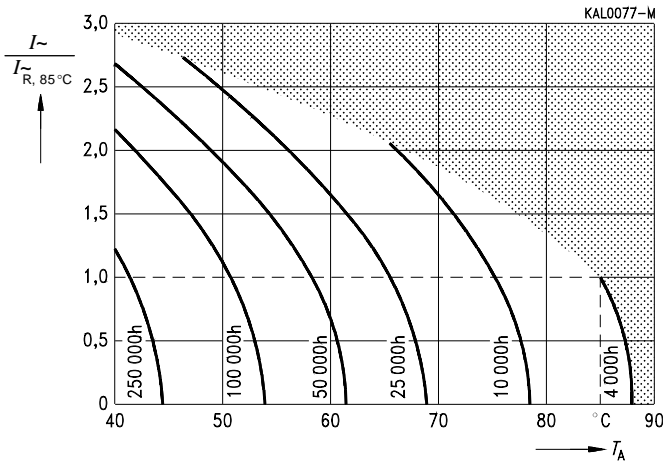

1) Refer to [page 34](#) for an explanation on how to interpret the useful life graphs.

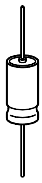

Permissible ripple current I_r versus frequency f

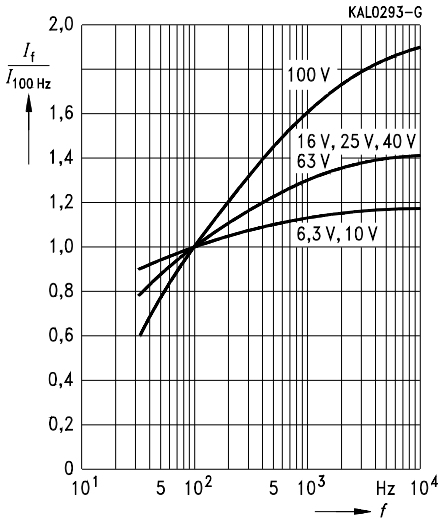

Series capacitance C_S at $f = 100$ Hz versus temperature T
Typical behavior

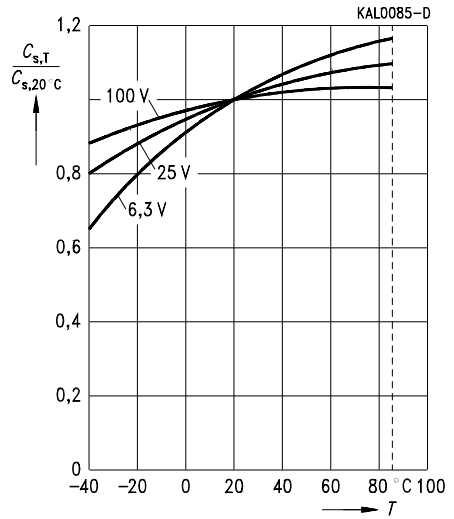

Equivalent series resistance R_{ESR} at $f = 100$ Hz versus temperature T
Typical behavior

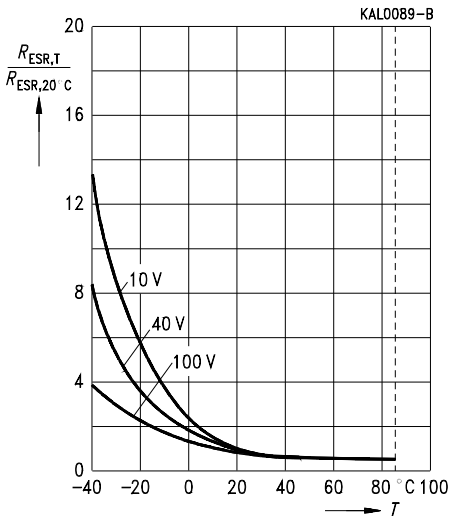

Impedance Z at $f = 10$ kHz versus temperature T
Typical behavior

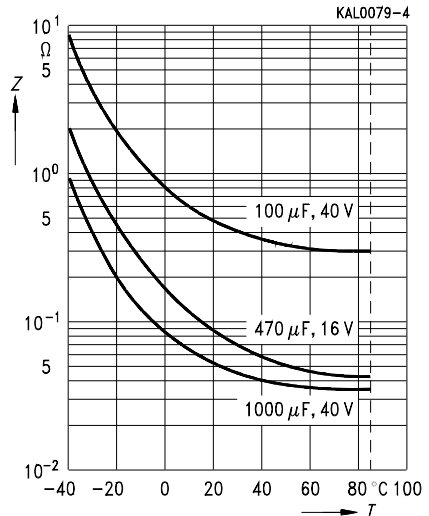

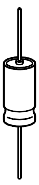

B 41 010
B 41 283

Impedance Z
 versus frequency f
 and temperature T for 470 $\mu\text{F}/16\text{ V}$ –
 Typical behavior

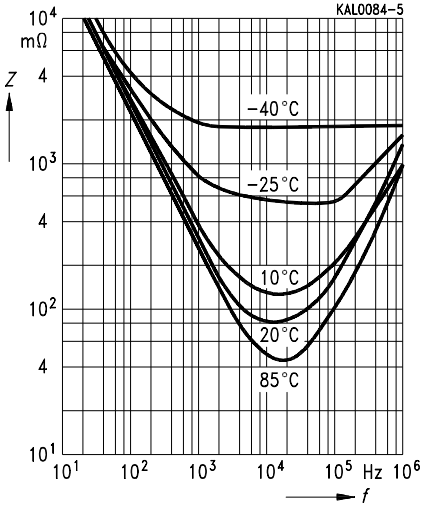

Impedance Z
 versus frequency f
 and temperature T for 1000 $\mu\text{F}/40\text{ V}$ –
 Typical behavior

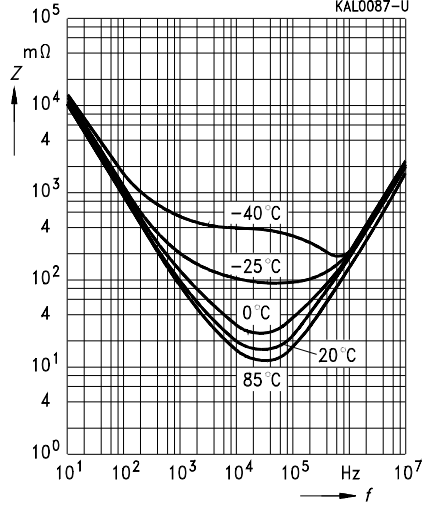

Impedance Z
 versus frequency f
 Typical values at 20 °C
 $U_R \leq 100\text{ V}$ –

