Features

- High-performance, Low-power AVR[®] 8-bit Microcontroller
- Advanced RISC Architecture
 - 130 Powerful Instructions – Most Single-clock Cycle Execution
 - 32 x 8 General Purpose Working Registers
 - Fully Static Operation
 - Up to 16 MIPS Throughput at 16 MHz
 - On-chip 2-cycle Multiplier
- Nonvolatile Program and Data Memories
 - 8K Bytes of In-System Self-Programmable Flash
Endurance: 10,000 Write/Erase Cycles
 - Optional Boot Code Section with Independent Lock Bits
In-System Programming by On-chip Boot Program
True Read-While-Write Operation
 - 512 Bytes EEPROM
Endurance: 100,000 Write/Erase Cycles
 - 1K Byte Internal SRAM
 - Programming Lock for Software Security
- Peripheral Features
 - Two 8-bit Timer/Counters with Separate Prescaler, one Compare Mode
 - One 16-bit Timer/Counter with Separate Prescaler, Compare Mode, and Capture Mode
 - Real Time Counter with Separate Oscillator
 - Three PWM Channels
 - 8-channel ADC in TQFP and QFN/MLF package
Eight Channels 10-bit Accuracy
 - 6-channel ADC in PDIP package
Eight Channels 10-bit Accuracy
 - Byte-oriented Two-wire Serial Interface
 - Programmable Serial USART
 - Master/Slave SPI Serial Interface
 - Programmable Watchdog Timer with Separate On-chip Oscillator
 - On-chip Analog Comparator
- Special Microcontroller Features
 - Power-on Reset and Programmable Brown-out Detection
 - Internal Calibrated RC Oscillator
 - External and Internal Interrupt Sources
 - Five Sleep Modes: Idle, ADC Noise Reduction, Power-save, Power-down, and Standby
- I/O and Packages
 - 23 Programmable I/O Lines
 - 28-lead PDIP, 32-lead TQFP, and 32-pad QFN/MLF
- Operating Voltages
 - 2.7 - 5.5V (ATmega8L)
 - 4.5 - 5.5V (ATmega8)
- Speed Grades
 - 0 - 8 MHz (ATmega8L)
 - 0 - 16 MHz (ATmega8)
- Power Consumption at 4 Mhz, 3V, 25°C
 - Active: 3.6 mA
 - Idle Mode: 1.0 mA
 - Power-down Mode: 0.5 µA



**8-bit AVR[®]
with 8K Bytes
In-System
Programmable
Flash**

**ATmega8
ATmega8L**





Pin Configurations

PDIP

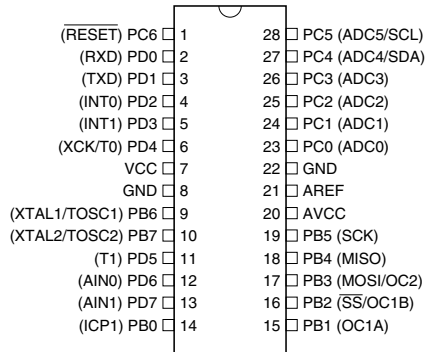

TQFP Top View

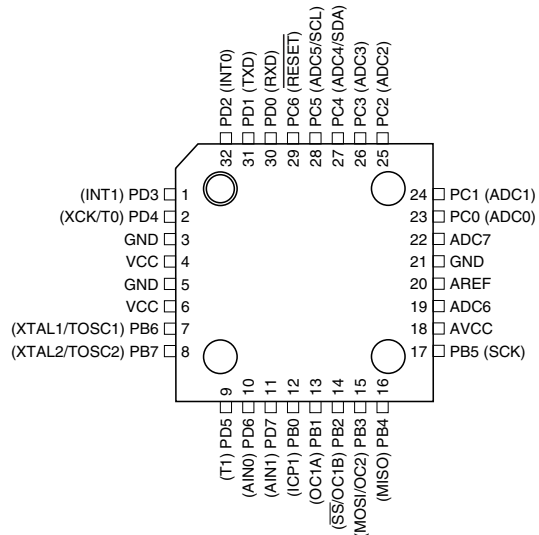

MLF Top View

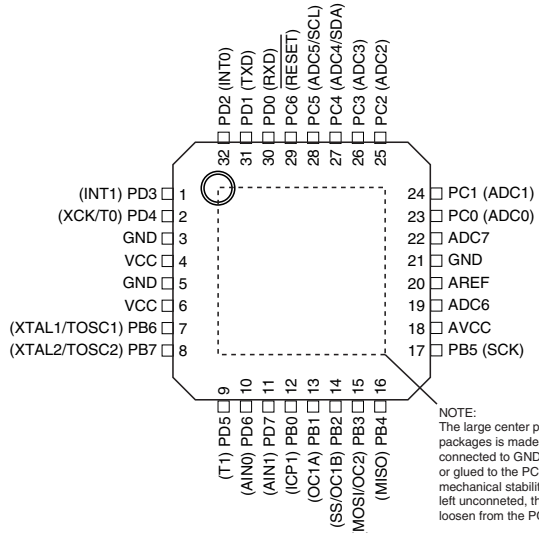

NOTE:
The large center pad underneath the MLF packages is made of metal and internally connected to GND. It should be soldered or glued to the PCB to ensure good mechanical stability. If the center pad is left unconnected, the package might loosen from the PCB.

Overview

The ATmega8 is a low-power CMOS 8-bit microcontroller based on the AVR RISC architecture. By executing powerful instructions in a single clock cycle, the ATmega8 achieves throughputs approaching 1 MIPS per MHz, allowing the system designer to optimize power consumption versus processing speed.

Block Diagram

Figure 1. Block Diagram

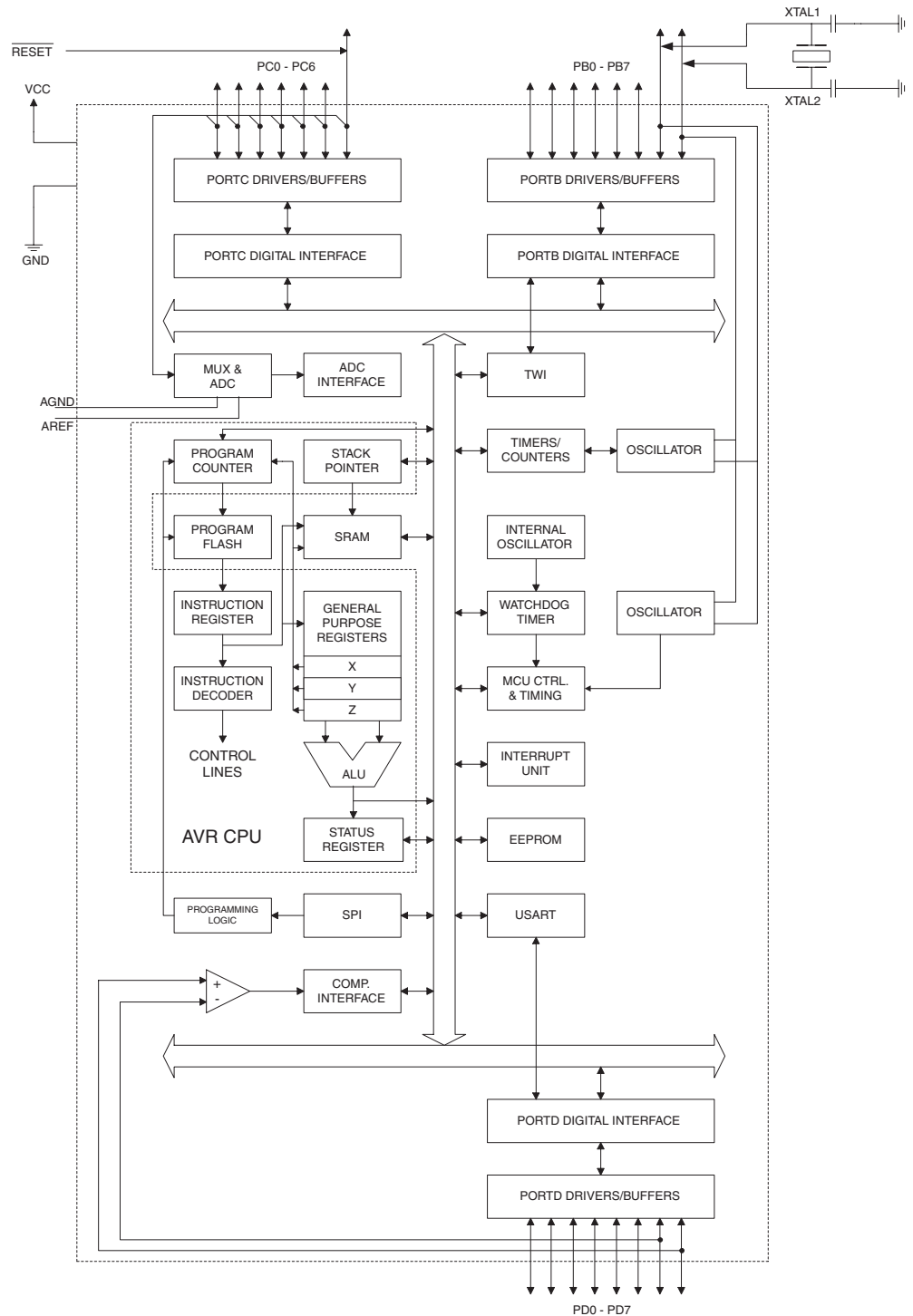



The AVR core combines a rich instruction set with 32 general purpose working registers. All the 32 registers are directly connected to the Arithmetic Logic Unit (ALU), allowing two independent registers to be accessed in one single instruction executed in one clock cycle. The resulting architecture is more code efficient while achieving throughputs up to ten times faster than conventional CISC microcontrollers.

The ATmega8 provides the following features: 8K bytes of In-System Programmable Flash with Read-While-Write capabilities, 512 bytes of EEPROM, 1K byte of SRAM, 23 general purpose I/O lines, 32 general purpose working registers, three flexible Timer/Counters with compare modes, internal and external interrupts, a serial programmable USART, a byte oriented Two-wire Serial Interface, a 6-channel ADC (eight channels in TQFP and QFN/MLF packages) with 10-bit accuracy, a programmable Watchdog Timer with Internal Oscillator, an SPI serial port, and five software selectable power saving modes. The Idle mode stops the CPU while allowing the SRAM, Timer/Counters, SPI port, and interrupt system to continue functioning. The Power-down mode saves the register contents but freezes the Oscillator, disabling all other chip functions until the next Interrupt or Hardware Reset. In Power-save mode, the asynchronous timer continues to run, allowing the user to maintain a timer base while the rest of the device is sleeping. The ADC Noise Reduction mode stops the CPU and all I/O modules except asynchronous timer and ADC, to minimize switching noise during ADC conversions. In Standby mode, the crystal/resonator Oscillator is running while the rest of the device is sleeping. This allows very fast start-up combined with low-power consumption.

The device is manufactured using Atmel's high density non-volatile memory technology. The Flash Program memory can be reprogrammed In-System through an SPI serial interface, by a conventional non-volatile memory programmer, or by an On-chip boot program running on the AVR core. The boot program can use any interface to download the application program in the Application Flash memory. Software in the Boot Flash Section will continue to run while the Application Flash Section is updated, providing true Read-While-Write operation. By combining an 8-bit RISC CPU with In-System Self-Programmable Flash on a monolithic chip, the Atmel ATmega8 is a powerful microcontroller that provides a highly-flexible and cost-effective solution to many embedded control applications.

The ATmega8 AVR is supported with a full suite of program and system development tools, including C compilers, macro assemblers, program debugger/simulators, In-Circuit Emulators, and evaluation kits.

Disclaimer

Typical values contained in this datasheet are based on simulations and characterization of other AVR microcontrollers manufactured on the same process technology. Min and Max values will be available after the device is characterized.

Pin Descriptions

VCC	Digital supply voltage.
GND	Ground.
Port B (PB7..PB0) XTAL1/XTAL2/TOSC1/TOSC2	<p>Port B is an 8-bit bi-directional I/O port with internal pull-up resistors (selected for each bit). The Port B output buffers have symmetrical drive characteristics with both high sink and source capability. As inputs, Port B pins that are externally pulled low will source current if the pull-up resistors are activated. The Port B pins are tri-stated when a reset condition becomes active, even if the clock is not running.</p> <p>Depending on the clock selection fuse settings, PB6 can be used as input to the inverting Oscillator amplifier and input to the internal clock operating circuit.</p> <p>Depending on the clock selection fuse settings, PB7 can be used as output from the inverting Oscillator amplifier.</p> <p>If the Internal Calibrated RC Oscillator is used as chip clock source, PB7..6 is used as TOSC2..1 input for the Asynchronous Timer/Counter2 if the AS2 bit in ASSR is set.</p> <p>The various special features of Port B are elaborated in “Alternate Functions of Port B” on page 58 and “System Clock and Clock Options” on page 25.</p>
Port C (PC5..PC0)	<p>Port C is an 7-bit bi-directional I/O port with internal pull-up resistors (selected for each bit). The Port C output buffers have symmetrical drive characteristics with both high sink and source capability. As inputs, Port C pins that are externally pulled low will source current if the pull-up resistors are activated. The Port C pins are tri-stated when a reset condition becomes active, even if the clock is not running.</p>
PC6/<u>RESET</u>	<p>If the RSTDISBL Fuse is programmed, PC6 is used as an I/O pin. Note that the electrical characteristics of PC6 differ from those of the other pins of Port C.</p> <p>If the RSTDISBL Fuse is unprogrammed, PC6 is used as a Reset input. A low level on this pin for longer than the minimum pulse length will generate a Reset, even if the clock is not running. The minimum pulse length is given in Table 15 on page 38. Shorter pulses are not guaranteed to generate a Reset.</p> <p>The various special features of Port C are elaborated on page 61.</p>
Port D (PD7..PD0)	<p>Port D is an 8-bit bi-directional I/O port with internal pull-up resistors (selected for each bit). The Port D output buffers have symmetrical drive characteristics with both high sink and source capability. As inputs, Port D pins that are externally pulled low will source current if the pull-up resistors are activated. The Port D pins are tri-stated when a reset condition becomes active, even if the clock is not running.</p> <p>Port D also serves the functions of various special features of the ATmega8 as listed on page 63.</p>
<u>RESET</u>	<p>Reset input. A low level on this pin for longer than the minimum pulse length will generate a reset, even if the clock is not running. The minimum pulse length is given in Table 15 on page 38. Shorter pulses are not guaranteed to generate a reset.</p>

**AV_{CC}**

AV_{CC} is the supply voltage pin for the A/D Converter, Port C (3..0), and ADC (7..6). It should be externally connected to V_{CC}, even if the ADC is not used. If the ADC is used, it should be connected to V_{CC} through a low-pass filter. Note that Port C (5..4) use digital supply voltage, V_{CC}.

AREF

AREF is the analog reference pin for the A/D Converter.

ADC7..6 (TQFP and QFN/MLF Package Only)

In the TQFP and QFN/MLF package, ADC7..6 serve as analog inputs to the A/D converter. These pins are powered from the analog supply and serve as 10-bit ADC channels.

Resources

A comprehensive set of development tools, application notes and datasheets are available for download on <http://www.atmel.com/avr>.



Register Summary

Address	Name	Bit 7	Bit 6	Bit 5	Bit 4	Bit 3	Bit 2	Bit 1	Bit 0	Page
0x3F (0x5F)	SREG	I	T	H	S	V	N	Z	C	11
0x3E (0x5E)	SPH	–	–	–	–	–	SP10	SP9	SP8	13
0x3D (0x5D)	SPL	SP7	SP6	SP5	SP4	SP3	SP2	SP1	SP0	13
0x3C (0x5C)	Reserved									
0x3B (0x5B)	GICR	INT1	INT0	–	–	–	–	IVSEL	IVCE	49, 67
0x3A (0x5A)	GIFR	INTF1	INTF0	–	–	–	–	–	–	68
0x39 (0x59)	TIMSK	OCIE2	TOIE2	TICIE1	OCIE1A	OCIE1B	TOIE1	–	TOIE0	72, 102, 122
0x38 (0x58)	TIFR	OCF2	TOV2	ICF1	OCF1A	OCF1B	TOV1	–	TOV0	73, 103, 122
0x37 (0x57)	SPMCR	SPMIE	RWWSB	–	RWWSRE	BLBSET	PGWRT	PGERS	SPMEN	213
0x36 (0x56)	TWCR	TWINT	TWEA	TWSTA	TWSTO	TWWC	TWEN	–	TWIE	171
0x35 (0x55)	MCUCR	SE	SM2	SM1	SM0	ISC11	ISC10	ISC01	ISC00	33, 66
0x34 (0x54)	MCUCSR	–	–	–	–	WDRF	BORF	EXTRF	PORF	41
0x33 (0x53)	TCCR0	–	–	–	–	–	CS02	CS01	CS00	72
0x32 (0x52)	TCNT0	Timer/Counter0 (8 Bits)								72
0x31 (0x51)	OSCCAL	Oscillator Calibration Register								31
0x30 (0x50)	SFIOR	–	–	–	–	ACME	PUD	PSR2	PSR10	58, 75, 123, 193
0x2F (0x4F)	TCCR1A	COM1A1	COM1A0	COM1B1	COM1B0	FOC1A	FOC1B	WGM11	WGM10	97
0x2E (0x4E)	TCCR1B	ICNC1	ICES1	–	WGM13	WGM12	CS12	CS11	CS10	100
0x2D (0x4D)	TCNT1H	Timer/Counter1 – Counter Register High byte								101
0x2C (0x4C)	TCNT1L	Timer/Counter1 – Counter Register Low byte								101
0x2B (0x4B)	OCR1AH	Timer/Counter1 – Output Compare Register A High byte								101
0x2A (0x4A)	OCR1AL	Timer/Counter1 – Output Compare Register A Low byte								101
0x29 (0x49)	OCR1BH	Timer/Counter1 – Output Compare Register B High byte								101
0x28 (0x48)	OCR1BL	Timer/Counter1 – Output Compare Register B Low byte								101
0x27 (0x47)	ICR1H	Timer/Counter1 – Input Capture Register High byte								102
0x26 (0x46)	ICR1L	Timer/Counter1 – Input Capture Register Low byte								102
0x25 (0x45)	TCCR2	FOC2	WGM20	COM21	COM20	WGM21	CS22	CS21	CS20	117
0x24 (0x44)	TCNT2	Timer/Counter2 (8 Bits)								119
0x23 (0x43)	OCR2	Timer/Counter2 Output Compare Register								119
0x22 (0x42)	ASSR	–	–	–	–	AS2	TCN2UB	OCR2UB	TCR2UB	119
0x21 (0x41)	WDTCSR	–	–	–	WDCE	WDE	WDP2	WDP1	WDP0	43
0x20 ⁽¹⁾ (0x40 ⁽¹⁾)	UBRRH	URSEL	–	–	–	UBRR[11:8]				158
	UCSRC	URSEL	UMSEL	UPM1	UPM0	USBS	UCSZ1	UCSZ0	UCPOL	156
0x1F (0x3F)	EEARH	–	–	–	–	–	–	–	EEAR8	20
0x1E (0x3E)	EEARL	EEAR7	EEAR6	EEAR5	EEAR4	EEAR3	EEAR2	EEAR1	EEAR0	20
0x1D (0x3D)	EEDR	EEPROM Data Register								20
0x1C (0x3C)	EEDR	–	–	–	–	EERIE	EEMWE	EEWE	EERE	20
0x1B (0x3B)	Reserved									
0x1A (0x3A)	Reserved									
0x19 (0x39)	Reserved									
0x18 (0x38)	PORTB	PORTB7	PORTB6	PORTB5	PORTB4	PORTB3	PORTB2	PORTB1	PORTB0	65
0x17 (0x37)	DDRB	DDB7	DDB6	DDB5	DDB4	DDB3	DDB2	DDB1	DDB0	65
0x16 (0x36)	PINB	PINB7	PINB6	PINB5	PINB4	PINB3	PINB2	PINB1	PINB0	65
0x15 (0x35)	PORTC	–	PORTC6	PORTC5	PORTC4	PORTC3	PORTC2	PORTC1	PORTC0	65
0x14 (0x34)	DDRC	–	DDC6	DDC5	DDC4	DDC3	DDC2	DDC1	DDC0	65
0x13 (0x33)	PINC	–	PINC6	PINC5	PINC4	PINC3	PINC2	PINC1	PINC0	65
0x12 (0x32)	PORTD	PORTD7	PORTD6	PORTD5	PORTD4	PORTD3	PORTD2	PORTD1	PORTD0	65
0x11 (0x31)	DDRD	DDD7	DDD6	DDD5	DDD4	DDD3	DDD2	DDD1	DDD0	65
0x10 (0x30)	PIND	PIND7	PIND6	PIND5	PIND4	PIND3	PIND2	PIND1	PIND0	65
0x0F (0x2F)	SPDR	SPI Data Register								131
0x0E (0x2E)	SPSR	SPIF	WCOL	–	–	–	–	–	SPI2X	131
0x0D (0x2D)	SPCR	SPIE	SPE	DORD	MSTR	CPOL	CPHA	SPR1	SPR0	129
0x0C (0x2C)	UDR	USART I/O Data Register								153
0x0B (0x2B)	UCSRA	RXC	TXC	UDRE	FE	DOR	PE	U2X	MPCM	154
0x0A (0x2A)	UCSRB	RXCIE	TXCIE	UDRIE	RXEN	TXEN	UCSZ2	RXB8	TXB8	155
0x09 (0x29)	UBRRL	USART Baud Rate Register Low byte								158
0x08 (0x28)	ACSR	ACD	ACBG	ACO	ACI	ACIE	ACIC	ACIS1	ACIS0	194
0x07 (0x27)	ADMUX	REFS1	REFS0	ADLAR	–	MUX3	MUX2	MUX1	MUX0	205
0x06 (0x26)	ADCSRA	ADEN	ADSC	ADFR	ADIF	ADIE	ADPS2	ADPS1	ADPS0	207
0x05 (0x25)	ADCH	ADC Data Register High byte								208
0x04 (0x24)	ADCL	ADC Data Register Low byte								208
0x03 (0x23)	TWDR	Two-wire Serial Interface Data Register								173
0x02 (0x22)	TWAR	TWA6	TWA5	TWA4	TWA3	TWA2	TWA1	TWA0	TWGCE	174

Register Summary (Continued)

Address	Name	Bit 7	Bit 6	Bit 5	Bit 4	Bit 3	Bit 2	Bit 1	Bit 0	Page
0x01 (0x21)	TWSR	TWS7	TWS6	TWS5	TWS4	TWS3	–	TWPS1	TWPS0	173
0x00 (0x20)	TWBR	Two-wire Serial Interface Bit Rate Register								171

- Notes:
1. Refer to the USART description for details on how to access UBRRH and UCSRC.
 2. For compatibility with future devices, reserved bits should be written to zero if accessed. Reserved I/O memory addresses should never be written.
 3. Some of the Status Flags are cleared by writing a logical one to them. Note that the CBI and SBI instructions will operate on all bits in the I/O Register, writing a one back into any flag read as set, thus clearing the flag. The CBI and SBI instructions work with registers 0x00 to 0x1F only.



Instruction Set Summary

Mnemonics	Operands	Description	Operation	Flags	#Clocks
ARITHMETIC AND LOGIC INSTRUCTIONS					
ADD	Rd, Rr	Add two Registers	$Rd \leftarrow Rd + Rr$	Z,C,N,V,H	1
ADC	Rd, Rr	Add with Carry two Registers	$Rd \leftarrow Rd + Rr + C$	Z,C,N,V,H	1
ADIW	Rd,K	Add Immediate to Word	$Rdh:Rdl \leftarrow Rdh:Rdl + K$	Z,C,N,V,S	2
SUB	Rd, Rr	Subtract two Registers	$Rd \leftarrow Rd - Rr$	Z,C,N,V,H	1
SUBI	Rd, K	Subtract Constant from Register	$Rd \leftarrow Rd - K$	Z,C,N,V,H	1
SBC	Rd, Rr	Subtract with Carry two Registers	$Rd \leftarrow Rd - Rr - C$	Z,C,N,V,H	1
SBCI	Rd, K	Subtract with Carry Constant from Reg.	$Rd \leftarrow Rd - K - C$	Z,C,N,V,H	1
SBIW	Rd,K	Subtract Immediate from Word	$Rdh:Rdl \leftarrow Rdh:Rdl - K$	Z,C,N,V,S	2
AND	Rd, Rr	Logical AND Registers	$Rd \leftarrow Rd \bullet Rr$	Z,N,V	1
ANDI	Rd, K	Logical AND Register and Constant	$Rd \leftarrow Rd \bullet K$	Z,N,V	1
OR	Rd, Rr	Logical OR Registers	$Rd \leftarrow Rd \vee Rr$	Z,N,V	1
ORI	Rd, K	Logical OR Register and Constant	$Rd \leftarrow Rd \vee K$	Z,N,V	1
EOR	Rd, Rr	Exclusive OR Registers	$Rd \leftarrow Rd \oplus Rr$	Z,N,V	1
COM	Rd	One's Complement	$Rd \leftarrow 0xFF - Rd$	Z,C,N,V	1
NEG	Rd	Two's Complement	$Rd \leftarrow 0x00 - Rd$	Z,C,N,V,H	1
SBR	Rd,K	Set Bit(s) in Register	$Rd \leftarrow Rd \vee K$	Z,N,V	1
CBR	Rd,K	Clear Bit(s) in Register	$Rd \leftarrow Rd \bullet (0xFF - K)$	Z,N,V	1
INC	Rd	Increment	$Rd \leftarrow Rd + 1$	Z,N,V	1
DEC	Rd	Decrement	$Rd \leftarrow Rd - 1$	Z,N,V	1
TST	Rd	Test for Zero or Minus	$Rd \leftarrow Rd \bullet Rd$	Z,N,V	1
CLR	Rd	Clear Register	$Rd \leftarrow Rd \oplus Rd$	Z,N,V	1
SER	Rd	Set Register	$Rd \leftarrow 0xFF$	None	1
MUL	Rd, Rr	Multiply Unsigned	$R1:R0 \leftarrow Rd \times Rr$	Z,C	2
MULS	Rd, Rr	Multiply Signed	$R1:R0 \leftarrow Rd \times Rr$	Z,C	2
MULSU	Rd, Rr	Multiply Signed with Unsigned	$R1:R0 \leftarrow Rd \times Rr$	Z,C	2
FMUL	Rd, Rr	Fractional Multiply Unsigned	$R1:R0 \leftarrow (Rd \times Rr) \lll 1$	Z,C	2
FMULS	Rd, Rr	Fractional Multiply Signed	$R1:R0 \leftarrow (Rd \times Rr) \lll 1$	Z,C	2
FMULSU	Rd, Rr	Fractional Multiply Signed with Unsigned	$R1:R0 \leftarrow (Rd \times Rr) \lll 1$	Z,C	2
BRANCH INSTRUCTIONS					
RJMP	k	Relative Jump	$PC \leftarrow PC + k + 1$	None	2
IJMP		Indirect Jump to (Z)	$PC \leftarrow Z$	None	2
RCALL	k	Relative Subroutine Call	$PC \leftarrow PC + k + 1$	None	3
ICALL		Indirect Call to (Z)	$PC \leftarrow Z$	None	3
RET		Subroutine Return	$PC \leftarrow STACK$	None	4
RETI		Interrupt Return	$PC \leftarrow STACK$	I	4
CPSE	Rd,Rr	Compare, Skip if Equal	if (Rd = Rr) $PC \leftarrow PC + 2$ or 3	None	1 / 2 / 3
CP	Rd,Rr	Compare	$Rd - Rr$	Z, N,V,C,H	1
CPC	Rd,Rr	Compare with Carry	$Rd - Rr - C$	Z, N,V,C,H	1
CPI	Rd,K	Compare Register with Immediate	$Rd - K$	Z, N,V,C,H	1
SBRC	Rr, b	Skip if Bit in Register Cleared	if (Rr(b)=0) $PC \leftarrow PC + 2$ or 3	None	1 / 2 / 3
SBRS	Rr, b	Skip if Bit in Register is Set	if (Rr(b)=1) $PC \leftarrow PC + 2$ or 3	None	1 / 2 / 3
SBIC	P, b	Skip if Bit in I/O Register Cleared	if (P(b)=0) $PC \leftarrow PC + 2$ or 3	None	1 / 2 / 3
SBIS	P, b	Skip if Bit in I/O Register is Set	if (P(b)=1) $PC \leftarrow PC + 2$ or 3	None	1 / 2 / 3
BRBS	s, k	Branch if Status Flag Set	if (SREG(s) = 1) $PC \leftarrow PC + k + 1$	None	1 / 2
BRBC	s, k	Branch if Status Flag Cleared	if (SREG(s) = 0) $PC \leftarrow PC + k + 1$	None	1 / 2
BREQ	k	Branch if Equal	if (Z = 1) $PC \leftarrow PC + k + 1$	None	1 / 2
BRNE	k	Branch if Not Equal	if (Z = 0) $PC \leftarrow PC + k + 1$	None	1 / 2
BRCS	k	Branch if Carry Set	if (C = 1) $PC \leftarrow PC + k + 1$	None	1 / 2
BRCC	k	Branch if Carry Cleared	if (C = 0) $PC \leftarrow PC + k + 1$	None	1 / 2
BRSH	k	Branch if Same or Higher	if (C = 0) $PC \leftarrow PC + k + 1$	None	1 / 2
BRLO	k	Branch if Lower	if (C = 1) $PC \leftarrow PC + k + 1$	None	1 / 2
BRMI	k	Branch if Minus	if (N = 1) $PC \leftarrow PC + k + 1$	None	1 / 2
BRPL	k	Branch if Plus	if (N = 0) $PC \leftarrow PC + k + 1$	None	1 / 2
BRGE	k	Branch if Greater or Equal, Signed	if (N ⊕ V = 0) $PC \leftarrow PC + k + 1$	None	1 / 2
BRLT	k	Branch if Less Than Zero, Signed	if (N ⊕ V = 1) $PC \leftarrow PC + k + 1$	None	1 / 2
BRHS	k	Branch if Half Carry Flag Set	if (H = 1) $PC \leftarrow PC + k + 1$	None	1 / 2
BRHC	k	Branch if Half Carry Flag Cleared	if (H = 0) $PC \leftarrow PC + k + 1$	None	1 / 2
BRTS	k	Branch if T Flag Set	if (T = 1) $PC \leftarrow PC + k + 1$	None	1 / 2
BRTC	k	Branch if T Flag Cleared	if (T = 0) $PC \leftarrow PC + k + 1$	None	1 / 2
BRVS	k	Branch if Overflow Flag is Set	if (V = 1) $PC \leftarrow PC + k + 1$	None	1 / 2
BRVC	k	Branch if Overflow Flag is Cleared	if (V = 0) $PC \leftarrow PC + k + 1$	None	1 / 2
Mnemonics	Operands	Description	Operation	Flags	#Clocks

Instruction Set Summary (Continued)

BRIE	k	Branch if Interrupt Enabled	$\text{if } (I = 1) \text{ then PC} \leftarrow \text{PC} + k + 1$	None	1 / 2
BRID	k	Branch if Interrupt Disabled	$\text{if } (I = 0) \text{ then PC} \leftarrow \text{PC} + k + 1$	None	1 / 2
DATA TRANSFER INSTRUCTIONS					
MOV	Rd, Rr	Move Between Registers	$\text{Rd} \leftarrow \text{Rr}$	None	1
MOVW	Rd, Rr	Copy Register Word	$\text{Rd+1:Rd} \leftarrow \text{Rr+1:Rr}$	None	1
LDI	Rd, K	Load Immediate	$\text{Rd} \leftarrow K$	None	1
LD	Rd, X	Load Indirect	$\text{Rd} \leftarrow (X)$	None	2
LD	Rd, X+	Load Indirect and Post-Inc.	$\text{Rd} \leftarrow (X), X \leftarrow X + 1$	None	2
LD	Rd, -X	Load Indirect and Pre-Dec.	$X \leftarrow X - 1, \text{Rd} \leftarrow (X)$	None	2
LD	Rd, Y	Load Indirect	$\text{Rd} \leftarrow (Y)$	None	2
LD	Rd, Y+	Load Indirect and Post-Inc.	$\text{Rd} \leftarrow (Y), Y \leftarrow Y + 1$	None	2
LD	Rd, -Y	Load Indirect and Pre-Dec.	$Y \leftarrow Y - 1, \text{Rd} \leftarrow (Y)$	None	2
LDD	Rd, Y+q	Load Indirect with Displacement	$\text{Rd} \leftarrow (Y + q)$	None	2
LD	Rd, Z	Load Indirect	$\text{Rd} \leftarrow (Z)$	None	2
LD	Rd, Z+	Load Indirect and Post-Inc.	$\text{Rd} \leftarrow (Z), Z \leftarrow Z + 1$	None	2
LD	Rd, -Z	Load Indirect and Pre-Dec.	$Z \leftarrow Z - 1, \text{Rd} \leftarrow (Z)$	None	2
LDD	Rd, Z+q	Load Indirect with Displacement	$\text{Rd} \leftarrow (Z + q)$	None	2
LDS	Rd, k	Load Direct from SRAM	$\text{Rd} \leftarrow (k)$	None	2
ST	X, Rr	Store Indirect	$(X) \leftarrow \text{Rr}$	None	2
ST	X+, Rr	Store Indirect and Post-Inc.	$(X) \leftarrow \text{Rr}, X \leftarrow X + 1$	None	2
ST	-X, Rr	Store Indirect and Pre-Dec.	$X \leftarrow X - 1, (X) \leftarrow \text{Rr}$	None	2
ST	Y, Rr	Store Indirect	$(Y) \leftarrow \text{Rr}$	None	2
ST	Y+, Rr	Store Indirect and Post-Inc.	$(Y) \leftarrow \text{Rr}, Y \leftarrow Y + 1$	None	2
ST	-Y, Rr	Store Indirect and Pre-Dec.	$Y \leftarrow Y - 1, (Y) \leftarrow \text{Rr}$	None	2
STD	Y+q, Rr	Store Indirect with Displacement	$(Y + q) \leftarrow \text{Rr}$	None	2
ST	Z, Rr	Store Indirect	$(Z) \leftarrow \text{Rr}$	None	2
ST	Z+, Rr	Store Indirect and Post-Inc.	$(Z) \leftarrow \text{Rr}, Z \leftarrow Z + 1$	None	2
ST	-Z, Rr	Store Indirect and Pre-Dec.	$Z \leftarrow Z - 1, (Z) \leftarrow \text{Rr}$	None	2
STD	Z+q, Rr	Store Indirect with Displacement	$(Z + q) \leftarrow \text{Rr}$	None	2
STS	k, Rr	Store Direct to SRAM	$(k) \leftarrow \text{Rr}$	None	2
LPM		Load Program Memory	$\text{R0} \leftarrow (Z)$	None	3
LPM	Rd, Z	Load Program Memory	$\text{Rd} \leftarrow (Z)$	None	3
LPM	Rd, Z+	Load Program Memory and Post-Inc	$\text{Rd} \leftarrow (Z), Z \leftarrow Z + 1$	None	3
SPM		Store Program Memory	$(Z) \leftarrow \text{R1:R0}$	None	-
IN	Rd, P	In Port	$\text{Rd} \leftarrow P$	None	1
OUT	P, Rr	Out Port	$P \leftarrow \text{Rr}$	None	1
PUSH	Rr	Push Register on Stack	$\text{STACK} \leftarrow \text{Rr}$	None	2
POP	Rd	Pop Register from Stack	$\text{Rd} \leftarrow \text{STACK}$	None	2
BIT AND BIT-TEST INSTRUCTIONS					
SBI	P, b	Set Bit in I/O Register	$\text{I/O}(P, b) \leftarrow 1$	None	2
CBI	P, b	Clear Bit in I/O Register	$\text{I/O}(P, b) \leftarrow 0$	None	2
LSL	Rd	Logical Shift Left	$\text{Rd}(n+1) \leftarrow \text{Rd}(n), \text{Rd}(0) \leftarrow 0$	Z, C, N, V	1
LSR	Rd	Logical Shift Right	$\text{Rd}(n) \leftarrow \text{Rd}(n+1), \text{Rd}(7) \leftarrow 0$	Z, C, N, V	1
ROL	Rd	Rotate Left Through Carry	$\text{Rd}(0) \leftarrow \text{C}, \text{Rd}(n+1) \leftarrow \text{Rd}(n), \text{C} \leftarrow \text{Rd}(7)$	Z, C, N, V	1
ROR	Rd	Rotate Right Through Carry	$\text{Rd}(7) \leftarrow \text{C}, \text{Rd}(n) \leftarrow \text{Rd}(n+1), \text{C} \leftarrow \text{Rd}(0)$	Z, C, N, V	1
ASR	Rd	Arithmetic Shift Right	$\text{Rd}(n) \leftarrow \text{Rd}(n+1), n=0..6$	Z, C, N, V	1
SWAP	Rd	Swap Nibbles	$\text{Rd}(3..0) \leftarrow \text{Rd}(7..4), \text{Rd}(7..4) \leftarrow \text{Rd}(3..0)$	None	1
BSET	s	Flag Set	$\text{SREG}(s) \leftarrow 1$	SREG(s)	1
BCLR	s	Flag Clear	$\text{SREG}(s) \leftarrow 0$	SREG(s)	1
BST	Rr, b	Bit Store from Register to T	$T \leftarrow \text{Rr}(b)$	T	1
BLD	Rd, b	Bit load from T to Register	$\text{Rd}(b) \leftarrow T$	None	1
SEC		Set Carry	$C \leftarrow 1$	C	1
CLC		Clear Carry	$C \leftarrow 0$	C	1
SEN		Set Negative Flag	$N \leftarrow 1$	N	1
CLN		Clear Negative Flag	$N \leftarrow 0$	N	1
SEZ		Set Zero Flag	$Z \leftarrow 1$	Z	1
CLZ		Clear Zero Flag	$Z \leftarrow 0$	Z	1
SEI		Global Interrupt Enable	$I \leftarrow 1$	I	1
CLI		Global Interrupt Disable	$I \leftarrow 0$	I	1
SES		Set Signed Test Flag	$S \leftarrow 1$	S	1
CLS		Clear Signed Test Flag	$S \leftarrow 0$	S	1
SEV		Set Twos Complement Overflow.	$V \leftarrow 1$	V	1
CLV		Clear Twos Complement Overflow	$V \leftarrow 0$	V	1
SET		Set T in SREG	$T \leftarrow 1$	T	1
Mnemonics	Operands	Description	Operation	Flags	#Clocks



Instruction Set Summary (Continued)

CLT		Clear T in SREG	T ← 0	T	1
SEH		Set Half Carry Flag in SREG	H ← 1	H	1
CLH		Clear Half Carry Flag in SREG	H ← 0	H	1
MCU CONTROL INSTRUCTIONS					
NOP		No Operation		None	1
SLEEP		Sleep	(see specific descr. for Sleep function)	None	1
WDR		Watchdog Reset	(see specific descr. for WDR/timer)	None	1

Ordering Information

Speed (MHz)	Power Supply	Ordering Code	Package ⁽¹⁾	Operation Range
8	2.7 - 5.5	ATmega8L-8AC	32A	Commercial (0°C to 70°C)
		ATmega8L-8PC	28P3	
		ATmega8L-8MC	32M1-A	
		ATmega8L-8AI	32A	Industrial (-40°C to 85°C)
		ATmega8L-8AU ⁽²⁾	32A	
		ATmega8L-8PI	28P3	
ATmega8L-8PU ⁽²⁾	28P3			
ATmega8L-8MI	32M1-A	32M1-A		
ATmega8L-8MU ⁽²⁾	32M1-A			
16	4.5 - 5.5	ATmega8-16AC	32A	Commercial (0°C to 70°C)
		ATmega8-16PC	28P3	
		ATmega8-16MC	32M1-A	
		ATmega8-16AI	32A	Industrial (-40°C to 85°C)
		ATmega8-16AU ⁽²⁾	32A	
		ATmega8-16PI	28P3	
ATmega8-16PU ⁽²⁾	28P3			
ATmega8-16MI	32M1-A	32M1-A		
ATmega8-16MU ⁽²⁾	32M1-A			

- Notes:
1. This device can also be supplied in wafer form. Please contact your local Atmel sales office for detailed ordering information and minimum quantities.
 2. Pb-free packaging alternative, complies to the European Directive for Restriction of Hazardous Substances (RoHS directive). Also Halide free and fully Green.

Package Type	
32A	32-lead, Thin (1.0 mm) Plastic Quad Flat Package (TQFP)
28P3	28-lead, 0.300" Wide, Plastic Dual Inline Package (PDIP)
32M1-A	32-pad, 5 x 5 x 1.0 body, Lead Pitch 0.50 mm Quad Flat No-Lead/Micro Lead Frame Package (QFN/MLF)



Packaging Information

32A

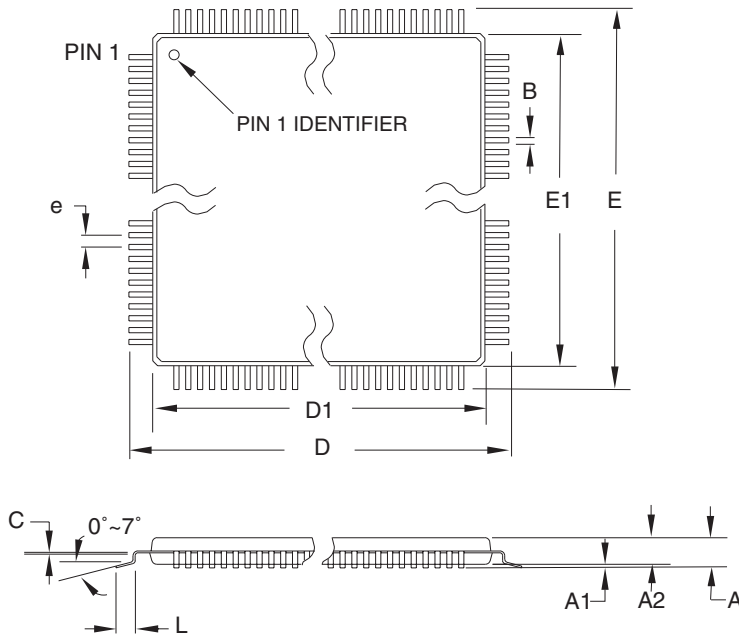

COMMON DIMENSIONS
(Unit of Measure = mm)

SYMBOL	MIN	NOM	MAX	NOTE
A	–	–	1.20	
A1	0.05	–	0.15	
A2	0.95	1.00	1.05	
D	8.75	9.00	9.25	
D1	6.90	7.00	7.10	Note 2
E	8.75	9.00	9.25	
E1	6.90	7.00	7.10	Note 2
B	0.30	–	0.45	
C	0.09	–	0.20	
L	0.45	–	0.75	
e	0.80 TYP			

- Notes:
1. This package conforms to JEDEC reference MS-026, Variation ABA.
 2. Dimensions D1 and E1 do not include mold protrusion. Allowable protrusion is 0.25 mm per side. Dimensions D1 and E1 are maximum plastic body size dimensions including mold mismatch.
 3. Lead coplanarity is 0.10 mm maximum.

10/5/2001

ATMEL 2325 Orchard Parkway
San Jose, CA 95131

TITLE
32A, 32-lead, 7 x 7 mm Body Size, 1.0 mm Body Thickness,
0.8 mm Lead Pitch, Thin Profile Plastic Quad Flat Package (TQFP)

DRAWING NO.	REV.
32A	B

28P3

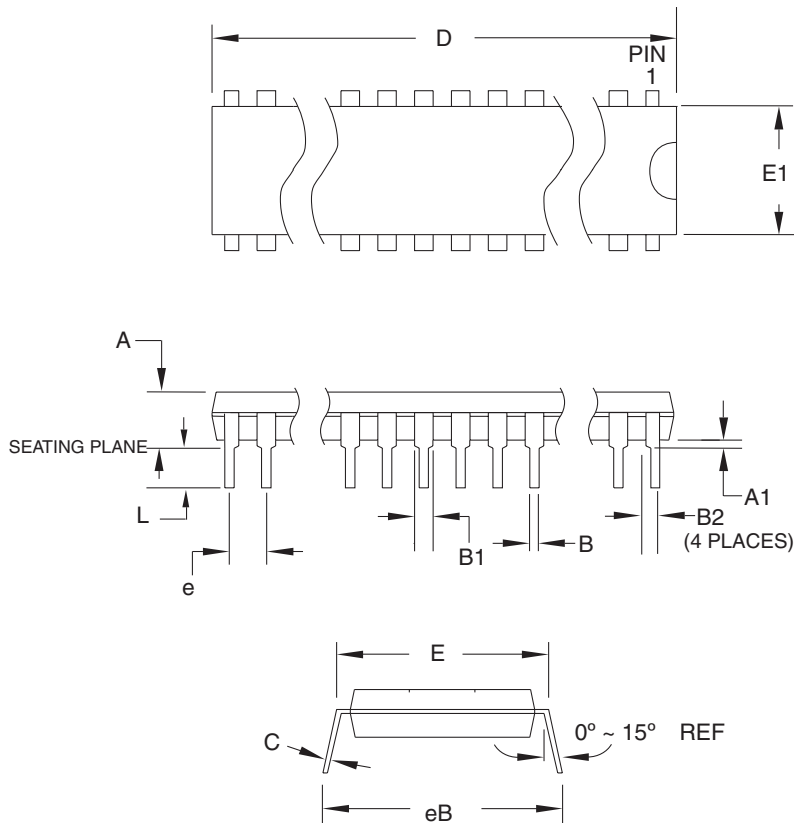

COMMON DIMENSIONS (Unit of Measure = mm)

SYMBOL	MIN	NOM	MAX	NOTE
A	-	-	4.5724	
A1	0.508	-	-	
D	34.544	-	34.798	Note 1
E	7.620	-	8.255	
E1	7.112	-	7.493	Note 1
B	0.381	-	0.533	
B1	1.143	-	1.397	
B2	0.762	-	1.143	
L	3.175	-	3.429	
C	0.203	-	0.356	
eB	-	-	10.160	
e	2.540 TYP			

Note: 1. Dimensions D and E1 do not include mold Flash or Protrusion.
Mold Flash or Protrusion shall not exceed 0.25 mm (0.010").

09/28/01

ATMEL 2325 Orchard Parkway
San Jose, CA 95131

TITLE
28P3, 28-lead (0.300"/7.62 mm Wide) Plastic Dual
Inline Package (PDIP)

DRAWING NO.
28P3

REV.
B

32M1-A

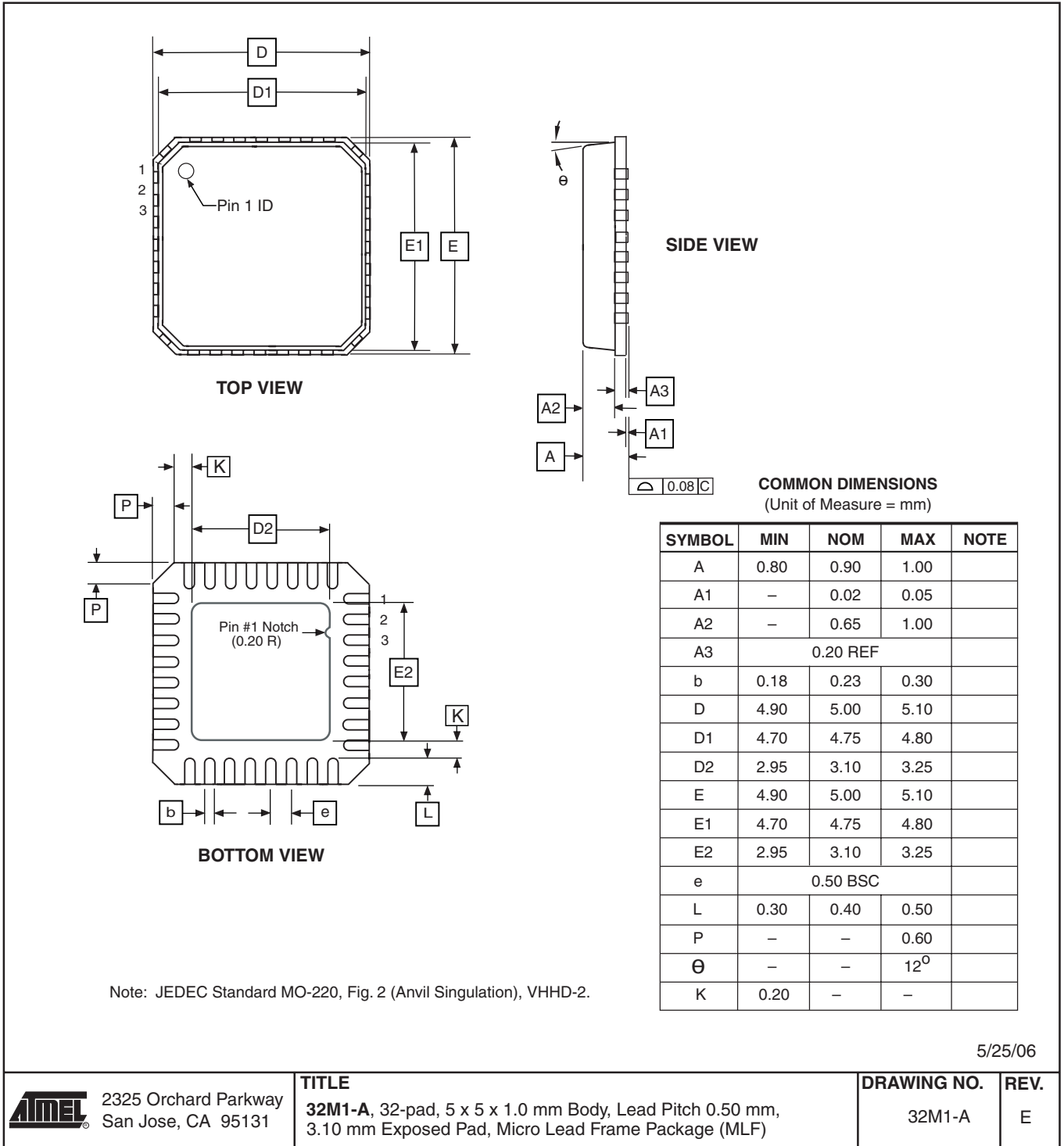

Erratas

The revision letter in this section refers to the revision of the ATmega8 device.

ATmega8 Rev. D to I

- **First Analog Comparator conversion may be delayed**
- **Interrupts may be lost when writing the timer registers in the asynchronous timer**
- **Signature may be Erased in Serial Programming Mode**
- **CKOPT Does not Enable Internal Capacitors on XTALn/TOSCn Pins when 32 KHz Oscillator is Used to Clock the Asynchronous Timer/Counter2**

1. **First Analog Comparator conversion may be delayed**

If the device is powered by a slow rising V_{CC} , the first Analog Comparator conversion will take longer than expected on some devices.

Problem Fix/Workaround

When the device has been powered or reset, disable then enable the Analog Comparator before the first conversion.

2. **Interrupts may be lost when writing the timer registers in the asynchronous timer**

If one of the timer registers which is synchronized to the asynchronous timer2 clock is written in the cycle before a overflow interrupt occurs, the interrupt may be lost.

Problem Fix/Workaround

Always check that the Timer2 Timer/Counter register, TCNT2, does not have the value 0xFF before writing the Timer2 Control Register, TCCR2, or Output Compare Register, OCR2

3. **Signature may be Erased in Serial Programming Mode**

If the signature bytes are read before a chip erase command is completed, the signature may be erased causing the device ID and calibration bytes to disappear. This is critical, especially, if the part is running on internal RC oscillator.

Problem Fix/Workaround:

Ensure that the chip erase command has exceeded before applying the next command.

4. **CKOPT Does not Enable Internal Capacitors on XTALn/TOSCn Pins when 32 KHz Oscillator is Used to Clock the Asynchronous Timer/Counter2**

When the internal RC Oscillator is used as the main clock source, it is possible to run the Timer/Counter2 asynchronously by connecting a 32 KHz Oscillator between XTAL1/TOSC1 and XTAL2/TOSC2. But when the internal RC Oscillator is selected as the main clock source, the CKOPT Fuse does not control the internal capacitors on XTAL1/TOSC1 and XTAL2/TOSC2. As long as there are no capacitors connected to XTAL1/TOSC1 and XTAL2/TOSC2, safe operation of the Oscillator is not guaranteed.

Problem fix/Workaround

Use external capacitors in the range of 20 - 36 pF on XTAL1/TOSC1 and XTAL2/TOSC2. This will be fixed in ATmega8 Rev. G where the CKOPT Fuse will control internal capacitors also when internal RC Oscillator is selected as main clock source. For ATmega8 Rev. G, CKOPT = 0 (programmed) will enable the internal capacitors on XTAL1 and XTAL2. Customers who want compatibility between Rev. G and older revisions, must ensure that CKOPT is unprogrammed (CKOPT = 1).



Datasheet Revision History

Please note that the referring page numbers in this section are referred to this document. The referring revision in this section are referring to the document revision.

Changes from Rev. 2486P- 02/06 to Rev. 2486Q- 10/06

1. Updated “Timer/Counter Oscillator” on page 32.
2. Updated “Fast PWM Mode” on page 89.
3. Updated code example in “USART Initialization” on page 138.
4. Updated Table 37 on page 98, Table 39 on page 99, Table 42 on page 117, Table 44 on page 118, and Table 98 on page 240.
5. Updated “Erratas” on page 17.

Changes from Rev. 2486O-10/04 to Rev. 2486P- 02/06

1. Added “Resources” on page 7.
2. Updated “External Clock” on page 32.
3. Updated “Serial Peripheral Interface – SPI” on page 124.
4. Updated Code Example in “USART Initialization” on page 138.
5. Updated Note in “Bit Rate Generator Unit” on page 170.
6. Updated Table 98 on page 240.
7. Updated Note in Table 103 on page 248.
8. Updated “Erratas” on page 17.

Changes from Rev. 2486N-09/04 to Rev. 2486O-10/04

1. Removed to instances of “analog ground”. Replaced by “ground”.
2. Updated Table 7 on page 29, Table 15 on page 38, and Table 100 on page 244.
3. Updated “Calibrated Internal RC Oscillator” on page 30 with the 1 MHz default value.
4. Table 89 on page 225 and Table 90 on page 225 moved to new section “Page Size” on page 225.
5. Updated descripton for bit 4 in “Store Program Memory Control Register – SPMCR” on page 213.
6. Updated “Ordering Information” on page 13.

Changes from Rev. 2486M-12/03 to Rev. 2486N-09/04

1. Added note to MLF package in “Pin Configurations” on page 2.
2. Updated “Internal Voltage Reference Characteristics” on page 42.
3. Updated “DC Characteristics” on page 242.

4. ADC4 and ADC5 support 10-bit accuracy. Document updated to reflect this. Updated features in “Analog-to-Digital Converter” on page 196. Updated “ADC Characteristics” on page 248.
5. Removed reference to “External RC Oscillator application note” from “External RC Oscillator” on page 29.

Changes from Rev. 2486L-10/03 to Rev. 2486M-12/03

1. Updated “Calibrated Internal RC Oscillator” on page 30.

Changes from Rev. 2486K-08/03 to Rev. 2486L-10/03

1. Removed “Preliminary” and TBDs from the datasheet.
2. Renamed ICP to ICP1 in the datasheet.
3. Removed instructions CALL and JMP from the datasheet.
4. Updated t_{RST} in Table 15 on page 38, V_{BG} in Table 16 on page 42, Table 100 on page 244 and Table 102 on page 246.
5. Replaced text “XTAL1 and XTAL2 should be left unconnected (NC)” after Table 9 in “Calibrated Internal RC Oscillator” on page 30. Added text regarding XTAL1/XTAL2 and CKOPT Fuse in “Timer/Counter Oscillator” on page 32.
6. Updated Watchdog Timer code examples in “Timed Sequences for Changing the Configuration of the Watchdog Timer” on page 45.
7. Removed bit 4, ADHSM, from “Special Function IO Register – SFIOR” on page 58.
8. Added note 2 to Figure 103 on page 215.
9. Updated item 4 in the “Serial Programming Algorithm” on page 238.
10. Added t_{WD_FUSE} to Table 97 on page 239 and updated Read Calibration Byte, Byte 3, in Table 98 on page 240.
11. Updated Absolute Maximum Ratings* and DC Characteristics in “Electrical Characteristics” on page 242.

Changes from Rev. 2486J-02/03 to Rev. 2486K-08/03

1. Updated V_{BOT} values in Table 15 on page 38.
2. Updated “ADC Characteristics” on page 248.
3. Updated “ATmega8 Typical Characteristics” on page 249.
4. Updated “Erratas” on page 17.

Changes from Rev. 2486I-12/02 to Rev. 2486J-02/03

1. Improved the description of “Asynchronous Timer Clock – clk_{ASY} ” on page 26.
2. Removed reference to the “Multipurpose Oscillator” application note and the “32 kHz Crystal Oscillator” application note, which do not exist.



3. Corrected OCn waveforms in Figure 38 on page 90.
4. Various minor Timer 1 corrections.
5. Various minor TWI corrections.
6. Added note under “Filling the Temporary Buffer (Page Loading)” on page 216 about writing to the EEPROM during an SPM Page load.
7. Removed ADHSM completely.
8. Added section “EEPROM Write during Power-down Sleep Mode” on page 23.
9. Removed XTAL1 and XTAL2 description on page 5 because they were already described as part of “Port B (PB7..PB0) XTAL1/XTAL2/TOSC1/TOSC2” on page 5.
10. Improved the table under “SPI Timing Characteristics” on page 246 and removed the table under “SPI Serial Programming Characteristics” on page 241.
11. Corrected PC6 in “Alternate Functions of Port C” on page 61.
12. Corrected PB6 and PB7 in “Alternate Functions of Port B” on page 58.
13. Corrected 230.4 Mbps to 230.4 kbps under “Examples of Baud Rate Setting” on page 159.
14. Added information about PWM symmetry for Timer 2 in “Phase Correct PWM Mode” on page 113.
15. Added thick lines around accessible registers in Figure 76 on page 169.
16. Changed “will be ignored” to “must be written to zero” for unused Z-pointer bits under “Performing a Page Write” on page 216.
17. Added note for RSTDISBL Fuse in Table 87 on page 223.
18. Updated drawings in “Packaging Information” on page 14.

**Changes from Rev.
2486H-09/02 to Rev.
2486I-12/02**

1. Added errata for Rev D, E, and F on page 17.

**Changes from Rev.
2486G-09/02 to Rev.
2486H-09/02**

1. Changed the Endurance on the Flash to 10,000 Write/Erase Cycles.

**Changes from Rev.
2486F-07/02 to Rev.
2486G-09/02**

- 1 Updated Table 103, “ADC Characteristics,” on page 248.

Changes from Rev. 2486E-06/02 to Rev. 2486F-07/02

- 1 **Changes in “Digital Input Enable and Sleep Modes” on page 55.**
- 2 **Addition of OCS2 in “MOSI/OC2 – Port B, Bit 3” on page 59.**
- 3 **The following tables has been updated:**
Table 51, “CPOL and CPHA Functionality,” on page 132, Table 59, “UCPOL Bit Settings,” on page 158, Table 72, “Analog Comparator Multiplexed Input⁽¹⁾,” on page 195, Table 73, “ADC Conversion Time,” on page 200, Table 75, “Input Channel Selections,” on page 206, and Table 84, “Explanation of Different Variables used in Figure 103 and the Mapping to the Z-pointer,” on page 221.
- 5 **Changes in “Reading the Calibration Byte” on page 234.**
- 6 **Corrected Errors in Cross References.**

Changes from Rev. 2486D-03/02 to Rev. 2486E-06/02

- 1 **Updated Some Preliminary Test Limits and Characterization Data**
The following tables have been updated:
Table 15, “Reset Characteristics,” on page 38, Table 16, “Internal Voltage Reference Characteristics,” on page 42, DC Characteristics on page 242, Table , “ADC Characteristics,” on page 248.
- 2 **Changes in External Clock Frequency**
Added the description at the end of “External Clock” on page 32.
Added period changing data in Table 99, “External Clock Drive,” on page 244.
- 3 **Updated TWI Chapter**
More details regarding use of the TWI bit rate prescaler and a Table 65, “TWI Bit Rate Prescaler,” on page 173.

Changes from Rev. 2486C-03/02 to Rev. 2486D-03/02

- 1 **Updated Typical Start-up Times.**
The following tables has been updated:
Table 5, “Start-up Times for the Crystal Oscillator Clock Selection,” on page 28, Table 6, “Start-up Times for the Low-frequency Crystal Oscillator Clock Selection,” on page 28, Table 8, “Start-up Times for the External RC Oscillator Clock Selection,” on page 29, and Table 12, “Start-up Times for the External Clock Selection,” on page 32.
- 2 **Added “ATmega8 Typical Characteristics” on page 249.**

Changes from Rev. 2486B-12/01 to Rev. 2486C-03/02

- 1 **Updated TWI Chapter.**
More details regarding use of the TWI Power-down operation and using the TWI as Master with low TWBRR values are added into the datasheet.
Added the note at the end of the “Bit Rate Generator Unit” on page 170.
Added the description at the end of “Address Match Unit” on page 170.
- 2 **Updated Description of OSCCAL Calibration Byte.**
In the datasheet, it was not explained how to take advantage of the calibration bytes for 2, 4, and 8 MHz Oscillator selections. This is now added in the following sections:



Improved description of “Oscillator Calibration Register – OSCCAL” on page 31 and “Calibration Byte” on page 225.

3 Added Some Preliminary Test Limits and Characterization Data.

Removed some of the TBD’s in the following tables and pages:

Table 3 on page 26, Table 15 on page 38, Table 16 on page 42, Table 17 on page 44, “ $T_A = -40^{\circ}\text{C}$ to 85°C , $V_{CC} = 2.7\text{V}$ to 5.5V (unless otherwise noted)” on page 242, Table 99 on page 244, and Table 102 on page 246.

4 Updated Programming Figures.

Figure 104 on page 226 and Figure 112 on page 237 are updated to also reflect that AV_{CC} must be connected during Programming mode.

5 Added a Description on how to Enter Parallel Programming Mode if RESET Pin is Disabled or if External Oscillators are Selected.

Added a note in section “Enter Programming Mode” on page 228.



Atmel Corporation

2325 Orchard Parkway
San Jose, CA 95131, USA
Tel: 1(408) 441-0311
Fax: 1(408) 487-2600

Regional Headquarters

Europe

Atmel Sarl
Route des Arsenaux 41
Case Postale 80
CH-1705 Fribourg
Switzerland
Tel: (41) 26-426-5555
Fax: (41) 26-426-5500

Asia

Room 1219
Chinachem Golden Plaza
77 Mody Road Tsimshatsui
East Kowloon
Hong Kong
Tel: (852) 2721-9778
Fax: (852) 2722-1369

Japan

9F, Tonetsu Shinkawa Bldg.
1-24-8 Shinkawa
Chuo-ku, Tokyo 104-0033
Japan
Tel: (81) 3-3523-3551
Fax: (81) 3-3523-7581

Atmel Operations

Memory

2325 Orchard Parkway
San Jose, CA 95131, USA
Tel: 1(408) 441-0311
Fax: 1(408) 436-4314

Microcontrollers

2325 Orchard Parkway
San Jose, CA 95131, USA
Tel: 1(408) 441-0311
Fax: 1(408) 436-4314

La Chantrerie
BP 70602
44306 Nantes Cedex 3, France
Tel: (33) 2-40-18-18-18
Fax: (33) 2-40-18-19-60

ASIC/ASSP/Smart Cards

Zone Industrielle
13106 Rousset Cedex, France
Tel: (33) 4-42-53-60-00
Fax: (33) 4-42-53-60-01

1150 East Cheyenne Mtn. Blvd.
Colorado Springs, CO 80906, USA
Tel: 1(719) 576-3300
Fax: 1(719) 540-1759

Scottish Enterprise Technology Park
Maxwell Building
East Kilbride G75 0QR, Scotland
Tel: (44) 1355-803-000
Fax: (44) 1355-242-743

RF/Automotive

Theresienstrasse 2
Postfach 3535
74025 Heilbronn, Germany
Tel: (49) 71-31-67-0
Fax: (49) 71-31-67-2340

1150 East Cheyenne Mtn. Blvd.
Colorado Springs, CO 80906, USA
Tel: 1(719) 576-3300
Fax: 1(719) 540-1759

Biometrics/Imaging/Hi-Rel MPU/ High Speed Converters/RF Datacom

Avenue de Rochepleine
BP 123
38521 Saint-Egreve Cedex, France
Tel: (33) 4-76-58-30-00
Fax: (33) 4-76-58-34-80

Literature Requests

www.atmel.com/literature

Disclaimer: The information in this document is provided in connection with Atmel products. No license, express or implied, by estoppel or otherwise, to any intellectual property right is granted by this document or in connection with the sale of Atmel products. **EXCEPT AS SET FORTH IN ATMEL'S TERMS AND CONDITIONS OF SALE LOCATED ON ATMEL'S WEB SITE, ATMEL ASSUMES NO LIABILITY WHATSOEVER AND DISCLAIMS ANY EXPRESS, IMPLIED OR STATUTORY WARRANTY RELATING TO ITS PRODUCTS INCLUDING, BUT NOT LIMITED TO, THE IMPLIED WARRANTY OF MERCHANTABILITY, FITNESS FOR A PARTICULAR PURPOSE, OR NON-INFRINGEMENT. IN NO EVENT SHALL ATMEL BE LIABLE FOR ANY DIRECT, INDIRECT, CONSEQUENTIAL, PUNITIVE, SPECIAL OR INCIDENTAL DAMAGES (INCLUDING, WITHOUT LIMITATION, DAMAGES FOR LOSS OF PROFITS, BUSINESS INTERRUPTION, OR LOSS OF INFORMATION) ARISING OUT OF THE USE OR INABILITY TO USE THIS DOCUMENT, EVEN IF ATMEL HAS BEEN ADVISED OF THE POSSIBILITY OF SUCH DAMAGES.** Atmel makes no representations or warranties with respect to the accuracy or completeness of the contents of this document and reserves the right to make changes to specifications and product descriptions at any time without notice. Atmel does not make any commitment to update the information contained herein. Atmel's products are not intended, authorized, or warranted for use as components in applications intended to support or sustain life.

© 2006 Atmel Corporation. All rights reserved. ATMEL®, logo and combinations thereof, Everywhere You Are®, AVR®, AVR Studio®, and others are the registered trademarks or trademarks of Atmel Corporation or its subsidiaries. Other terms and product names may be trademarks of others.