

**PLEASE CHECK WWW.MOLEX.COM FOR LATEST PART INFORMATION**

**Part Number:** [0353170226](#)  
**Status:** **Active**  
**Overview:** [minifit\\_jr](#)  
**Description:** 4.20mm (.165") Pitch Mini-Fit® Header, Dual Row, Vertical, 2 Circuits, PA Polyamide (Nylon) 6/6 94V-2, Green

**Documents:**

[3D Model](#) [RoHS Certificate of Compliance \(PDF\)](#)  
[Drawing \(PDF\)](#)

**Agency Certification**

CSA LR19980  
 UL E29179

**General**

Product Family PCB Headers  
 Series [35317](#)  
 Application Wire-to-Board  
 Comments Current = 13A max. per circuit when header is mated to a receptacle loaded with [45750](#) Mini-Fit Plus HCS™ Crimp Terminal Crimped to to 16 AWG wire. . See Molex product specification PS-45750-001 for additional current de-rating information.

Overview [minifit\\_jr](#)  
 Product Name Mini-Fit®

**Physical**

Breakaway No  
 Circuits (Loaded) 2  
 Circuits (maximum) 2  
 Color - Resin Natural  
 Durability (mating cycles max) 30  
 First Mate / Last Break No  
 Flammability 94V-2  
 Glow-Wire Compliant No  
 Guide to Mating Part No  
 Keying to Mating Part None  
 Lock to Mating Part Yes  
 Material - Plating Mating Tin  
 Material - Plating Termination Tin  
 Material - Resin Nylon  
 Number of Rows 2  
 Orientation Vertical  
 PC Tail Length (in) 0.138 In  
 PC Tail Length (mm) 3.50 mm  
 PCB Locator Yes  
 PCB Retention None  
 PCB Thickness Recommended (in) 0.062 In  
 PCB Thickness Recommended (mm) 1.60 mm  
 Packaging Type Bag  
 Pitch - Mating Interface (in) 0.165 In  
 Pitch - Mating Interface (mm) 4.20 mm  
 Polarized to PCB No  
 Shrouded Partial  
 Stackable No  
 Surface Mount Compatible (SMC) No

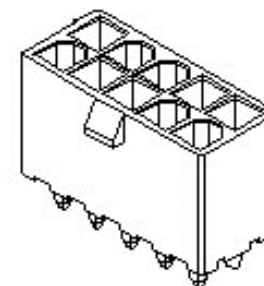

*image - Reference only*

*Series*

**EU RoHS**

**ELV and RoHS Compliant**  
**REACH SVHC**  
 Not Reviewed  
**Halogen-Free Status**

**China RoHS**



**Halogen-Free**

**Need more information on product environmental compliance?**

Email [productcompliance@molex.com](mailto:productcompliance@molex.com)  
 For a multiple part number RoHS Certificate of Compliance, [click here](#)

Please visit the [Contact Us](#) section for any non-product compliance questions.

**Search Parts in this Series**

[35317Series](#)

**Mates With**

[5557](#) Mini-Fit Jr.™ Receptacle Housing

Temperature Range - Operating	-40°C to +105°C
Termination Interface: Style	Through Hole

**Electrical**

Current - Maximum per Contact	13A
Voltage - Maximum	250V

**Material Info****Reference - Drawing Numbers**

Packaging Specification	PK-35317-001
Product Specification	RPS-35317-001
Sales Drawing	SD-35317-001

This document was generated on 05/24/2010

**PLEASE CHECK [WWW.MOLEX.COM](http://WWW.MOLEX.COM) FOR LATEST PART INFORMATION**

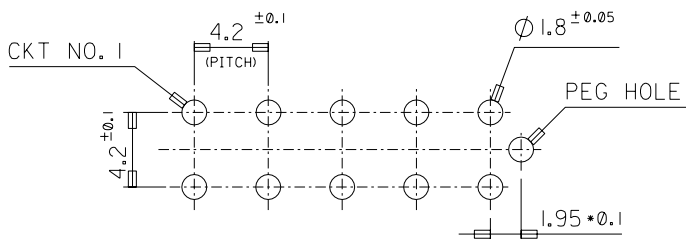
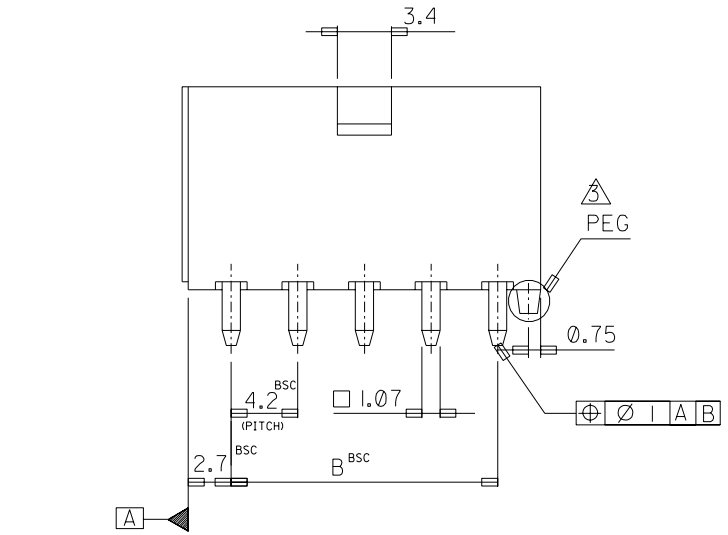
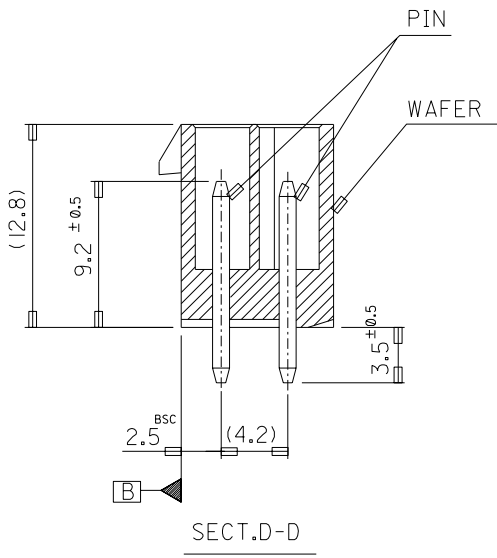
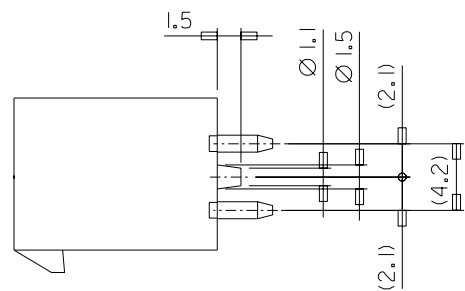
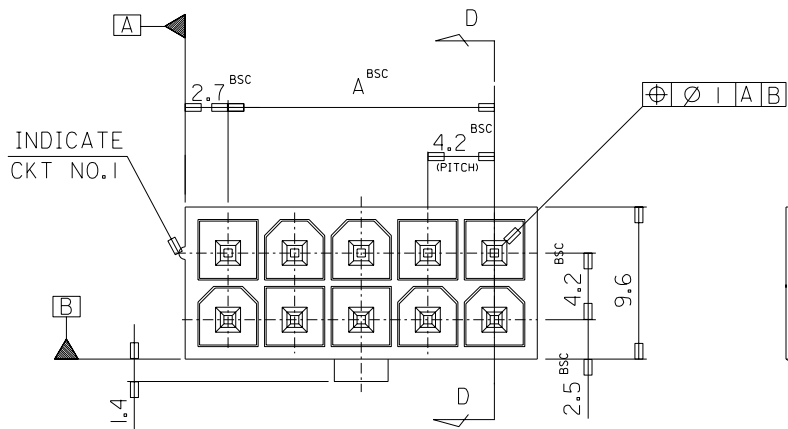

RECOMMENDED P.C.BOARD PATTERN

REVISED  
KOR2003-0259  
K.S.KIM 2003.5.23  
J.K.OH  
C.W.LEE

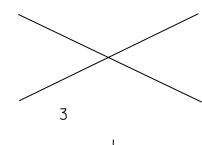

3:1 X  
D.J.KIM 1993.05.01  
J.K.OH  
C.W.LEE

NOTES

1. WHEN MATED WITH 5557-NR TO BE SURELY LOCKED.
  2. MATERIAL: WAFER — NYLON66 UL94V-0  
NYLON66 UL94V-2  
PIN — BRASS(TIN PLATED)
- △ MOLD PEG IS 35317-\*\*\*3\*, -\*\*\*4\* ONLY.

LEGEND

35317 - \*\* \* \*  
 COLOR - 0:NATURAL  
 1:BLACK  
 2:RED  
 3:YELLOW  
 4:BLUE  
 6:GREEN  
 7:BROWN  
 1:NYLON66 UL94V-0  
 2:NYLON66 UL94V-2  
 3:NYLON66 UL94V-0(WITH PEG)  
 4:NYLON66 UL94V-2(WITH PEG)  
 CKT

46.2	3531724**	35317 -24**	24
42.0	3531722**	-22**	22
37.8	3531720**	-20**	20
33.6	3531718**	-18**	18
29.4	3531716**	-16**	16
25.2	3531714**	-14**	14
21.0	3531712**	-12**	12
16.8	3531710**	-10**	10
12.6	3531708**	-08**	8
8.4	3531706**	-06**	6
4.2	3531704**	-04**	4
—	3531702**	35317 -02**	2
A	Material No.	ENG. NO.	CIRCUIT

NEW MINIFIT CONN.  
WAFER ASS'Y